

UNCLASSIFIED

AD NUMBER

AD817071

LIMITATION CHANGES

TO:

Approved for public release; distribution is unlimited.

FROM:

Distribution: Further dissemination only as directed by Army Materiel Command, Alexandria, VA, APR 1967, or higher DoD authority.

AUTHORITY

USAMC ltr, 2 Jul 1973

THIS PAGE IS UNCLASSIFIED

**PROPERTY OF THE U.S. ARMY**  
REDSTONE SCIENTIFIC INFORMATION CENTER  
REDSTONE ARSENAL, ALABAMA

# ENGINEERING DESIGN HANDBOOK

## MILITARY PYROTECHNICS SERIES

### PART ONE

## THEORY AND APPLICATION

JAN 15 1968  
2 copies (not ID)  
LIB 2

REDSTONE SCIENTIFIC INFORMATION CENTER  
  
5 0510 00197085 1

HEADQUARTERS  
UNITED STATES ARMY MATERIEL COMMAND  
WASHINGTON, D. C. 20315

AMC PAMPHLET  
No. 706-185

28 April 1967

ENGINEERING DESIGN HANDBOOK  
MILITARY PYROTECHNICS SERIES  
PART ONE--THEORY AND APPLICATION

This pamphlet is published for the information and guidance  
of all concerned.

(AMCRD-R)

FOR THE COMMANDER:

K. H. BAYER  
Major General, USA  
Acting Chief of Staff

OFFICIAL:

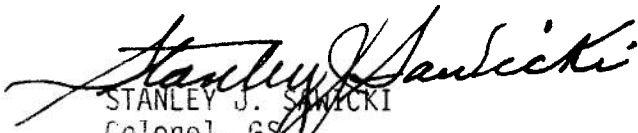
  
STANLEY J. SAWICKI  
Colonel, GS  
Chief, Administrative Office

DISTRIBUTION:  
Special

## PREFACE

The Engineering Design Handbook Series of the Army Materiel Command is a coordinated series of handbooks containing basic information and fundamental data useful in the design and development of Army materiel and systems. The handbooks are authoritative reference books of practical information and quantitative facts helpful in the design and development of Army materiel so that it will meet the tactical and the technical needs of the Armed Forces. The present handbook is one of a series intended to fill a longfelt need for an authoritative and comprehensive source of information on military pyrotechnics.

It is a common misconception to regard military pyrotechnics as being synonymous with fireworks. Military pyrotechnics is rapidly developing into a science which exploits all applicable scientific and engineering principles and practices.

This handbook, *Military Pyrotechnics, Part One, Theory and Application*, includes a chapter on the history of the pyrotechnic art, a chapter giving a general introduction to the application of pyrotechnic devices to military problems, and chapters on Physical-Chemical Relationships, Visibility, Production of Heat, Production of Light, and Production of Smoke.

Material for this handbook, except for Chapter 1, was prepared by the Denver Research Institute of the University of Denver, under the direction of Dr. Robert W. Evans. Material for Chapter 1, History of Military Pyrotechnics, was prepared by the McGraw-Hill Book Company Technical Writing Service. All material was prepared for the Engineering Handbook Office of Duke University, prime contractor to the Army Research Office-Durham. The preparation of this handbook was under the technical guidance of an interservice committee with representation from the Army Chemical Center, Ballistic Research Laboratories, Frankford Arsenal, Harry Diamond Laboratories and Picatinny Arsenal of the Army Materiel Command ; the Naval Ammunition Depot (Crane), Naval Ordnance Laboratory and the Naval Ordnance Test Station. The chairman of this committee was Garry Weingarten of Picatinny Arsenal.

Elements of the U. S. Army Materiel Command having need for handbooks may submit requisitions or official requests directly to Publications and Reproduction Agency, Letterkenny Army Depot, Chambersburg, Pennsylvania 17201. Contractors should submit such requisitions or requests to their contracting officers.

Comments and suggestions on this handbook are welcome and should be addressed to Army Research Office-Durham, Box CM, Duke Station, Durham, North Carolina 27706.

## TABLE OF CONTENTS

<i>Paragraph</i>		<i>Page</i>
	PREFACE .....	i
	LIST OF ILLUSTRATIONS .....	xii
	LIST OF TABLES .....	xvi

### CHAPTER 1

#### HISTORY OF MILITARY PYROTECHNICS

1-1	Introduction .....	1-1
1-2	Early History .....	1-1
1-2.1	Greek Fire .....	1-1
1-2.2	Chinese Pyrotechnics .....	1-2
1-2.3	Gunpowder .....	1-2
1-2.4	Miscellaneous Uses .....	1-2
1-3	18th and 19th Centuries .....	1-2
1-4	Early 20th Century .....	1-3
1-4.1	World War I .....	1-3
1-4.2	Between the Wars .....	1-4
1-4.3	World War II .....	1-4
1-5	Post World War II Period .....	1-5
	REFERENCES .....	1-6

### CHAPTER 2

#### INTRODUCTION TO MILITARY PYROTECHNICS

2-1	Introduction .....	2-1
2-1.1	Pyrotechnic Devices and Uses .....	2-1
2-1.2	Characteristics of Pyrotechnic Compositions .....	2-3
2-1.2.1	Performance Characteristics .....	2-3
2-1.2.2	Processing and Sensitivity Characteristics .....	2-3
2-1.2.3	General Functioning Characteristics .....	2-3
2-1.3	Constituents in Pyrotechnic Compositions .....	2-4
2-1.4	Comparison of Pyrotechnic Mixtures and Explosives .....	2-5
	REFERENCES .....	2-6

## TABLE OF CONTENTS (cont'd)

### CHAPTER 3 PHYSICAL-CHEMICAL RELATIONSHIPS

Paragraph		<i>Page</i>
3-1	State of a System .....	3-1
3-1.1	The Gaseous State .....	3-1
3-1.1.1	Ideal Cases .....	3-1
3-1.1.2	The Universal Gas Constant and Standard Con- ditions .....	3-2
3-1.1.3	Real Gases .....	3-2
3-1.1.4	Gas Mixtures .....	3-3
3-1.1.5	Sample Calculations .....	3-4
3-1.2	The Liquid State .....	3-5
3-1.2.1	Vapor Pressure .....	3-5
3-1.2.2	Boiling Point .....	3-5
3-1.3	The Solid State .....	3-5
3-2	Thermodynamics .....	3-7
3-2.1	Thermodynamic Relationships .....	3-7
3-2.1.1	First Law of Thermodynamics .....	3-7
3-2.1.1.1	Heat Effects at Constant Volume and Constant Pressure .....	3-7
3-2.1.1.2	Heat Capacity .....	3-8
3-2.1.1.2.1	Heat Capacity of Gases .....	3-9
3-2.1.1.2.2	Heat Capacity of Liquids and Solids ....	3-9
3-2.1.2	Second Law of Thermodynamics .....	3-9
3-2.1.3	Third Law of Thermodynamics .....	3-10
3-2.2	Thermochemistry .....	3-11
3-2.2.1	Heats of Reaction .....	3-11
3-2.2.2	Effect of Temperature on the Heat of Reaction	3-12
3-2.2.3	Enthalpy Tables .....	3-13
3-2.2.4	Bond Energies .....	3-13
3-2.3	Free Energy and Equilibrium .....	3-13
3-2.3.1	Chemical Equilibrium .....	3-14
3-2.3.2	The LeChatelier Principle .....	3-16
3-2.3.3	Free Energy and the Equilibrium Constant ....	3-16
3-2.3.4	Free Energy Calculations .....	3-17
3-2.3.5	Tabulated Free Energy Values .....	3-19
3-2.4	Adiabatic Flame Temperature .....	3-19
3-2.5	Sample Thermodynamic Calculations .....	3-20
3-2.6	Summary of Thermochemical Calculations .....	3-23
3-3	Chemical Kinetics .....	3-23
3-3.1	Molecularity of Reactions .....	3-24
3-3.2	Order of Reaction .....	3-25
3-3.3	Influence of Temperature on Reaction Rates .....	3-26
3-3.4	Chain Reactions .....	3-27
3-3.5	Heterogeneous Reactions .....	3-27
3-3.6	Ignition and Propagative Burning .....	3-27

**TABLE OF CONTENTS (cont'd)**

<i>Paragraph</i>		<i>Page</i>
3-3.6.1	Ignition .....	3-28
3-3.6.2	Burning of Metal Particles .....	3-29
3-3.6.3	Burning of Solid Propellants .....	3-29
3-3.6.4	Rate of Propagative Burning .....	3-30
3-4	Thermoanalytical Techniques .....	3-32
	REFERENCES .....	3-36

**CHAPTER 4****VISIBILITY**

4-1	Introduction .....	4-1
4-2	Vision .....	4-1
4-2.1	Brightness Contrast .....	4-1
4-4.2	Overall Contrast .....	4-2
4-3	Attenuation of Contrast .....	4-2
4-3.1	Attenuation of Contrast by the Atmosphere .....	4-3
4-3.2	Obscuration of Vision by Artificial Smoke Clouds .....	4-4
4-4	Visibility of Targets and Signals .....	4-6
4-4.1	Visibility of Targets Under Artificial Illumination ...	4-6
4-4.2	Visibility of Signals .....	4-8
4-4.2.1	Visibility of Smoke Clouds .....	4-9
4-4.2.2	Visibility of Light Sources .....	4-9
4-4.3	Estimation of Visibility .....	4-10
4-4.4	Illustrative Examples .....	4-15
	REFERENCES .....	4-18

**CHAPTER 5****PRODUCTION OF HEAT**

5-1	Historical Summary .....	5-1
5-2	Introduction .....	5-5
5-3	Theory .....	5-5
5-3.1	Amount of Energy Released .....	5-6
5-3.2	Heat Transfer .....	5-7
5-3.2.1	Conduction .....	5-9
5-3.2.2	Convection and Radiation .....	5-10
5-3.3	Heat Effects .....	5-10
5-4	Incendiaries .....	5-11
5-4.1	Small Arms Incendiary Ammunition .....	5-11
5-4.1.1	Ignition and Combustion of Aircraft Fuels .....	5-13

## TABLE OF CONTENTS (cont'd)

Paragraph		<i>Page</i>
5-4.1.2	Nature of a Small Arms Incendiary Burst .....	5-14
5-4.1.3	Small Arms Incendiary Fillers .....	5-16
5-4.1.3.1	Fuels .....	5-17
5-4.1.3.2	Oxidizers .....	5-17
5-4.1.3.3	Binders, Lubricants, and Other Incendiary Mixture Additives .....	5-19
5-4.1.3.4	Typical Compositions .....	5-20
5-4.1.4	Typical Small Arms Incendiary Bullets .....	5-20
5-4.2	Incendiaries for Ground Application .....	5-21
5-4.2.1	Ignition and Combustion of Ground Targets .....	5-21
5-4.2.2	Incendiary Compositions .....	5-22
5-4.2.2.1	Metal-Based Ground Incendiaries .....	5-22
5-4.2.2.2	Liquid Fuel-Based Incendiaries .....	5-24
5-4.2.2.2.1	Liquid Incendiaries .....	5-25
5-4.2.2.2.2	Solidified Liquid Incendiaries .....	5-25
5-4.2.2.2.2.1	Rubber Thickeners .....	5-26
5-4.2.2.2.2.2	Napalm Thickeners .....	5-26
5-4.2.2.2.2.3	Methacrylate Thickeners .....	5-27
5-4.2.2.3	Other Incendiaries .....	5-28
5-4.2.3	Typical Incendiary Devices .....	5-28
5-5	Delay Compositions and Heat Powders .....	5-29
5-5.1	Pyrotechnic Delays .....	5-29
5-5.1.1	Delay Elements .....	5-29
5-5.1.1.1	Obtured Delay Elements .....	5-30
5-5.1.1.2	Vented Delay Elements .....	5-30
5-5.1.2	Delay Compositions .....	5-30
5-5.1.2.1	Black Powder Delays .....	5-31
5-5.1.2.2	Typical Gasless Compositions .....	5-32
5-5.1.3	Factors Affecting Performance .....	5-32
5-5.1.3.1	Composition .....	5-33
5-5.1.3.2	External Pressure .....	5-34
5-5.1.3.3	External Temperature .....	5-35
5-5.1.3.4	Terminal Charge, Anticipatory Effect .....	5-36
5-5.1.3.5	Particle Size .....	5-36
5-5.1.3.6	Ignition Compositions .....	5-37
5-5.1.3.7	Column Diameter .....	5-37
5-5.1.3.8	Loading Pressure .....	5-38
5-5.1.3.9	Housing Material .....	5-39
5-5.1.3.10	Acceleration .....	5-43
5-5.1.3.11	Storage .....	5-43
5-5.2	Heat Powders .....	5-45
5-6	Initiators, First Fires, and Starters .....	5-45
5-6.1	Prime Ignition .....	5-45
5-6.2	Characteristics of Ideal Igniter, First Fire, and Starter Compositions .....	5-46



## TABLE OF CONTENTS (cont'd)

Paragraph		<i>Page</i>
5-6.3	Typical Compositions .....	5-48
	REFERENCES .....	5-48

### CHAPTER 6

#### PRODUCTION OF LIGHT

6-1	Historical Summary .....	6-1
6-1.1	Consolidated Illuminants .....	6-1
6-1.1.1	Flares and Signals .....	6-1
6-1.1.2	Tracers .....	6-2
6-1.2	Nonconsolidated Illuminants .....	6-5
6-1.2.1	Photoflash Devices .....	6-5
6-1.2.1.1	Photoflash Bombs .....	6-5
6-1.2.1.1.1	Composition Type .....	6-5
6-1.2.1.1.2	Dust Type .....	6-6
6-1.2.1.1.3	Segregated Oxidant Type .....	6-7
6-1.2.1.2	Photoflash Cartridges .....	6-7
6-1.2.2	Spotting Charges .....	6-8
6-2	Theory of Light and Color .....	6-8
6-2.1	Behavior of Light .....	6-8
6-2.2	Spectral Distribution .....	6-9
6-2.2.1	Discrete Spectra .....	6-9
6-2.2.1.1	Line Spectra .....	6-9
6-2.2.1.2	Band Spectra .....	6-10
6-2.2.2	Continuous Spectra .....	6-11
6-2.3	Radiation Sources .....	6-11
6-2.3.1	Thermal Radiation Sources .....	6-11
6-2.3.1.1	Blackbody .....	6-11
6-2.3.1.2	Graybody .....	6-12
6-2.3.1.3	Incandescent Sources .....	6-12
6-2.3.2	Luminescence .....	6-13
6-2.3.2.1	Chemiluminescence .....	6-14
6-2.3.2.2	Phosphorescence and Fluorescence .....	6-14
6-2.3.3	Flame Sources .....	6-14
6-2.4	Photometry .....	6-14
6-2.4.1	Instruments for Measuring Light Intensity .....	6-15
6-2.4.2	Measurement of the Light Output of Flares .....	6-15
6-2.4.3	Intensity .....	6-16
6-2.4.4	Brightness .....	6-16
6-2.4.5	Illumination .....	6-16
6-2.4.6	Photometric Units .....	6-16
6-2.5	Color .....	6-17
6-2.5.1	Additive Color .....	6-17

## TABLE OF CONTENTS (cont'd)

<i>Paragraph</i>		<i>Page</i>
6-2.5.2	Subtractive Color .....	6-18
6-2.5.3	Chromaticity Coordinates .....	6-18
6-2.5.4	Munsell Color System .....	6-20
6-2.5.5	Color Value .....	6-20
6-2.6	Atmospheric Effects .....	6-20
6-3	Consolidated Illuminating Devices .....	6-21
6-3.1	Illuminating Flares .....	6-21
6-3.1.1	Aircraft Flares .....	6-21
6-3.1.2	Surface Flares .....	6-23
6-3.2	Illumination Signals .....	6-23
6-3.2.1	Aircraft Illumination Signals .....	6-23
6-3.2.2	Ground Illumination Signals .....	6-24
6-3.3	Tracers .....	6-24
6-3.4	Typical Compositions .....	6-27
6-3.5	Factors Affecting Performance .....	6-27
6-3.5.1	Heat of Reaction .....	6-30
6-3.5.2	Composition .....	6-33
6-3.5.3	Emitters .....	6-33
6-3.5.4	Color Intensifiers .....	6-37
6-3.5.5	Binders .....	6-38
6-3.5.6	Particle Size .....	6-39
6-3.5.7	Consolidation .....	6-41
6-3.5.8	Flare Diameter .....	6-43
6-3.5.9	Case Materials and Coating .....	6-43
6-3.5.10	Temperature and Pressure .....	6-45
6-3.5.11	Rotational Spin .....	6-47
6-3.5.12	Moisture and Stability .....	6-49
6-4	Nonconsolidated Illuminant Charges .....	6-52
6-4.1	Aerial Photographic Illuminants .....	6-53
6-4.1.1	Photoflash Cartridges .....	6-54
6-4.1.2	Photoflash Bombs .....	6-54
6-4.1.3	Other Photographic Illuminant Systems .....	6-54
6-4.2	Spotting Charges .....	6-55
6-4.2.1	Small Arm Spotting Rounds .....	6-55
6-4.2.2	Tracking .....	6-55
6-4.2.3	Indication of Functioning .....	6-56
6-4.3	Typical Compositions .....	6-56
6-4.4	Light Production .....	6-56
6-4.4.1	Light Output Characteristics .....	6-57
6-4.4.1.1	Time Intensity .....	6-57
6-4.4.1.2	Spectral Distribution .....	6-58
6-4.4.2	Nature of the Photoflash Burst .....	6-58
6-4.5	Factors Affecting Performance .....	6-61
6-4.5.1	Charge Weight .....	6-61
6-4.5.2	Composition .....	6-62

**TABLE OF CONTENTS (cont'd)**

Paragraph		<i>Page</i>
6-4.5.3	Particle Size .....	6-64
6-4.5.4	Cloud Shape .....	6-65
6-4.5.5	Bursters and Igniters .....	6-66
6-4.5.6	Confinement .....	6-67
6-4.5.7	Ambient Pressure .....	6-69
	REFERENCES .....	6-70

**CHAPTER 7****PRODUCTION OF SMOKE**

7-1	Historical Summary. General .....	7-1
7-1.1	Screening Smokes .....	7-1
7-1.2	Signal Smokes .....	7-3
7-1.3	Tracking and Acquisition Smokes .....	7-4
7-2	Properties of Smoke .....	7-4
7-2.1	Properties of Particulate Clouds .....	7-5
7-2.1.1	Optical Properties of Particulate Clouds .....	7-7
7-2.1.2	Properties of Particulate Clouds Affecting Their Stability .....	7-7
7-2.1.2.1	Motion of Smoke Particles .....	7-7
7-2.1.2.1.1	Sedimentation .....	7-7
7-2.1.2.1.2	Diffusion .....	7-8
7-2.1.2.2	Evaporation and Condensation .....	7-8
7-2.1.2.3	Coagulation and Agglomeration .....	7-8
7-2.2	Travel and Persistence of Particulate Clouds .....	7-9
7-2.2.1	Meteorological Factors .....	7-9
7-2.2.1.1	Wind Speed and Direction .....	7-9
7-2.2.1.2	Turbulence .....	7-9
7-2.2.1.3	Thermal Gradient .....	7-10
7-2.2.2	Stability of Aerosol Clouds Under Various Meteorological Conditions .....	7-10
7-2.2.2.1	Stable Conditions .....	7-10
7-2.2.2.2	Unstable Conditions .....	7-11
7-2.2.2.3	Estimation of Atmospheric Diffusion .....	7-11
7-2.3	Specific Properties of Military Smokes .....	7-12
7-2.3.1	Screening Smokes .....	7-12
7-2.3.2	Signal Smokes .....	7-13
7-2.3.3	Tracking and Acquisition Smokes .....	7-13
7-2.3.4	Smoke for Dissemination of Agents .....	7-13
7-3	Dissemination Techniques .....	7-14
7-3.1	Formation of the Dispersed Phase .....	7-14
7-3.1.1	Vapor Condensation Processes .....	7-14

## TABLE OF CONTENTS (cont'd)

<i>Paragraph</i>		<i>Page</i>
7-3.1.2	Dispersion Processes .....	7-14
7-3.1.3	Combined Processes .....	7-15
7-3.2	Military Production of Smoke .....	7-16
7-3.3	White Smokes .....	7-16
7-3.3.1	Oil Smoke .....	7-17
7-3.3.1.1	Venturi Thermal Generators .....	7-17
7-3.3.1.1.1	Operation of Venturi Thermal Generators	7-17
7-3.3.1.1.2	Fuel Blocks .....	7-18
7-3.3.1.1.3	Typical Venturi Thermal Generators ....	7-20
7-3.3.1.2	Other Methods for Producing Oil Smoke ....	7-20
7-3.3.2	Phosphorus Smokes .....	7-21
7-3.3.2.1	White Phosphorus .....	7-21
7-3.3.2.2	Burning-Type Mixtures Containing Red Phosphorus .....	7-22
7-3.3.2.3	Metal Phosphides .....	7-22
7-3.3.2.4	Other Reactions for Producing Smokes Containing Phosphorus .....	7-22
7-3.3.2.5	Typical Devices .....	7-23
7-3.3.3	Metal Chloride Smokes .....	7-23
7-3.3.3.1	Liquid Metal Chlorides .....	7-23
7-3.3.3.1.1	FM Smokes .....	7-23
7-3.3.3.1.2	Silicon Tetrachloride .....	7-24
7-3.3.3.1.3	Stannic Chloride .....	7-25
7-3.3.3.2	Solid Metal Chlorides .....	7-25
7-3.3.3.2.1	HC Smokes .....	7-25
7-3.3.3.2.2	Chemistry of HC Smoke Mixtures .....	7-25
7-3.3.3.3	Modified HC Smokes .....	7-27
7-3.3.3.4	Zinc Hexachlorobenzene-Potassium Perchlorate System .....	7-27
7-3.3.3.5	Typical Devices .....	7-28
7-3.3.4	Sulfuric Acid Smokes .....	7-28
7-3.3.4.1	Sulfur Trioxide .....	7-29
7-3.3.4.2	Oleum .....	7-29
7-3.3.4.3	Chlorosulfonic Acid .....	7-29
7-3.3.4.4	Sulfuryl Chloride .....	7-30
7-3.3.4.5	FS Smoke .....	7-30
7-3.3.5	Smoke-Producing Reactions Involving Ammonia or Amines .....	7-30
7-3.3.5.1	Ammonium and Amine Salts of Volatile Acids	7-30
7-3.3.5.2	Metal Chlorides and Ammonia .....	7-30
7-3.3.5.2.1	Hydrogen Chloride and Ammonia .....	7-30
7-3.3.5.2.2	Titanium Tetrachloride and Ammonia ...	7-30
7-3.3.5.2.3	Silicon Tetrachloride, Ammonia, and Water .....	7-31
7-3.3.5.3	Sulfur Compounds and Ammonia .....	7-31

## TABLE OF CONTENTS (cont'd)

<i>Paragraph</i>		<i>Page</i>
7-3.3.5.3.1	Sulfur Trioxide and Ammonia or Amines	7-31
7-3.3.5.3.2	Chlorosulfonic Acid and Ammonia or Amines .....	7-31
7-3.3.5.3.3	Sulfuryl Chloride and Ammonia or Amines	7-31
7-3.3.6	Sulfur Smokes .....	7-31
7-3.3.7	Organic Metallic Compounds .....	7-31
7-3.3.8	Comparison of White Smokes .....	7-32
7-3.4	Colored Smokes .....	7-33
7-3.4.1	Dyes .....	7-33
7-3.4.2	Fuels .....	7-39
7-3.4.3	Oxidants .....	7-39
7-3.4.4	Cooling Agents .....	7-40
7-3.4.5	Binders .....	7-40
7-3.4.6	Evaluation of Colored Smokes .....	7-40
7-3.4.7	Sensitivity of Colored Smoke Mixtures .....	7-40
7-3.4.8	Toxicity of Colored Smoke Mixture .....	7-41
7-3.4.9	Typical Devices .....	7-41
7-3.4.10	Direct Volatilization of Dye .....	7-41
7-3.4.11	Colored Smoke from Solution of Dyes .....	7-43
7-3.4.12	Black Smoke .....	7-44
7-3.4.13	Explosive-Type Colored Smoke Bursts .....	7-45
7-3.4.13.1	Propellant Bursters .....	7-46
7-3.4.13.2	High Explosive Bursters .....	7-46
7-3.4.14	Typical Mixtures .....	7-46
7-3.5	Agent Aerosols .....	7-46
	REFERENCES .....	7-49

## LIST OF ILLUSTRATIONS

<i>Figure No.</i>	<i>Title</i>	<i>Page</i>
3-1	Compressibility Factors as a Function of Reduced Pressure ....	3-3
3-2	Cubic Lattices .....	3-6
3-3	Effect of Temperature on Enthalpy Change for a Chemical Reaction .....	3-12
3-4	Enthalpy of Aluminum Oxide Versus Temperature .....	3-20
3-5	Enthalpy of Products of Magnesium-Air Reaction .....	3-21
3-6	Enthalpy of Products of Magnesium-Sodium Nitrate Flare (Reaction 1) .....	3-23
3-7	Enthalpy of Products of Magnesium-Sodium Nitrate Flare (Reaction 2) .....	3-23
3-8	Enthalpy of IM-11 Incendiary Mixture .....	3-26
3-9	The Relationship Between Heat of Reaction and Heat of Activation .....	3-26
3-10	Ignition Time-Temperature Plots for a Binary Pyrotechnic Mixture .....	3-28
3-11	Model for Burning of Aluminum Particles .....	3-29
3-12	Model for Steady State Progressive Burning .....	3-30
3-13	Differential Thermal Analysis Thermocouple Circuit .....	3-31
3-14.1	Thermogravimetric Curve for the Ingredient Sodium Nitrate ....	3-32
3-14.2	Thermogravimetric Curve for the Ingredient Magnesium .....	3-32
3-14.3	Thermogravimetric Curve for the Ingredient Laminac 4116 .....	3-32
3-15.1	Differential Thermal Analysis Curve for the Ingredient Sodium Nitrate .....	3-33
3-15.2	Differential Thermal Analysis Curve for the Ingredient Magnesium	3-33
3-15.3	Differential Thermal Analysis Curve for the Ingredient Laminac 4116 .....	3-33
3-16.1	Differential Thermal Analysis Curve for the Magnesium-Sodium Nitrate Mixture (Curve I) .....	3-34
3-16.2	Differential Thermal Analysis Curve for the Sodium Nitrate- Carbon Mixture .....	3-34
3-16.3	Differential Thermal Analysis Curve for the Magnesium-Sodium Nitrate Mixture (Curve II) .....	3-34
3-16.4	Differential Thermal Analysis Curve for the Sodium Nitrate- Laminac Mixture .....	3-34
3-16.5	Differential Thermal Analysis Curve for the Magnesium-Laminac Mixture .....	3-35
3-17.1	Differential Thermal Analysis Curve for the Magnesium-Sodium Nitrate-Carbon Composition .....	3-35
3-17.2	Differential Thermal Analysis Curve for the Magnesium-Sodium Nitrate-Laminac Composition .....	3-35

## LIST OF ILLUSTRATIONS (cont'd)

<i>Figure No.</i>	<i>Title</i>	<i>Page</i>
4-1	Thresholds of Brightness-Contrast for 80% Detection for Five Angular Fields (Minutes of Arc) .....	4-2
4-2	Apparent Contrast as a Function of Distance .....	4-2
4-3	Optical Slant Range Diagram for the Optical Standard Atmosphere	4-5
4-4	Brightness Requirements as a Function of Acuity and Contrast	4-6
4-5	Effect of Direction of Illumination on the Luminance of a Smoke Column .....	4-9
4-6	Effect of Relative Direction of Sun and Smoke on Time of Discovery .....	4-9
4-7	Visibility Nomograph .....	4-12
4-8	Visibility Nomograph for Signal Lights .....	4-14
4-9	Visibility Nomograph Showing Calculation .....	4-16
4-10	Visibility Nomograph for Signal Lights Showing Calculation ....	4-17
5-1	Constant Ignition Probability Regions About a Fuel Jet of Gasoline or Kerosene .....	5-14
5-2	Maximum Temperature, $T$ , as a Function of Heat of Reaction and Average Specific Heat, $C$ .....	5-16
5-3	Cooling Time to 800°K as a Function of Temperature and Heat Capacity, $C$ .....	5-16
5-4	Cooling Time to 800°K as a Function of Heat of Reaction and Specific Heat, $C$ .....	5-17
5-5	Time-Temperature Histories for IM-11, <b>IM.23.</b> and IM-103 .....	5-18
5-6	Cooling Curves for Mixtures Containing Various Particle Sizes and Shapes of Magnesium-Aluminum 50/50 Alloy .....	5-19
5-7	Typical Caliber .50 Incendiary Bullet .....	5-21
5-8	Typical Caliber .50 Armor-Piercing Incendiary Bullet .....	5-22
5-9	Typical 20 mm Armor-Piercing Incendiary Bullet .....	5-23
5-10	Typical 20 mm High Explosive Incendiary Projectile .....	5-24
5-11	Four-Pound Magnesium Alloy Incendiary Bomb .....	5-29
5-12	Four-Pound Thermite Incendiary Bomb .....	5-30
5-13	Typical Napalm Bomb .....	5-31
5-14	Typical Incendiary Grenade .....	5-32
5-15	Obturated Delay Element .....	5-32
5-16	Sealing of Vented Delay Element .....	5-33
5-17	Time Delay Ring or Train, Vented .....	5-38
5-18	Total Heat Evolved Versus Burning Time of Binary Barium Chromate-Boron Compositions Loaded to a Height of 0.79 Inch in M112 Fuze Housing at 36,000 psi .....	5-38
5-19	Burning Time of M112 Fuze Versus External Pressure .....	5-39
5-20	Burning Time of M112 Fuze Containing 90% Barium Chromate-10% Boron Composition Versus Logarithm of Absolute Temperature .....	5-43
6-1	Emission Spectrum and Energy Levels of Hydrogen Atom .....	6-10
6-2	Various Types of Spectra and Corresponding Electronic, Vibrational and Rotational Motion .....	6-11

## LIST OF ILLUSTRATIONS (cont'd)

<i>Figure No.</i>	<i>Title</i>	<i>Page</i>
6-3	Planck's Law : Radiance as a Function of Wavelength for Various Temperatures .....	6-12
6-4	Radiant Energy in Different Wavelength Bands as a Function of Temperature .....	6-12
6-5	Isothermal Efficiencies: Fraction of Energy Emitted by an Isothermal Radiator in Various Wavelength Bands as a Function of Temperature .....	6-13
6-6	„Optical” Temperatures of a Tungsten Filament .....	6-13
6-7	Dimensions of the Psychological Color Solid .....	6-18
6-8	Additive Mixture of Primary Colors .....	6-18
6-9	Tristimulus Values of the Spectrum Colors According to the 1931 I.C.I. Standard Observer .....	6-19
6-10	C.I.E. Chromaticity Diagram .....	6-19
6-11	Illumination Diagram for Parachute Suspended Flare .....	6-23
6-12	Intensity Curves for Various Parachute Flare Heights .....	6-24
6-13	Typical Aircraft Parachute Flare .....	6-25
6-14	Operation of Typical Aircraft Parachute Flare .....	6-26
6-15	Typical Aircraft Tow Target Flare .....	6-27
6-16	Typical Surface Trip Flare .....	6-31
6-17	Typical Hand-Held Illuminating Signal .....	6-32
6-18	Small Arms Tracer .....	6-32
6-19	Armor-Piercing Tracer .....	6-33
6-20	Artillery Tracer Element in Projectile .....	6-34
6-21	Artillery Tracer .....	6-35
6-22	Zones in Flame Propagation .....	6-39
6-23	Temperature Distribution in a Pyrotechnic Flame .....	6-40
6-24	Luminous Intensity as a Function of Magnesium Content of Binary Mixtures Containing Various Oxidizing Agents .....	6-41
6-25	Burning Rate as a Function of Magnesium Content of Binary Mixtures Containing Various Oxidizing Agents .....	6-42
6-26	Chromaticity Data for Red, Yellow, and Green Flares .....	6-44
6-27	Typical Spectra of Signal Flares .....	6-45
6-28	Spectral Energy Distribution of Green Flare .....	6-48
6-29	Magnesium Content Versus Excitation Purity for a Yellow Flare .....	6-49
6-30	Effect of Polyvinylchloride on the Candlepower of Mixtures Containing Strontium Nitrate and Ground Magnesium, Grade A .....	6-49
6-31	Effect of Polyvinylchloride on the Color Value of Mixtures Containing Strontium Nitrate and Ground Magnesium, Grade A .....	6-50
6-32.1	Burning Rate vs Particle Size of Magnesium .....	6-52
6-32.2	Candlepower vs Particle Size of Magnesium .....	6-52
6-33	Effect of Loading Pressure on Burning Rate of Pyrotechnic Compositions .....	6-53
6-34	Effect of Spin Upon Trace Duration of Various Standard Tracer Compositions When Loaded into Caliber .50 M1 Jacket .....	6-53
6-35	Diagram of Bomb Burst and Trail Angle .....	6-54
6-36	Typical Characteristics of Black and White Negative Material ...	6-56



## LIST OF ILLUSTRATIONS (cont'd)

<i>Figure No.</i>	<i>Title</i>	<i>Page</i>
6-37	Typical Photoflash Cartridge .....	6-58
6-38	Typical Photoflash Bomb .....	6-61
6-39	Typical 20 mm Spotting Round .....	6-63
6-40	Photoflash "Daisy" Cartridge .....	6-63
6-41	Typical Flash Charge for "Indication of Functioning" .....	6-65
6-42	Typical Time-Intensity Curve .....	6-66
6-43	Synchronization of Shutter .....	6-67
6-44	Time-Intensity Curves for M120A1 Flash Powder and M122 Dust Photoflash Bombs .....	6-67
6-45	Spectral Energy Distribution Curve of M120 Photoflash Bomb ...	6-68
6-46	Effect of Particle Size of Potassium Perchlorate on Luminous Efficiency of 60/40 Potassium Perchlorate-Aluminum Compositions .....	6-68
6-47	Size and Light Output of Flash Cloud vs Time .....	6-68
7-1	Approximate Size Range of Airborne Particles .....	7-5
7-2	Scattering by Spherical Particles With Indicated Refractive Indexes .....	7-6
7-3	Typical Venturi Thermal Generator .....	7-18
7-4	Typical Oil Smoke Pot (Floating) .....	7-20
7-5	Typical Oil Smoke Pot (Training) .....	7-20
7-6	Typical WP-Filled Device (M15 WP Smoke Hand Grenade) ....	7-22
7-7	Typical Red Phosphorus-Filled Device .....	7-23
7-8	AN-M8 HC Smoke Hand Grenade .....	7-28
7-9	M5 HC Floating Smoke Pot .....	7-28
7-10	Differential Thermal Analysis and Thermogravimetric Analysis Curve for 1,8-dihydroxyanthraquinone .....	7-36
7-11	Differential Thermal Analysis and Thermogravimetric Analysis Curve for 1,4-di-p-toluidinoanthraquinone .....	7-36
7-12	105 mm M84 Colored Smoke Projectile .....	7-41
7-13	M18 Colored Smoke Hand Grenade .....	7-43
7-14	4.2-in. Colored Marker Projectile, Colored Smoke, E75 .....	7-44
7-15	105 mm M1 Colored Marker Projectile .....	7-45

## LIST OF TABLES

<i>Table No.</i>	<i>Title</i>	<i>Page</i>
2-1	Tabulation of Pyrotechnic Devices .....	2-2
2-2	Comparison of Some Properties of Pyrotechnic Compositions With Explosives .....	2-5
3-1	Criteria of Spontaneity .....	3-11
3-2	Thermodynamic Properties of Solid Magnesium Oxide .....	3-14
3-3	Thermodynamic Properties of Solid Aluminum Oxide .....	3-15
3-4	Thermodynamic Properties of Solid Sodium Oxide .....	3-16
3-5	Thermodynamic Properties of Liquid Sodium Oxide .....	3-17
3-6	Thermodynamic Properties of Oxygen .....	3-18
3-7	Example of Thermochemical Calculations : Lanthanum- Potassium Perchlorate Reaction .....	3-24
3-8	Example of Thermochemical Calculations : Zirconium-Oxygen Reaction .....	3-25
4-1	Meteorological Range for Typical Weather Conditions .....	4-4
4-2	Reflectance Values (in percent) of Various Terrain Features and Building Materials .....	4-7
4-3	Maximum Angular Size of Light Source as a Function of Adaptation Brightness .....	4-10
4-4	Visibility of Flashing Light Compared to Steady Light .....	4-11
4-5	Absorption of Sunlight by Atmosphere .....	4-11
4-6	Sky Brightness .....	4-13
4-7	Sky-Ground Ratio .....	4-13
4-8	Increase in Illumination Required for Positive Recognition .....	4-15
5-1	Heats Evolved from Reactions of Aluminum and Various Oxidizing Agents .....	5-6
5-2	Oxygen Content of Various Nitrates .....	5-7
5-3	Oxygen Content of Various Perchlorates .....	5-8
5-4	Oxygen Content of Various Oxides and Peroxides .....	5-8
5-5	Heat of Reaction of Reducing Agents With Barium Peroxide .....	5-9
5-6	Summary of Limits of Flammability of Various Gases and Vapors in Air and in Oxygen .....	5-12
5-7	Typical Small Arms Incendiary Mixtures .....	5-20
5-8	Heat of Reaction of Thermite-Type Mixtures Containing Magnesium .....	5-25
5-9	Modified Thermite Compositions .....	5-25
5-10	Heats of Combustion and Hydrogen-Carbon Ratios of Selected Fuels .....	5-26
5-11	Composition of IM-Type Incendiary Gels .....	5-27
5-12	Composition of PT Incendiary Mixtures .....	5-28
5-13	Gasless Delay Compositions in Current Use .....	5-34

## LIST OF TABLES (cont'd)

<i>Table No.</i>	<i>Title</i>	<i>Page</i>
5-14	Burning Rates of Gasless Delay Compositions .....	5-35
5-15	Heats of Reaction of Inorganic Mixtures Considered for Delays ..	5-36
5-16	Effect of Percent Composition on Burning Time, Heat of Reaction, and Impact Values of the Barium Chromate-Boron System .....	5-37
5-17	Extent of Anticipatory Effect as a Function of Burning Rate of Various Barium Chromate-Boron Compositions .....	5-38
5-18	Extent of Anticipatory Effect as a Function of Column Length of 55/35/10 Tungsten-Barium Chromate-Potassium Chromate Composition .....	5-39
5-19	Effect of Specific Surface on Burning Time of Tungsten Delay Compositions .....	5-40
5-20	Ignition Powders for Gasless Delay Elements .....	5-40
5-21	Effect of Fuze Housing Material and Dimensions on Burning Time of Barium Chromate-Boron Compositions .....	5-41
5-22	Effect of Loading Pressure on Barium Chromate-Boron Compositions .....	5-42
5-23	Effect of Storage on Fuzes Loaded With Barium Chromate-Boron Compositions .....	5-44
5-24	Burning Times of Fuzes Loaded With 93/7 Barium Chromate- Boron Compositions Stored Loose Under Various Conditions ...	5-44.
5-25	Commercial Safety Match Composition .....	5-46
5-26	Safety Match Striker Composition .....	5-47
5-27	SAW ("Strike-Anywhere") Match Composition .....	5-47
5-28	Friction Primer Compositions .....	5-48
5-29	Some First Fire, Starter, and Igniter Compositions .....	5-49
6-1	Conversion Factors for Photometric Units .....	6-17
6-2	Candlepower Requirements Versus Height of Illuminating Source	6-21
6-3	Characteristics of Various Illuminating Flares .....	6-22
6-4(A)	Characteristics of Various Aircraft Signal Flares .....	6-28
6-4(B)	Characteristics of Various Ground Signal Flares .....	6-30
6-5	Typical Illuminating, Signaling, and Tracer Compositions .....	6-36
6-6	Heats of Reaction of Aluminum With Stoichiometric Quantities of Various Oxidants .....	6-37
6-7	Heats of Reaction of Magnesium With Stoichiometric Quantities of Various Oxidants .....	6-38
6-8(A)	Physical Data and Burning Characteristics for Stoichiometric Mixtures of Various Oxidants With Atomized Magnesium .....	6-43
6-8(B)	Characteristics of Binary Mixtures Containing Oxidizing Agents and Atomized Magnesium, Grade A .....	6-46
6-9	Characteristics of Pyrotechnic Compositions Containing Various Polyester Resin Binders .....	6-47
6-10	Effect of Particle Size on Burning Rate and Candlepower for Magnesium-Sodium Nitrate-Polyvinylchloride-Laminae Mixture	6-49
6-11	Effects of Change in Specific Surface of Magnesium Particles ...	6-50

## LIST OF TABLES (cont'd)

<i>Table No.</i>	<i>Title</i>	<i>Page</i>
6-12	Effect of Loading Pressure on Burning Characteristics of Magnesium-Sodium Nitrate Flares .....	6-50
6-13	Effect of Simulated Altitude and Temperature on Illumination Characteristics of Yellow Signals .....	6-51
6-14	Effect of Simulated Altitude and Temperature on Illumination Characteristics of Red Signals .....	6-51
6-15	Effect of Simulated Altitude and Temperature on Illumination Characteristics of Green Signals .....	6-52
6-16	Designation and Description of Photoflash Cartridges .....	6-55
6-17	Characteristics of Type III Photoflash Composition .....	6-57
6-18	Designations and Descriptions of Flash Powder Photoflash Bombs .....	6-59
6-19	Characteristics of Dust Photoflash Bombs .....	6-60
6-20	Segregated Oxidant Photoflash Bombs .....	6-61
6-21	Typical Compositions for Photoflash and Spotting Charges .....	6-62
6-22	Luminosity Characteristics at Sea Level of Photoflash Compositions Consisting of High-Energy Fuels in Stoichiometric and Fuel-Rich Combinations With Potassium Perchlorate ....	6-64
6-23	Thermodynamic Data for Stoichiometric Mixtures of Oxidizing Agents and Atomized Aluminum .....	6-65
6-24	Luminosity Values of Various Oxidants With Atomized Aluminum and Atomized Magnesium Tested in M112 Photoflash Cartridge .....	6-66
6-25	High Explosives Tried As Bursters in Flash Bombs .....	6-68
6-26	Luminosity Characteristics of Photoflash Compositions Consisting of High-Energy Fuels in Stoichiometric Combination With Potassium Perchlorate .....	6-69
7-1	Terminal Velocities and Diffusion Coefficients of Rigid Spheres of Unit Density in Air at 760 mm Hg Pressure and 20°C .....	7-a
7-2	Characteristics of Typical Oil Smoke Pots .....	7-19
7-3	Characteristics of Typical Devices Using Phosphorus Filling ....	7-24
7-4	Variation of Burning Time of Type-C HC Smoke Mixture With Aluminum Content .....	7-26
7-5	Characteristics of Typical Devices Using HC Mixture .....	7-29
7-6	Total Obscuring Power of White Smokes .....	7-32
7-7	Amount of Smoke Agents Required To Produce 1.000 Cubic Feet of Standard Smoke .....	7-32
7-8	Amount of Smoke Produced Per Unit Weight of Smoke Agent at 75% Relative Humidity .....	7-33
7-9	Some Dyes Which Have Been Used in Burning-Type Colored Smoke Munitions .....	7-34
7-10	Some Dyes Which Have Been Used in Explosive-Type Colored Smoke Munitions .....	7-35
7-11	Characteristics of Typical Ejection-Type Colored Smoke Devices .....	7-42
7-12	Basic Differences Between the Colored Marker and Base-Ejection Smoke Projectiles for 105 mm Gun .....	7-45
7-13	Typical Smoke Compositions .....	7-47

## CHAPTER 1

## HISTORY OF MILITARY PYROTECHNICS

## 1-1 INTRODUCTION

Pyrotechnics is an old craft that has continued to assume greater military importance. In their simplest form, pyrotechnic devices consist of an oxidizing agent and a fuel that produce an exothermic self-sustaining reaction when heated to ignition temperature. Man's earliest pyrotechnic devices may have been the result of an accidental mixing of saltpeter ( $\text{KNO}_3$ ) with charcoal; or natural tars and resins, animal fats, volcanic dusts, salts, sulfur, or other flammable materials.

In modern warfare, some of the important uses for pyrotechnic devices are: as incendiaries; as luminous sources for missile tracking; as accessories in aircraft, missiles, and nuclear devices; to produce sound signals; and to produce visible luminous and smoke signals. Illuminating devices are also used for photography.<sup>4</sup> Recent adaptations include devices designed for actuation by radio signals directed to a missile thousands of miles from earth.

1-2 EARLY HISTORY<sup>1,2,3,5,6,7</sup>

Incendiary and colored smoke mixtures were used for war, religious celebrations, and entertainment in Arabia, China, Egypt, Greece, and India in very ancient times. As early as 2000 B.C., tales of war in India mention incendiaries, smoke screens, and noxious fumes. Later, against Alexander the Great (365-323 B.C.), defenders of an Indian city were reported able to "shoot thunder and lightning from the walls." To this day, natural deposits of saltpeter are abundant in India, and probably served as a source of this material for employment in the compositions making these displays possible.

Knowledge of pyrotechnics traveled from the East to Europe at the beginning of the Christian era. The earliest record of pyrotechnic exhibitions

in Europe mentions the Roman Circus during the reign of Augustus (27 B.C. to 14 A.D.). Roman use of pyrotechnics appears to have been largely for display. Movable frameworks were fitted with adjustable parts and designed to set in motion various colored lights.

A military use of pyrotechnics that began early and persisted for many centuries was the use of fire ships in marine warfare. The earliest recorded mention of fire ships is from the 4th century B.C. when the Phoenician seamen of Tyra used them in battle against Alexander the Great. Later records show that the Greeks used them against the Turks, the Crusaders used them at Acre, and the English, in the 16th century, used them with success against the Spanish Armada.

## 1-2.1 GREEK FIRE

One of the earliest and most successful means of chemical warfare was the mixture known as Greek fire, the use of which is first reported in the 7th century, A.D. This mixture of sulfur, resin, camphor, and other unknown combustible substances, melted with saltpeter, was a powerful incendiary that also produced suffocating fumes. It was used in many different ways. Sometimes woolen cords were soaked in the mixture, dried, and rolled into balls. The balls were then lighted and hurled by large engines at enemy ships or tents. Defenders of cities prepared it in liquid form; poured it into jars; then ignited the mixture and poured it upon those besieging the city walls. In open battles, it was squirted by hand pumps and bellows through pipes into enemy ranks, or against wooden barricades. In 901 A.D. the Saracens were reported to have blown it from pipes mounted on the decks of their ships. Five centuries later, in Emperor Leo's attack on Constantinople in 1453 A.D., 2000 enemy ships were reported destroyed by its use.

### 1-2.2 CHINESE PYROTECHNICS

Records of Chinese pyrotechnic items go back to the 10th century. Rockets and Roman candles are mentioned in 969 A.D. and, by the 13th century, colored smokes for signaling, incendiary-carrying fire arrows, and rocket-propelled arrows were employed. The rocket-propelled arrows, fired in clusters from metal containers, were sometimes fitted with poisoned razor-sharp heads for attacks from ambush and the defense of defiles. Other Chinese weapons of this time included "flying fire spears" equipped with tubes that threw fire forward for about 30 feet. Pyrotechnic devices were also used in defending cities—the Kin Tartars are known to have used fire powders and other pyrotechnic devices against a Mongol attack in 1232 A.D.

### 1-2.3 GUNPOWDER

The inventor of gunpowder is generally believed to have been the English philosopher, Friar Roger Bacon. In 1242 A.D. he revealed the ingredients for black powder in defending himself against an accusation of witchcraft. Although Bacon knew of the explosive power of gunpowder, he apparently did not recognize the possibility of using it for projection of missiles.

The earliest recorded use of firearms or of gunpowder as a propellant is in the beginning of the 14th century. Records of the University of Ghent in Belgium indicate that the first gun was invented by Berthold Schwarz in 1313, and commercial records indicate that guns and powder were exported from Ghent to England in the following year. Guns and gunpowder may have been used in the English invasion of Scotland in 1327, but the earliest undisputed record of the use of gunpowder in war is in France at the battle of Crecy in 1346. Gunpowder was also used as an explosive to blast fortification walls, the first reported attempts being at Pisa in 1403, and in land mines, which were described in 1405.

When gunpowder began to be used as a propellant in the 14th to 15th century, the usefulness of the incendiaries then available declined. Because of the use of gunpowder, armies began to engage each other at such distances as to prohibit

the use of contact or short range incendiary devices.

### 1-2.4 MISCELLANEOUS USES

The first recorded use of screening smoke in more recent times occurred in 1701, when Charles XII of Sweden burned damp straw to produce a smoke screen to cover a river crossing. Elsewhere in Europe at this time pyrotechnic devices were being developed for their military value. The French kings encouraged experiments and tests, saw that proper records were kept, of which many are still available, and collected information from travelers returning from other countries. French priests returning from China brought detailed knowledge of the state of the art in that country.<sup>9</sup>

### 1-3 18TH AND 19TH CENTURIES<sup>2,3,5,6</sup>

Berthollet's discovery of potassium chlorate in 1788 began the modern era in pyrotechnics. Potassium chlorate made color effects in pyrotechnic flames possible and the introduction of magnesium in 1865 and aluminum in 1894 added greatly to the variety of effects attainable.

In Europe there was also a great interest in the use of rockets. Several types were developed, the most successful being the Congreve rocket, which was 30 inches long, 3½ inches in diameter, and carried an incendiary charge. The British used rockets with pyrotechnic compositions in a number of campaigns. A rocket corps was part of the British Army during the Revolutionary War, and again during the War of 1812. The 1805 expedition of Sir Sidney Smith against Boulogne included boats fitted for salvo firing of rockets, and rockets were used successfully in the British attack on Copenhagen and by Wellington's army.

In the United States at this time, a number of pyrotechnic devices were items of general ammunition issue. An 1849 Ordnance manual describes signals, lights, torches, tarred links, pitched fascines, incendiary matches, and other illumination devices. The manual also lists firestone, Valenciennes composition, and fireballs—incendiaries, when projected from mortars, designed to set fire to enemy property. Besides the Congreve rocket, which came in 2¼- and 3¼-inch sizes. The

2¼-inch rocket had a maximum range of 1760 yards and the 3¼-inch rocket had a somewhat greater range. The rockets were made of sheet or cast iron and fired from tubes mounted on portable stands or light carriages. An 1861 Ordnance manual lists most of the 1849 devices with more detail and some improvements. Two new items were also listed: an incendiary projectile filling called rockfire, which burned slowly and was hard to extinguish. It was employed to set fire to buildings, ships, and flammable stores. Another new device was the petard, a powder-filled wooden box that was used to demolish doors, gates, barriers, and other obstacles.

A number of gunpowder improvements were made in the United States and Europe during the latter half of the 19th century. After General Thomas J. Rodman, U.S. Army, discovered the principle of the progressive burning of propellant powder in 1860, powder grains were made in sizes adapted to the caliber of gun, with larger and perforated grains used in larger weapons. The Swedish inventor, Nobel, made many of his important discoveries at this time. In 1863 he first manufactured nitroglycerin commercially, and during the next twenty years invented dynamite, the fulminate blasting cap, blasting gelatin, gelatin dynamite, and ballistite. Another improvement came in 1886 when Vieille, a French chemist, discovered the means to colloid nitrocellulose and thus control the grain size of the propellant powder.

#### 1-4 EARLY 20TH CENTURY<sup>2,3,5,6,7,8,9,10</sup>

An important pyrotechnic development early in this century was the tracer bullet. Tracers have been used in all types of projectiles, but their development has been most closely connected with ammunition for automatic small arms. Tracers were the best devices for directing automatic small arms fire against fast moving ground targets. In this country, research and development of small arms tracers was carried out at Frankford Arsenal. The U. S. Navy and Picatinny Arsenal also conducted tracer development for 20 mm, 40 mm, and larger guns.

The German Navy conducted fleet maneuvers using chemically produced screening smoke for the first time in 1906, and later used such smoke

screens with success at the Battle of Jutland in 1916. As a result of this success, the Allies and the Germans developed pyrotechnic screening smoke for use on both land and sea during World War I.

#### 1-4.1 WORLD WAR I

During World War I, opposing troops in trenches separated by short distances regularly employed pyrotechnic devices. Illuminating projectiles were used as protection against surprise attack, and signals were used to request, adjust, or stop artillery fire; to mark enemy and friendly troop locations; and for emergencies on land, sea, and in the air.

The advent of the airplane overcame the difficulties of using incendiaries against distant armies. Forerunners of today's incendiary bombs were first dropped on London in May 1915 from German Zeppelins, and a prototype of the portable flamethrower was used by the Germans against the French in April and June of that year, although with little success. Later in the war, bombs containing white phosphorus, thermite, and thickened liquid fuels were dropped from airplanes.

Before and during World War I most pyrotechnic development and manufacturing in the United States was carried out by private contractors to the Army or Navy. The Star rifle light, the Very pistol, position lights, and simple rockets were the main items used. As the war continued, the armed services began to test and develop pyrotechnic devices for special purposes.

The use of chemical agents during the war resulted in the establishment of a Chemical Warfare Service in 1918. This organization became a permanent branch of the U.S. Army in 1920, and in 1946 its name was changed to the U.S. Army Chemical Corps. This technical service pursued the development of incendiaries, screening and signaling smokes, flame throwers, and toxic chemical compounds.

Aberdeen Proving Ground in Maryland was activated in October 1917, and by December of that year was making acceptance tests of ammunition and other Ordnance materiel. Aberdeen records for 1918 list tests of illuminating parachute projectiles for the 155mm gun.

Frankford Arsenal, during the early days of

the war, adapted foreign pyrotechnic compositions to small arms ammunition. Later, it developed tracer and igniter compositions and started a well-integrated program for standardization. These early tracer compositions were made by a small batch process, wet mixed, dried, and ground to produce a stable, uniform composition. These early compositions were only moderately satisfactory in that the calomel used as a flame brightener produced season cracking in brass, and also limited the life of the composition.

During the war the Navy developed and used 3-, 4-, 5-, and 6-inch illuminating projectiles with a projection range up to 7 miles, a major advantage because the Star rifle light was projected to a maximum range of only 800 yards. The Navy also developed water markers for use from submarines, as well as for dropping from aircraft. These markers consisted of surface burning smoke and flame-producing items, colored aerial stars, and surface marking dyes.

#### 1-4.2 BETWEEN THE WARS

During the period between World War I and World War II, arsenals, such as Picatinny and Frankford, and the Army Chemical Corps carried on limited research on military applications of pyrotechnics. Some universities also assisted in this work.

Picatinny Arsenal, which had been established by the Ordnance Corps in 1879 as a small powder depot to manufacture and load munitions, began loading propellant charges in 1896, projectiles in 1902, and propellant manufacture in 1907. In 1919, it began to develop and manufacture pyrotechnic signals, and continued the pyrotechnic research and development effort in the period between the wars. During this time, it made considerable progress in developing new smoke, flare, tracer, and delay compositions, and began to accumulate evidence regarding the necessity for purer ingredients, more careful control of particle size, and improved processing methods. Other investigations produced techniques to measure luminosity and color of pyrotechnic flames, technical requirements for specifying ingredients, and recognition of the importance of avoiding moisture in pyrotechnic compositions. Although there had

been little scientific testing of pyrotechnic devices, the body of data that existed at Picatinny Arsenal at the outbreak of WW II was of considerable value in developing improved pyrotechnic items needed for the highly mobile forces of that war.

Aberdeen Proving Ground added development testing to its proof testing in the 1920's. In 1921 development tests were reported on green, yellow, and white smokes, and two years later tests of long burning white parachute signals were conducted.

About 1933, Frankford Arsenal refined the process of making tracer compositions so that only the calcium resinate and the hygroscopic strontium peroxide were wet mixed. Since then, streamlining of the process has continued and now all ingredients in the tracer mix are purchased in the required granulation, blended dry, and charged into bullet cavities under high pressures. In 1936 Frankford began developing delay action and dim igniters, some of which are now standard compositions. Just before the United States entered World War II, Frankford greatly improved incendiary mixture IM-11. This standard incendiary mixture, which was originally developed by Picatinny Arsenal, was quickly adopted by the British and was used by American forces in all small arms incendiary bullets during World War II.

The Navy pyrotechnic development between the wars was centered at the U.S. Navy Yard in Washington, D. C. Production was carried out at the Naval Ordnance Plant at Baldwin, New York. For a time its one product was illuminating projectiles, but in 1930 production of aircraft parachute flares was also added. Also, by 1933 the Experimental Ammunition Unit of the Naval Gun Factory had developed a number of pyrotechnic items including emergency identification signals, aircraft signal cartridges, and ammunition tracers.

#### 1-4.3 WORLD WAR II

In 1940, and later with the entry of the United States into World War II, pyrotechnic items such as flares, illuminating projectiles, smoke signals, spotting charges, many types of ground and aircraft signals, and incendiaries were needed in enormous quantities.

Flares were widely used to illuminate landing



fields at night, in rain, and in fog. They were dropped from aircraft to illuminate enemy territory; to silhouette ships for observation; and to locate targets for bombing. Photoflash bombs illuminated large areas for night photography.

Smoke screens were used by land and sea forces for a variety of purposes: aircraft and smoke boats screened ships during air attacks and amphibious landings, concealed underwater demolition teams and tactical maneuvers of ground troops.

By the end of the war pyrotechnics provided visual communication both day and night between planes and tanks, tanks and artillery, infantry and aircraft, and ships and the shore.

Incendiary bullets, bombs, projectiles, and grenades were widely used in Europe. Allied tactics in bombing German cities employed equal quantities of incendiaries and high explosives. On a weight basis, the incendiary bombs caused five times more damage than high explosive bombs. The central parts of more than 50 of Germany's largest cities were leveled by fire. Before nuclear weapons were used fifty percent of 70 Japanese cities had been burned. More than 99 percent of the total bomb load dropped on Japanese cities was incendiary, with less than 1 percent high explosive. During the war, hundreds of millions of incendiary bombs, projectiles, and grenades were provided by the Chemical Warfare Service—over 48 million incendiary bombs alone were supplied to the U.S. Army Air Force.

Flame throwers, which had been developed during World War I, were improved and used with success in the campaigns in the Pacific areas during World War II.

Picatinny Arsenal developed many improved pyrotechnic items to meet the military change from trench warfare, which had existed in World War I, to the highly specialized mobile forces of World War II. Pyrotechnic ammunition for military maneuvers and means for providing visual communication among the various elements involved were essential. More efficient flares, flash charges, and a variety of spotting charges, signals,

tracers, and troop warning devices were developed to meet the new tactical requirements. New ingredients such as atomized magnesium, resins, color intensifiers, and others were tested and adopted; improved techniques to measure luminosity and color, such as the barrier-layer cell photometer, were introduced.

The Ballistic Research Laboratories had been established in 1938 to centralize research activities at Aberdeen Proving Ground and to undertake research in fundamental Ordnance problems. With completion of a new laboratory in 1941, basic studies were begun in areas pertinent to pyrotechnics such as flame propagation, burning rates, sensitivity of pyrotechnic compounds, and the physical chemistry of gases.

Naval pyrotechnics development during World War II was centered at the Naval Ordnance Laboratory, then located at the Naval Gun Factory, Washington, D. C., and production was centered at the Naval Ammunition Depot, Crane, Indiana. The Navy improved existing items for greater reliability and storage characteristics, and developed such items as chemical delay powders, self-releasing buoyant submarine signals, rescue flares, depth charge markers, aircraft signal cartridges, and parachute flares.

#### 1-5 POST WORLD WAR II PERIOD<sup>4,12</sup>

Funds for research and development of pyrotechnic items were limited in the period following World War II; however, significant advances were accomplished which made available improved pyrotechnic devices, signals, smokes, incendiaries, and battlefield illuminants when the Korean Conflict developed in the early 1950's.

Most pyrotechnic research and development today is carried out by the Government at Picatinny Arsenal, Aberdeen Proving Ground, Frankford Arsenal, the Army Chemical R&D Laboratories, the Naval Ordnance Laboratory, the Naval Ordnance Test Station, the Naval Ammunition Depot, and by Government-sponsored agencies.

## REFERENCES

1. a. T. L. Davis, "Early Pyrotechnics. I. Fire for the Wars of China; 11. Evolution of the Gun; 111. Chemical Warfare in Ancient China," *Ordnance* **33**, 52, 180, 396 (1948-49).  
b. L. Katz, "Pyrotechnics in Missile Design," *Ordnance* **44**, 334 (1959).  
c. H. Ellern, "Military Pyrotechnics," *Ordnance* **44**, 662 (1960).
2. T. L. Davis, *Chemistry of Powder and Explosives*, John Wiley & Sons, Inc., New York, 1943.
3. H. B. Faber, Vol. 1, *The History and Development of Military Pyrotechnics*, U. S. Government Printing Office, Washington, D. C., 1919.
4. S. Sage and R. W. Evans, "Pyrotechnic Research Comes of Age," *Ordnance* **48**, 262 (1964).
5. Alan St. H. Brock, *A History of Fireworks*, George C. Hanap and Co., Ltd., London.
6. A. M. Prentiss, *Chemicals in War*, McGraw-Hill Book Co., New York, 1937.
7. K. F. Sawyer, "Screening Smokes," *Thorpe's Dictionary of Applied Chemistry*, Vol. X, p. 781, Logmans Green, London, 1950.
8. *History of Research and Development of the Chemical Warfare Service in World War II*, published for The Chemical Corps Association, Washington, D. C., Reinhold, N. Y., 1948.
9. L. P. Brophy, D. M. Syndam, R. C. Cockrane, *The Chemical Warfare Service from Laboratory to Field*, Office of the Chief of Military History, Department of the Army, Washington, D. C., 1959.
10. C. H. Custard, G. Francis, W. Schnackenberg, *Small Arms Incendiary Ammunition, A Review of the History and Development*, Frankford Arsenal Report R-1407-3, December 1956.
11. L. Finkelstein, A. E. Gaul, *Incendiaries*, Vol. 18, *History of Research and Development of Chemical Warfare Service in World War II*, published for The Chemical Corps Association, Washington, D. C., Reinhold, N. Y., 1948.
12. D. Hart, *Research and Development of Military Pyrotechnics*, Picatinny Arsenal, Dover, N. J., 1955.

## CHAPTER 2

## INTRODUCTION TO MILITARY PYROTECHNICS

## 2-1 INTRODUCTION

Modern military pyrotechnics as an outgrowth of "Greek Fire" and the "art of making fireworks" has progressed to the extent where pyrotechnic devices and systems in both offensive and defensive military operations have become indispensable. It has developed into a science requiring extensive and intensive basic and applied research to meet new conventional and unique military and space requirements.

The early modest state of progress was changed considerably, however, when military operations became mechanized with the development of the tank, the bombing plane, the submarine, long-range artillery, the aircraft carrier, other vehicles, and weapons; and the introduction of combined operations. To coordinate all these forces and to provide for visual communications between plane and tank, tank and artillery, infantry and air force, both day and night, the development of pyrotechnic ammunition for these purposes was absolutely essential. Increased use of aircraft for bombing and observation purposes required the use of flares and photoflash bombs which could be released from rapidly moving planes to illuminate enemy territory for night photography and observation and to locate targets for bombing.

A variety of smoke signals, spotting charges, bombardment flares, illuminating shells, ground and aircraft signals had to be developed to satisfy new tactical requirements. New demands for signaling capability required the development of improved colored smokes and signals.

For submarine identification and air-sea rescue operations, sea water activated, battery-operated, floating marking signals were developed with good life and stability. Many types of simulators for land and sea troop training were also developed and became an indispensable aid in these operations.

With the advent of the space age, pyrotechnic devices have become increasingly important. They are used extensively for spotting and tracking rockets and missiles, for recovery operations, and for special purpose countermeasures. To meet the requirements for these applications, it has been necessary to investigate pyrotechnic reactions under conditions of low pressure, low temperature, greatly reduced quantities of atmospheric oxygen, varied degrees of confinement, and with different types of initiating systems.

Basic studies have been undertaken to attain a fundamental understanding of the preignition, ignition, and self-propagative reactions of pyrotechnic ingredients. Theories have been developed which are used as a guide for formulating flame compositions burning cigarette-fashion, with specific burning rate requirements. Theoretical and empirical relationships have been developed to predict the rates of propagative burning of slow-burning pyrotechnics as a function of particle size and composition. Instrumentation has been developed to evaluate luminous intensity and colors of pyrotechnic flames, luminous intensity and duration of flashes, color of smoke clouds, and improved output of pyrotechnic flares. Laboratory studies include use of thermal analytical techniques, spectrophotometric and chromatographic analyses.

To continue to meet new challenges, principles and theories of engineering and science must be exploited and put to practice. Only when this is done will it be possible to elucidate reaction mechanisms, performance of pyrotechnic devices and to develop superior compositions and items.<sup>1,2,3,4,5,8</sup>

2-1.1 PYROTECHNIC DEVICES  
AND USES<sup>1,2,6,7,9,10</sup>

The terminal effect of military pyrotechnic items such as light, heat, smoke or sound results from an exothermic oxidation—reduced chemical

**TABLE 2-1**  
**TABULATION OF PYROTECHNIC DEVICES**

---

1. *Flares*
  - a. Reconnaissance
  - b. Observation
  - c. Bombardment
  - d. Deplaning and emplaning of troops and materiel
  - e. Prevention of enemy infiltration or reconnaissance
  - f. Target identification
  - g. Battlefield illumination
  - h. Marking targets and bomb release lines
  - i. Emergency airstrip location and identification
  - j. Decoys
  - k. Missile tracking
2. *Signals*
  - a. Between various elements of ground troops
  - b. Between ground troops and planes, or vice versa
  - c. Between planes in the air
  - d. Search and rescue operations (locate survivors)
  - e. Submarine to surface or air
  - f. Precision location of point or time in space for assessment of missile function
  - g. Establishment of points on a trajectory
3. *Colored and White Smokes*
  - a. For daytime signaling
  - b. For screening
  - c. For spotting
  - d. For marking targets
  - e. Thermal attenuating screen
  - f. Dissemination of chemical agents
  - g. Tracking and acquisition
  - h. Rescue
4. *Tracers*
  - a. To trace trajectories of projectiles or rockets
  - b. For self-destruction of ammunition after a definite time interval
5. *Incendiaries*
  - a. For use against ground targets
  - b. For use against aircraft targets
  - c. For emergency document and equipment destruction
6. *Pyrotechnic Delays*

Time delay for explosive trains
7. *Photoflash Bombs and Cartridges*

Aerial night photography
8. *Spotting and Tracking*

TABLE 2-1 (cont'd)

9. *Atmosphere and Space Studies*
10. *Simulated Ammunition for Troop Training*
11. *Rocket Igniters*
12. *Fuel Igniters for Ramjet Engines and Guided Missiles*
13. *Aircraft Engine Igniters*
14. *Water Markers*
15. *Heat Sources*
16. *Special Devices*

reaction within a mixture of a fuel and an oxidant. Additives or modifiers may be included to produce more saturated colored flames, to adjust burning rates, to produce colored smoke clouds, and to increase storage life and processing safety.

Pyrotechnic devices are employed in such a large variety of munitions that classification is difficult. These devices are, however, tabulated, with their principal uses, in Table 2-1.

### 2-1.2 CHARACTERISTICS OF PYROTECHNIC COMPOSITIONS<sup>1,2,4,6,7</sup>

The applicability of a specific pyrotechnic mixture for a particular application is governed by many 'yardsticks.' Consideration must be given, not only to the terminal effectiveness and output desired, but also to overall performance and reproducibility, and processing and storage characteristics. Precise and analytical determination of the various parameters involved requires continued research to develop improved evaluative methods.

The more important characteristics of pyrotechnic compositions used for military purposes may be stated as follows:

#### 2-1.2.1 Performance Characteristics

a. Heat of reaction. cal/gm or cal/cc. May be used as a basic criterion for selection of fuel-oxidizer combinations.

b. Burning rate. inches/second, inches per minute, seconds/inch. Applied to consolidated mixtures and measured as a linear rate.

c. Luminous intensity. candela or candlepower. Visible output or illumination in candela.

d. Color value. The color quality of a colored pyrotechnic flame taken as the ratio of the apparent

luminous intensity through an appropriate colored filter to the total luminous intensity.

e. Visibility. Applied to illuminating and signal devices; measured in terms of brightness and other qualities.

f. Efficiency. Relates the output to the original weight or volume of compositions; for illuminating or signaling it is expressed as candle/seconds per gram or per milliliter; for smoke-producing devices efficiency is considered to be the percent of chemical vaporized based either on the weight of chemical originally contained or on the total weight of munition, depending on the requirements of the evaluator.

g. Color and volume of smoke. Compared to standard charts or by observers' ability to detect and recognize, at prescribed distances, the color and the total obscuring power (TOP).

#### 2-1.2.2 Processing and Sensitivity Characteristics

Information on the processing, storage, shipping, and sensitivity characteristics of pyrotechnic compositions can be found in Part Two of this series, AMCP 706-186.

#### 2-1.2.3 General Functioning Characteristics

a. Ignitibility. The ease with which a pyrotechnic composition ignites, determined by standard time-to-ignition tests described in Part Two of this series, AMCP 706-186.

b. Hygroscopicity. The ease with which a composition picks up moisture at a preselected temperature and relative humidity.

c. Reaction characteristics. Fundamentally important are the heat of reaction and rate of reaction of a pyrotechnic composition. To make a consolidated composition burn propagatively, sufficient heat must be evolved and the rate of reaction must

be of sufficient magnitude to more than compensate for heat losses.

In addition to the heat of reaction and the rate of reaction, display characteristics are influenced by many other factors. Some of the more important include :

1. Granulation or particle size of ingredients
2. Composition of ingredients
3. Purity of ingredients
4. Burning surface area
5. Heat transfer characteristics
6. Flare case material and configuration
7. Loading pressure
8. Presence of moisture
9. Degree of confinement
10. Ambient temperature and pressure
11. Method of ignition
12. Length-to-diameter ratio
13. Method and energy of dissemination
14. Bomb burster geometry
15. Velocity, acceleration and aerodynamics of device

The importance of a particular influential factor may vary considerably with the application. Factors such as the average particle diameter, specific surface, shape, and distribution will affect the burning rate of consolidated pyrotechnic mixtures. Changes in the general characteristics of the flare case and the area of the burning surface combine to influence the output of flame producing items. With pyrotechnic delay compositions, the burning rate is of primary significance and may be varied by changes in the percentages and particle size of the ingredients in the composition, incorporating additives, varying the compaction, and by other means. Noneconsolidated pyrotechnic photoflash mixtures used in flash items are influenced by the method of ignition, ratio of length to diameter, burster geometry, and degree of confinement.

In addition, there are many other factors peculiar to the specific item under consideration that may exert varying influences on performance. In the design and development of new pyrotechnic munitions, a fresh approach should always be considered, using the data available on existing devices only as a guideline.

### 2-1.3 Constituents in Pyrotechnic Compositions<sup>1,2,4,6,7</sup>

The constituents upon which the performance of pyrotechnic compositions and devices is dependent include a basic fuel and oxidizer combination with other ingredients. These may consist of dyes, color intensifiers, retardants, binding agents, water-proofing agents, and substances to create a specific effect.

Typical ingredients in each of these categories are :

1. Oxidizing Agents. Nitrates, perchlorates, peroxides, oxides, chromates and chlorates. These are all substances in which oxygen is available at the high temperatures of the chemical reaction involved. In addition, fluorinating agents such as Teflon and Kel-F are finding use as oxidizing agents.

2. Fuels. Metal powders, metal hydrides, red phosphorus, sulfur, charcoal, boron, silicon, silicides. When these substances are finely powdered, they readily undergo an exothermal oxidation with the formation of corresponding oxides and the evolution of heat and radiant energy.

3. Color Intensifiers. Highly chlorinated organic compounds, such as hexachloroethane ( $C_2Cl_6$ ), hexachlorobenzene ( $C_6Cl_6$ ), polyvinylchloride, and dechlorane ( $C_{10}Cl_{12}$ ). These compounds are utilized to produce specific spectral emitters in pyrotechnic flames.

4. Retardants. Inorganic salts, plastics, resins, waxes, oils. These are used to slow down the reactions between the oxidizing agent and the powdered metal to produce the desired burning rate. Some behave merely as inert diluents while others participate in the reaction at a much slower rate than the main constituents.

5. Binding Agents. Resins, waxes, plastics, oils. These are added to prevent segregation and to obtain more uniformly blended compositions. In addition, they serve to make finely-divided particles adhere to each other when compressed into pyrotechnic items and help to obtain maximum density and burning efficiency. Binders also frequently desensitize mixtures which are otherwise sensitive to impact, friction and static electricity.

6. Waterproofing Agents. Resins, waxes, plastics, oils, dichromating solutions. These are used

**TABLE 2-2**  
**COMPARISON OF SOME PROPERTIES OF PYROTECHNIC**  
**COMPOSITIONS WITH EXPLOSIVES**

Composition	%	Cal/gram	Noncon- densable Gas Volume, cc/gram	Brisance, Grams Sand Crushed	Ignition Temp*, °C	Impact BM**, Cm	PA***, in.
<b>PYROTECHNIC :</b>							
<i>Delay</i>							
Barium chromate	90						
Boron	10	480	13	0	650	—	12
<i>Delay</i>							
Barium chromate	60						
Zirconium-nickel alloy	26						
Potassium perchlorate	14	497	12	0	485	56	23
<i>Flare</i>							
Sodium nitrate	38						
Magnesium	50						
Laminae	5	1456	74	8	640	60	19
<b>Smoke</b>							
Zinc	69						
Potassium perchlorate	19						
Hexachlorobenzene	12	616	62	8	475	23	15
<i>Photoflash</i>							
Barium nitrate	30						
Aluminum	40						
Potassium perchlorate	30	2147	15	7	700	100	26
<b>HIGH EXPLOSIVE :</b>							
TNT		1060	1000	48	475	100	14
RDX		1240	600	60	260	13	5
<b>BLACK POWDER</b>		<b>684</b>	<b>272</b>	<b>8</b>	<b>288</b>	<b>32</b>	<b>16</b>

\* 5-second value

\*\* Bureau of Mines

\*\*\* Picatinny Arsenal

as protective coatings on metals such as magnesium, aluminum and zirconium-nickel alloys to reduce their reaction to atmospheric moisture.

7. Dyes for Smokes. **Azo** and anthraquinone dyes. These dyes provide the color for smokes used for signaling, marking, and spotting.

Many of the above substances perform more

than one function, thus simplifying the composition of some pyrotechnic mixtures.

#### 2-1.4 Comparison of Pyrotechnic Mixtures and Explosives<sup>1,2,6,10</sup>

Pyrotechnic mixtures can be devised to produce as little as **200** calories per gram of mixture or in

excess of 2000 calories per gram. Reaction temperatures exceed 3000°K in some cases.

Such amounts of energy and the high temperatures attained can be extremely dangerous. In general, because the quantity of gas produced is less, and the release of energy is at a lower rate, the terminal effects produced by pyrotechnic compositions are less severe than those produced by high

explosives.

A comparison of some of the more important properties of pyrotechnic compositions and explosives is given in Table 2-2. As indicated in this table, pyrotechnic compositions, in general, are not as sensitive to heat as explosives. Impact values listed indicate that some pyrotechnic compositions are at least as sensitive to shock as explosives.

## REFERENCES

1. G. Weingarten, *Chemistry of Pyrotechnics*, oral presentation at Picatinny Arsenal, Dover, N. J., 1955.
2. D. Hart, *Research and Development of Military Pyrotechnics*, Picatinny Arsenal, Dover, N. J., 1955.
3. S. Sage and R. W. Evans, "Pyrotechnic Research Comes of Age," *Ordnance* **48**, 262 (1964).
4. H. Ellern, *Modern Pyrotechnics*, Chemical Publishing Co., 1961.
5. L. Katz, "Pyrotechnics in Missile Design," *Ordnance* **44**, 334 (1959).
6. TM 9-1910, *Military Explosives*.
7. TM 9-1370-200, *Military Pyrotechnics*.
8. H. Ellern, "Military Pyrotechnics," *Ordnance* **44**, 662 (1960).
9. T. C. O'Hart, *Elements of Ammunition*, John Wiley & Sons, N. Y., 1946.
10. T. L. Davis, *Chemistry of Powder and Explosives*, John Wiley & Sons., N. Y., 1943.



## CHAPTER 3

## PHYSICAL-CHEMICAL RELATIONSHIPS

The output characteristics of a pyrotechnic munition are determined, to a large extent, by the temperatures to which the reaction products are heated as a result of the chemical reaction between the fuel and oxidizer. The maximum temperature of the reaction products depends on: (1) the state of the products at the reaction temperature, (2) the heat evolved by the exothermal chemical reaction, and (3) the rate of heat production and heat loss. Physical-chemical relationships allow the state of the products, the energy released, and the maximum reaction temperature to be calculated. The rate of heat production and heat loss, which are influenced by the ambient temperature and pressure, confinement, and many other inter-related factors, can also be calculated for certain simple cases. However, for most reactions, these quantities must be determined experimentally.

The physical-chemical relationships which are applicable to pyrotechnics are summarized in this chapter, and pertinent examples are given to illustrate their application.

## 3-1 STATE OF A SYSTEM

The state of any system (gas, liquid, or solid) can be described by specifying a sufficient number of its properties such as mass, volume, temperature, and pressure. These properties are classified as: (1) extensive properties which depend on the size of the system, and (2) intensive properties which are independent of the size of the system. It is unnecessary to specify all the properties of a system in order to characterize its state; two independent variables, commonly the intensive variables of pressure and temperature, are sufficient for a given amount of pure substance. A mathematical expression for this relationship is an equation of state which, for one mole of a pure substance with volume as the dependent variable, has the form:

$$V = f(T, p) \quad (3-1)$$

Similar expressions can be written with  $T$  and  $p$  as the dependent variable. If a system has  $n$  components,  $n-1$  composition variables must be specified.

## 3-1.1 THE GASEOUS STATE

The gaseous state is characterized by changes in volume with changes in temperature and pressure. Gases normally have no bounding surface and, therefore, tend to completely fill any available space. A knowledge of the behavior of gases with changes in temperature and pressure is essential because of the importance of the gaseous state at the high temperatures involved in pyrochemical reactions.

Gaseous products formed in the combustion of many pyrotechnic mixtures may range from essentially zero, for most thermites and some types of delay mixtures, to 15 to 20 percent for light-producing compositions, to 50 percent for some smoke-producing mixtures. At the high temperatures produced by the burning of pyrotechnic compositions, many substances not usually considered gaseous will exist in the gaseous state. The formation of gas, both as a permanent product and as an intermediate product which exists only during the reaction, is indicated in light-producing mixtures by the presence of a flame. Gaseous combustion products are necessary in smoke-producing mixtures to aid in the formation of dispersed, particulate matter and to carry this matter into the atmosphere.

## 3-1.1.1 Ideal Gases

The behavior of gases at low pressures and high temperatures is often approximated by an equation of state known as the ideal gas law:

$$pv = nRT = \frac{W}{M}RT \quad (3-2)$$

where  $p$  is the pressure,  $v$  is the volume,  $n$  is the

number of moles,  $R$  is the universal gas constant,  $T$  is the absolute temperature,  $W$  is the weight of gas, and  $M$  is the molecular weight of the gas, using any set of consistent units. The density  $d$  of an ideal gas at various temperatures and pressures is:

$$d = \frac{W}{v} = \frac{pM}{RT} \quad (3-3)$$

The ideal gas law applies, strictly, to a hypothetical gas, which is composed of mass points between which no forces are acting. At the high temperatures and relatively low pressures produced by burning unconfined pyrotechnic compositions, the ideal gas law is fairly accurate. At the higher pressures which may be produced when a confined pyrotechnic composition is burned, the behavior may deviate appreciably from that of an ideal gas.

### 3-1.1.2 The Universal Gas Constant and Standard Conditions

It has been determined that one mole of an ideal gas occupies 22.414 liters at 273.16°K and one atmosphere. Then, from Equation 3-2:

$$R = \frac{pv}{T} = \frac{(1)(22.414)}{(273.16)} = 0.08205 \frac{\text{liter-atm}}{\text{°K mole}} \quad (3-4)$$

The universal gas constant  $R$  has the units of energy per degree-per mole. It may be calculated from Equation 3-4 for one mole of gas at standard conditions. The value of  $R$  must be consistent with the units of pressure, temperature, and volume used in the ideal gas law. Some values of  $R$  include:

Value	Units
0.08205	liter atmospheres
10.73	gram mole degree Kelvin psia cubic feet
1.987	pound mole degree Rankine calories
1.987	gram mole degree Kelvin BTU
	pound mole degree Rankine

In some references, including many of those dealing with rocket propulsion, a gas constant  $R'$  may

be given in weight units of a particular gas instead of in moles. In this case:

$$R' = \frac{R}{M} \quad (3-5)$$

where  $M$  is the molecular weight of the gas, and  $R$  is the universal gas constant.

### 3-1.1.3 Real Gases

In a real gas, the forces acting between the molecules as well as the volume of the molecules cause deviations from ideal behavior. Several equations of state have been proposed to more closely approximate the behavior of real gases. Some of these equations of state include:

*Van der Waal's Equation*

$$\left( p + \frac{n^2a}{V^2} \right) (v - nb) = nRT \quad (3-6)$$

where  $a$  is a correction for the forces between molecules of a real gas, and  $b$ , termed the co-volume, is a correction for the volume of the molecule. The units used for  $a$  and  $b$  must be consistent with those used for the other variables.

*Abel's Equation:*

$$(p)(v - nb) = nRT \quad (3-7)$$

where  $b$  is the correction for the volume of the molecules. This equation, which is a modification of *Van der Waal's Equation*, applicable where the pressure is high, has been quite widely used for calculations involving explosives and propellants.

*Virial Equation:*

$$pv = nRT \left( 1 + \frac{B}{v} + \frac{C}{v^2} + \dots \right) \quad (3-8)$$

where the coefficients  $B$ ,  $C$ , etc., vary with temperature and are called the second, third, etc., virial coefficients. This particular equation is a very general equation of state for real gases. By using enough terms, the values calculated from the above equation can be made to agree with experimental data as closely as desired.

*Compressibility Factor*

The deviation of a gas from ideal behavior can also be expressed by the use of a compressibility factor  $K$  where:

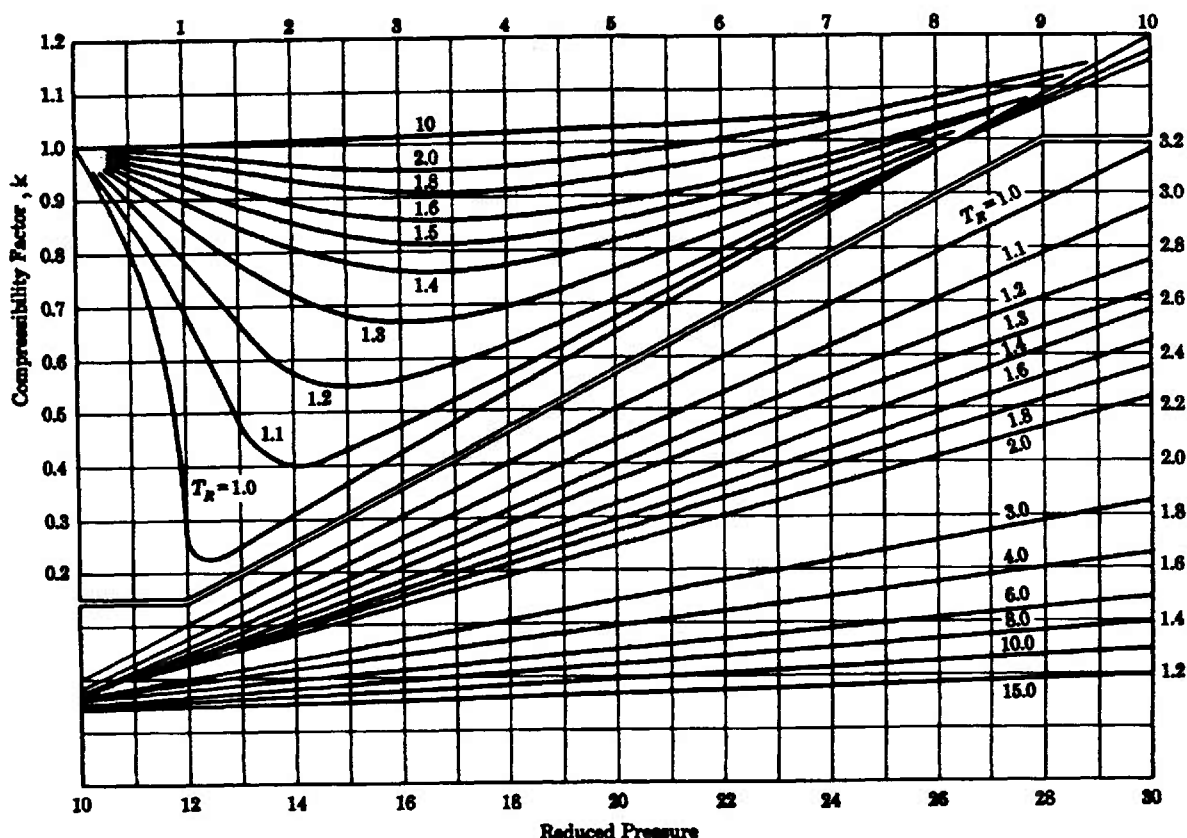

Figure 3-1. Compressibility Factors as a Function of Reduced Pressure

$$K = \frac{pv}{nRT} \tag{3-9}$$

or, in terms of reduced variables:

$$K = (\text{Constant}) \left( \frac{p_r V_r}{T_r} \right) \tag{3-10}$$

in which a reduced variable is the variable divided by its value at the critical point, i.e.:

$$p_r = (p/p_c), T_r = (T/T_c), \text{ and } V_r = V/V_c \tag{3-11}$$

The critical point is defined when the properties of a liquid and gas phase which are in equilibrium become identical. The  $p$ ,  $v$ , and  $T$  quantities, associated with this critical point, are defined as  $p_c$ ,  $v_c$  and  $T_c$ . Therefore, as predicted by the law of corresponding states, if  $K$  is plotted against  $p_r$  at a given  $T_r$ , a single curve will result for all gases as shown in Figure 3-1. The compressibility factor estimated from these curves

allows a value for any one of the three variables  $p$ ,  $v$ , and  $T$  to be calculated in terms of the other variables with a fair degree of accuracy. The compressibility factor can be determined experimentally or by calculation using a suitable equation of state.

### 3-1.1.4 Gas Mixtures

Gas mixtures are normally treated by Dalton's Law, i.e.,

$$p_{total} = p_1 + p_2 + \dots = \sum_{i=1}^n p_i \tag{3-12}$$

where the partial pressure  $p_1$  of each of the components is defined as the pressure which would be exerted if it occupied the total volume at the same temperature. Gas mixtures can also be treated by the Amagat additive volume law:

$$v_{total} = v_1 + v_2 + \dots = \sum_{i=1}^n v_i \quad (3-13)$$

where the volumes of the individual components  $v_1, v_2, \dots$  are the volume each would occupy at the (total) pressure and temperature of the mixture. For ideal gas mixtures, the results obtained with this equation will be the same as those obtained by use of the additive pressure law. The

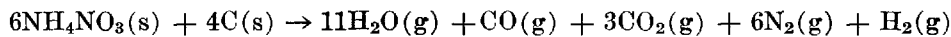

(a) The volume of gas produced per gram of mixture burned at standard temperature and pressure can be calculated from the above reaction and the ideal gas law. The reaction produces 22 moles of product gases from 6 moles of  $\text{NH}_4\text{NO}_3$  (480 grams) plus 4 moles of charcoal (48 grams) or a total of 528 grams of fuel block.

Moles of gas per gram of fuel block burned:

$$\frac{22}{528} = 0.041 \text{ moles per gram}$$

Volume of gas produced (STP) per gram of fuel block burned is:

$$V = \frac{nRT}{p} = \frac{(0.041)(0.082)(273)}{1} = 0.918 \text{ liters per gram}$$

(b) Since the actual temperature of the product gases is  $1000^\circ\text{C}$ , the calculated volume at this temperature and one atmosphere would be considerably greater :

$$V_{1000^\circ\text{C}} = \frac{1273}{273}(0.918) = 4.28 \text{ liters per gram}$$

(c) The partial pressure of one of the gaseous products may be found by using the ideal gas law and moles of the component desired and the total volume for  $n$  and  $V$ . The partial pressure of carbon dioxide would be calculated as follows :

$$P_{\text{CO}_2} = \frac{n_{\text{CO}_2}RT}{V_{total}} = \frac{(3/528)(0.082)(273)}{0.918} = 0.14 \text{ atmosphere}$$

Since the partial pressure is proportional to the mole fraction of each gaseous component, a simpler method would be:

application of both of these laws to real gas mixtures is somewhat more difficult.<sup>1</sup>

### 3-1.15 Sample Calculations

Example One: Analysis of the product gases produced by a burning fuel block composition, containing ammonium nitrate and charcoal, indicates that the reaction taking place could be represented by the overall reaction:

$$P_{\text{CO}_2} = \frac{\text{Moles}_{\text{CO}_2}}{\text{Moles}_{total}} (P_{total}) = 3/22 (1) = 0.14 \text{ atmosphere}$$

Example Two: A cylinder having a volume of one liter is pressurized to 200 atmospheres with carbon dioxide at a temperature of  $40^\circ\text{C}$ . The amount of carbon dioxide can be calculated by:

(a) Assuming carbon dioxide behaves as an ideal gas :

$$v = \frac{pVM}{RT} = \frac{(200)(1)(44)}{(0.082)(313)} = 343 \text{ grams}$$

(b) Assuming that carbon dioxide behaves as a Van der Waal's gas :

$$\left[ p + \frac{\left(\frac{w}{M}\right)^2 a}{v^2} \right] \left[ v - \left(\frac{w}{M}\right) b \right] = \frac{w}{M} RT$$

For  $\text{CO}_2$ ,  $a = 3.59 \text{ liters}^2 \text{ atm mole}^{-2}$ ;  $b = 0.0427 \text{ liter mole}^{-1}$

$$\left[ 200 + \frac{\left(\frac{w}{44}\right)^2 (3.59)}{(1)^2} \right] \left[ 1 - \left(\frac{w}{44}\right) (0.0427) \right] = \frac{w}{44} (0.082)(313)$$

Solving cubic equation in  $w$  :  $w = 625 \text{ grams}$   
 (c) Use of the generalized compressibility chart, Figure 3-1:

Critical pressure carbon dioxide = 72.9 atmospheres  
 Critical temperature carbon dioxide =  $304.2^\circ\text{K}$

$$p_r = \frac{200}{72.9} = 2.75$$

$$T_r = \frac{313}{304.2} = 1.03$$

From Figure 3-1,  $K = 0.42$

$$w = \frac{pvM}{KRT} = \frac{(200)(1)(44)}{(0.42)(0.082)(313)} = 608 \text{ grams}$$

The experimentally determined value is 835 grams.

### 3-1.2 THE LIQUID STATE

A liquid, like a gas, has no definite shape and, hence, takes the shape of the vessel in which it is placed. The surface of a liquid, in the absence of other forces, will tend to contract to a minimum area and is responsible for many of its characteristic properties. The molecules of a liquid are less mobile than those in gases but more mobile than those in solids.

In pyrotechnic reactions, liquids are formed by the melting of solids and condensation of vapors. Liquid fuels must be vaporized before sustained combustion will take place. The burning of many solid fuels, including most of the metal fuels, involves the formation and vaporization of a liquid phase as a step in the combustion process.

#### 3-1.2.1 Vapor Pressure

The pressure exerted by a vapor, in equilibrium with a liquid, is the vapor pressure of the liquid. The vapor pressure increases with temperature until the critical temperature is reached above which the liquid cannot exist. The vapor pressure at the critical temperature is termed the critical pressure. The increase in vapor pressure with temperature can be approximated by the empirical equation:<sup>2</sup>

$$\log p = \frac{-0.05223a}{T} + b \quad (3-14)$$

where  $p$  is the vapor pressure in millimeters of mercury,  $T$  is the absolute temperature °K, and  $a$  and  $b$  are empirically determined constants for each liquid. For example, aluminum oxide in the temperature range 1840°C to 2200°C has constants of 540,000 and 14.22 for  $a$  and  $b$ , respectively. At 2100°C, the vapor pressure of the liquid would be:

$$\log p = \frac{-0.05223(540,000)}{2373} + 14.22$$

$$\log p = 2.32$$

$$p = 210 \text{ mm mercury}$$

The vapor pressure of small droplets, such as mist droplets, is higher than the bulk vapor pressure. If  $p_o$  is the bulk vapor pressure of the liquid, the vapor pressure of a droplet  $p$  is given by:

$$p = p_o \left( 1 + \frac{2\gamma M}{rd RT} \right) \quad (3-15)$$

where  $\gamma$  is the surface tension,  $M$  is the molecular weight,  $d$  is the density of the liquid,  $r$  is the radius of the drop,  $R$  is the universal gas constant, and  $T$  is the absolute temperature.

#### 3-1.2.2 Boiling Point

The temperature at which the equilibrium vapor pressure of a liquid equals the ambient pressure on the surface of the liquid is known as the boiling point. If the ambient pressure is one atmosphere, the temperature at which the liquid boils is termed the normal boiling point. For many liquids, the normal boiling point is approximately two-thirds of the critical temperature. According to Trouton's Rule, the number of calories required to vaporize one mole of many liquids, including some of the metals, is about twenty-one times its normal boiling temperature (degrees Kelvin). By use of Trouton's Rule, the heat of vaporization of some of the metal fuels can be approximated if the boiling temperature is known.<sup>3</sup>

Lithium has a boiling point of 1331°C (1604°K) and its reported heat of vaporization is 32,190 calories per mole. Applying Trouton's Rule:

$$AH_{,,} = 1604(21) = 33,700 \text{ calories per mole}$$

### 3-1.3 THE SOLID STATE

Solids have a fixed shape and volume with the individual units (atoms, molecules or ions) so firmly bound together that there is little freedom for translational motion. Crystalline solids exhibit orderly internal arrangements and exhibit a sharp melting point. Crystals whose properties are different along different axes of the crystal are called anisotropic; if the properties are the same, they are called isotropic. Amorphous solids (such as

glass) may be regarded as super-cooled liquids of high viscosity. They have indefinite melting points and undefined internal arrangements.

The properties of solids are important to the study of pyrochemical reactions, which involve solid ingredients reacting to produce mainly solid products. Intermediate steps in the reaction involve liquid and gaseous phases; however, some pyrochemical reactions may proceed by a solid-solid reaction mechanism.

There are 230 possible crystal forms which can be grouped into 32 classes which, in turn, can be referred to one of the following six crystal systems:

1. Cubic. Three axes of equal length intersecting each other at right angles.
2. Tetragonal. Three axes intersecting each other at right angles with only two of the axes equal in length.
3. Hexagonal. Three axes of equal length in a single plane intersecting at 60° angles, and a fourth axis of different length and perpendicular to the plane of the other three.
4. Rhombic. Three axes of unequal length intersecting at right angles.
5. Monoclinic. Three axes of unequal length, two of which intersect at right angles.
6. Triclinic. Three axes of unequal length, none of which intersect at right angles.

The macroscopic symmetry of crystals is due to the regularity of the arrangements of the elemental particles (atoms, ions, or molecules) in a lattice consisting of a three-dimensional repetition of some structural unit of fixed dimensions. The *unit cell* is the smallest unit of the crystal lattice which retains all the symmetry of the macroscopic crystal. In general, there are several possible arrangements of elementary particles which will have the symmetry associated with a given crystal system, such as the cubic system.

There are three possible arrangements of space lattices for the cubic system. As illustrated in Figure 3-2 they are:

1. Simple cubic lattice. One structural unit at each corner of the cube.
2. Face-centered cubic lattice. One unit at each corner of the cube and one unit in the center of each face of the cube.

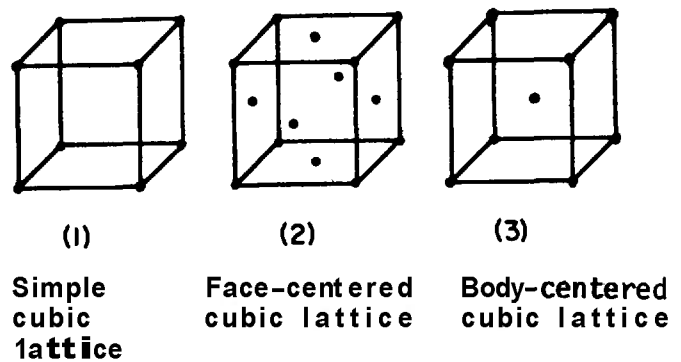

Figure 3-2. Cubic lattices

3. Body-centered cubic lattice. One unit at each corner of the cube and one unit in the center of the cube.

X-rays may be used to determine the internal structure of crystalline materials, which can be calculated by Bragg's Law:

$$nh = 2d \sin \Theta \quad (3-16)$$

where  $n$  is the order of reflection,  $h$  is the wavelength of the X-rays,  $d$  is the distance between two planes, and  $\Theta$  is the angle of reflection.

X-ray techniques are employed to identify many solid products of combustion from pyrotechnic reactions.<sup>4</sup> This is especially useful when analysis of a particular product's mixture would not be practical by wet, chemical methods and where retention of the sample is desired.

Solids can be divided into three classes based upon their thermal and electrical conductivities:

1. Conductors or metals which have high conductivities which decrease with an increase in temperature.
2. Insulators which have low conductivities.
3. Semi-conductors which have intermediate conductivities which increase with rising temperature, usually as  $e^{-A/T}$  where  $A$  is a constant and  $T$  is the absolute temperature.

The thermal and electrical conductivity of pyrotechnic ingredients may be contributing factors affecting the performance of a particular item. The thermal conductivity, which is of greater significance, influences the conductive heat transfer characteristics. These properties become very important in devices dependent on a functional transfer of heat such as a "pyro-switch." Such devices may be normally closed or normally open

and will either be conducting or nonconducting following the pyrotechnic reaction.

The properties of solids are markedly affected by defects<sup>5</sup> in crystal structure. Small amounts of impurities in an insulating material may make the material a semi-conductor. Such doped materials may also exhibit enhanced chemical activities. Departure of a crystalline compound from chemical stoichiometry, due to incorporation of extra atoms into the crystal at interstitial sites or to vacancies caused by the absence of atoms from normal sites, also results in semi-conductivity.

Point defects, including those in which an ion moves from its lattice site to an interstitial position (Frenkel defect), or those in which a pair of ions of opposite charge are missing from their lattice site (Schottky defect), do not alter the exact stoichiometry of the solid but do provide a means by which atoms can move in the solid phase. Linear defects, dislocations, provide another means for atoms to move with respect to each other in the solid phase. These defects provide mechanisms for many of the processes which occur in the solid state. They provide sites at which chemical reactions and physical changes can take place readily. The point of emergence of a dislocation at the surface is a site of increased chemical reactivity.

The presence of crystal defects in pyrotechnic ingredients can have a marked influence on the course of the reaction and, therefore, influence the characteristic behavior (including stability and output) of pyrotechnic compositions.

## 3-2 THERMODYNAMICS

Thermodynamics is the study of the quantitative relationships between heat and other forms of energy. In all cases, energy can be expressed as the product of two factors, an intensity factor (i.e., temperature difference), and a capacity factor (i.e., heat capacity). In the reaction of a pyrotechnic composition, the chemical energy is converted into other forms of energy, primarily heat and work. The products of combustion are heated to the reaction temperature, and, if unconfined, work can be done against the atmosphere.

In the following paragraphs, certain basic laws of thermodynamics, thermochemistry, chemical equilibrium, the concept of free energy, etc., are

discussed showing their application in the field of pyrotechnics. Selected calculations, including those for adiabatic flame temperatures, which are important to the overall analysis of chemical reactions, are also presented.

### 3-2.1 THERMODYNAMIC RELATIONSHIPS

Thermodynamics is based on three laws and the implications derived from these laws. The application of certain thermodynamic relationships derived from the three laws is a useful tool for use in predicting the performance and outcome of many physico-chemical systems.

#### 3-2.1.1 First Law of Thermodynamics

The first law of thermodynamics is a statement of the law of conservation of energy, i.e., that energy can be neither created nor destroyed.

The first law of thermodynamics can be expressed mathematically :

$$\Delta E = q - w \quad (3-17)$$

where  $q$  is the energy in the form of heat, transferred into or out of the system;  $w$  is the energy, in the form of work transferred to or from the system; and  $\Delta E$  is the change in internal energy. If the system absorbs heat,  $q$  has a positive value; if the system does work,  $w$  has a positive value. The value of  $\Delta E$  depends only on the initial and final state of the system. The quantities  $q$  and  $w$  depend on the path taken from the initial to the final state. For a cyclic process, i.e., a process which has the same initial and final stage,  $\Delta E = 0$  so that  $q = w$ .

##### 3-2.1.1.1 Heat Effects at Constant Volume and Constant Pressure

The heat released by a pyrotechnic reaction can raise the temperature of the reaction products, cause phase changes, and cause other chemical reactions (such as dissociation) to take place. If a chemical reaction or physical change takes place at constant volume, and only pressure-volume work is considered, the amount of work done is zero and the heat effect accompanying the reaction is equal to the change in internal energy.

$$q_v = \Delta E \quad (3-18)$$

Chemical reactions, including many pyrotechnic reactions, and physical changes may also take place at constant pressure where only pressure-volume work is considered and the heat effect is equal to the internal energy change plus the work done in expansion.

$$q_p = \Delta E + p\Delta v \quad (3-19)$$

In this case, it is convenient to use another thermodynamic property, the enthalpy  $H$ , defined by:

$$H = E + pV \quad (3-20)$$

Then, for a chemical reaction or phase change occurring at constant pressure, when only pressure-volume work is considered:

$$\Delta H = \Delta E + p\Delta v \quad (3-21)$$

and the heat effect at constant pressure is equal to the change in enthalpy:

$$q_p = \Delta H \quad (3-22)$$

If gaseous products are assumed to behave ideally:

$$\Delta H = \Delta E + \Delta nRT \quad (3-23)$$

where  $\Delta n = \sum n(\text{products}) - \sum n(\text{reactants})$  for the gaseous materials involved in the reaction. Therefore, pyrotechnic reactions involving solid reactants and the formation of gaseous products where heat is evolved (exothermic) will have a higher heat of reaction at constant volume,  $\Delta E(q_v)$ , than at constant pressure,  $\Delta H(q_p)$ . In the latter case,  $q_p$  is reduced by the heat equivalent of the increased gaseous products,  $\Delta nRT$ . These relationships can be used to obtain values equivalent to the standard heat of reaction from bomb calorimetric measurements made at constant volume.

Pyrotechnic reactions take place under conditions of either constant volume, constant pressure, or combinations of both. Constant volume conditions occur for delay systems that are obturated, and constant pressure systems occur for flares, signals, smokes, and the like. In photoflash items, such as cartridges or bombs, the confined composition functions under constant volume conditions when initiated and it then continues to react at constant pressure when dispersed as the case ruptures.

### 3-2.1.1.2 Heat Capacity

The heat capacity of a system is defined as the quantity of heat required to raise the temperature  $1^\circ\text{C}$  or, expressed mathematically:

$$C = \frac{dq}{dT} \quad (3-24)$$

Under conditions of constant volume,  $dq = dE$ , Equation 3-18, and the heat capacity at constant volume is equal to the change in internal energy with temperature, or:

$$C_v = \left( \frac{\partial E}{\partial T} \right)_v \quad (3-25)$$

While the internal energy  $E$  is a function of the three variables  $T$ ,  $P$ , and  $v$ ; only two are required to define the system. A derivative, therefore, with respect to only one variable  $T$  is expressed as a partial derivative  $\left( \frac{\partial E}{\partial T} \right)_v$  with the subscript  $v$  denoting the variable to be held constant.

At constant pressure, the heat capacity includes both the heat absorbed to increase the internal energy plus the heat equivalent of the work term  $p dv$ . Since, under these conditions,  $dq = dH$ , Equation 3-22, the heat capacity at constant pressure is equal to the change in enthalpy with temperature, or:

$$C_p = \left( \frac{\partial H}{\partial T} \right)_p \quad (3-26)$$

The heat capacity at constant pressure can be calculated by equation of the form (either one):

$$\begin{aligned} C_p &= a + bT + cT^2 \\ C_p &= a + bT + cT^{-2} \end{aligned} \quad (3-27)$$

where  $a$ ,  $b$ , and  $c$  are constants. This type equation applies over a more or less limited range of temperatures and for many thermochemical calculations it is more convenient to use an average heat capacity defined by:

$$C_{p_{ave}} = \frac{\int_{T_1}^{T_2} C_p dT}{T_2 - T_1} \quad (3-28)$$

When necessary,  $C_v$  can be obtained by subtracting  $R$  (the universal gas constant) from the value for  $C_p$ .



Heat capacity values are essential for many thermochemical calculations involving pyrotechnics. The temperature attained by the products of a pyrotechnic reaction will depend, in part, on the heat capacity of these products. Calculations of the heat balance for a given system utilize the heat capacity to obtain the enthalpy change in going from one temperature and/or state to another. The latest tables, however, provide enthalpy changes directly, making it unnecessary to calculate heat capacities independently.

### 3-2.1.1.2.1 Heat Capacity of Gases

According to the kinetic theory of gases, the heat capacity of ideal gases, and of monatomic real gases such as helium and argon, to relatively high temperatures is :

$$C_v = 3/2 R = 3 \text{ cal/gmole } ^\circ K \quad (3-29)$$

$$C_p = C_v + R = 5 \text{ cal/gmole } ^\circ K \quad (3-30)$$

Diatomic real gases, including gases such as oxygen and nitrogen, and linear polyatomic molecules have two degrees of rotational freedom in addition to the three degrees of freedom associated with translational motion. At normal temperatures the heat capacities of these gases are approximately :

$$C_v \cong 5/2 R = 5 \text{ cal/gmole } ^\circ K \quad (3-31)$$

$$C_p \cong C_v + R = 7 \text{ cal/gmole } ^\circ K \quad (3-32)$$

### 3-2.1.1.2.2 Heat Capacity of Liquids and Solids

According to the law of Dulong and Petit, the molar heat capacities of solid elements (especially the metals)  $C_v$  and  $C_p$  are approximately 6 calories per gram-atom per degree-Kelvin. This is in agreement with the values of  $3R$ , i.e., 5.96 calories per gram-atom per degree-Kelvin, suggested by kinetic theory.

The molar heat capacities of solid compounds can be estimated by using Kopp's Rule which states that the heat capacity of a solid compound is approximately equal to the sum of the heat capacities of the constituent elements. In using this rule, the following atomic heat capacities are assigned to the elements: C, 1.8; H, 2.3; B, 2.7; Si, 3.8; O, 4.0; F, 5.0; P, 5.4; S, 5.4; and all others, 6.2.

Other methods are available for estimating heat

capacities of solids at higher temperatures.<sup>6</sup> Where these values are not available, the room temperature value may be used in conjunction with a value of 7.25 calories per gram-atom per degree-Kelvin for the next transition point, assuming a linear increase of  $C_p$  with temperature.

The heat capacities of molten inorganic substances do not differ greatly from those of solid materials. When handbook values are unavailable, Kopp's Rule may also be applied to compounds by assigning the following values of atomic heat capacities to the atoms of the liquid: C, 2.8; H, 4.3; B, 4.7; Si, 5.8; O, 6.0; F, 7.0; P, 7.4; S, 7.4, and to most other elements a value of 8.0.

Other methods for estimating heat capacities of liquids and solids are available.<sup>6</sup> In most cases, calculations are unnecessary, as the values have been experimentally determined and may be obtained from handbook tabulations.

The heat capacity of liquids and solids decreases considerably with a decrease in temperature and is zero at absolute zero. For temperatures below 50°K, the Debye Equation applies and:

$$C_v = 464.5 \frac{T^3 \text{ caloric}}{\Theta^3 \text{ degree-Kelvin gram-atom}} \quad (3-33)$$

where  $T$  is the absolute temperature in degrees-Kelvin, and  $\Theta$  is termed the characteristic temperature and is defined by :

$$\Theta = \frac{h\nu_m}{k} \quad (3-34)$$

where  $h$  is the Planck constant,  $k$  is the Boltzmann constant and  $\nu_m$  is the maximum vibration frequency. These values may be found in a suitable handbook.

### 3-2.1.2 Second Law of Thermodynamics

The second law of thermodynamics may be expressed in many ways. A very general statement is that any spontaneous change will render a system and its surroundings closer to an ultimate state of equilibrium from which no further change can spontaneously occur. That is, any isolated system left unattended will change toward a condition of maximum probability. In order to obtain a quantitative measure of the probability or randomness

of a system, the concept of entropy has been established.

The absolute entropy  $S$  of a substance in a particular state—under specified conditions of temperature, volume and pressure and in a known state of aggregation; solid, liquid, or gas—is proportional to the logarithm of the probability of finding the substance in that state.

$$S = k \ln W \quad (3-35)$$

where  $k$  is Boltzmann's constant, and  $W$  is the probability.

Entropy, like internal energy, depends only on the initial and final states of a system and, for an infinitesimal reversible process, is defined by the equation:

$$dS = \frac{dq(\text{rev})}{T} \quad (3-36)$$

where  $dq(\text{rev})$  is the heat absorbed from the surroundings in a reversible process, i.e., a process carried out in such a manner that it could be reversed by an infinitesimal change in external conditions. Entropy has the same units as heat capacity, i.e., calories per gram-atom per degree-Kelvin.

By using entropy, the second law can be expressed mathematically:

$$\Delta S_{\text{system}} + \Delta S_{\text{surroundings}} \geq 0 \quad (3-37)$$

Every spontaneous change in a system, therefore, is in a direction such that its entropy, plus that of its surroundings, increases. However, if the system alone is considered, spontaneity of chemical reactions may be treated by taking two driving forces into account; a tendency to adopt the lowest energy and a tendency to adopt the highest entropy. If the two changes are opposed, the system will proceed in the direction of the larger change. If the two quantities are exactly equal, no change will occur and the system is said to be at equilibrium. The net driving force is termed the Work Function or Helmholtz free energy  $A$ , and at constant temperature:<sup>15,16</sup>

$$\Delta A = \Delta E - T\Delta S \quad (3-38)$$

For a spontaneous process at constant volume and constant temperature,  $\Delta A$  is always negative:

$$(\Delta A)_{T,V} < 0 \quad (3-39)$$

For pyrotechnic reactions, many of which proceed at constant pressure and temperature, the Gibbs free energy  $F$  is a more useful function. The driving force or change in free energy is important and is expressed by:

$$\Delta F = \Delta H - T\Delta S \quad (3-40)$$

In this case, the criterion of spontaneity is:

$$(\Delta F)_{T,P} < 0 \quad (3-41)$$

As a consequence of Equations 3-38 and 3-40, additional statements may be made regarding the spontaneity of chemical reactions. These are summarized in Table 3-1.

At ordinary temperatures, entropy effects are small so they have little effect on the direction of a chemical reaction unless the difference in energy  $\Delta E$  or  $\Delta H$  between reactants and products is relatively small. At higher temperatures, such as those resulting from pyrotechnic reactions, the relative importance of the change in entropy increases until it becomes a dominant factor. Hence, all chemical reactions which involve an increase in entropy will occur spontaneously if the temperature is high enough. A discussion of free energy and the equilibrium constant is presented in Paragraph 3-2.3.

### 3-2.1.3 Third Law of Thermodynamics

According to the third law of thermodynamics, the entropy of a perfect crystalline substance at 0°K is zero. Although it is impossible theoretically to attain absolute zero, the validity of the third law has been checked by experimentation. It can also be shown that the entropies of all pure chemical compounds in their stable states at 0°K are zero because their formation from the elements is:  $\Delta S_f = 0$ . This law states that absolute entropies or so-called third law entropies can be determined from heat capacity data extrapolated to 0°K which can be used in equilibrium calculations:

$$S = \sum \left( \int_{T_0}^T C_p \frac{dT}{T} \right) + \sum \frac{\Delta H_{pc}}{T} \quad (3-42)$$

where  $\int_{T_0}^T C_p \frac{dT}{T}$ , the increase in entropy, is ob-

**TABLE 3-1**  
**CRITERIA OF SPONTANEITY**

<i>Conditions</i>	<i>Type of Reaction</i>	<i>Criteria</i>
General	Reversible	$\Delta S_{\text{total}} = 0$
	Spontaneous	$\Delta S_{\text{total}} > 0$
$E, v$ constant	Reversible	$\Delta S_{\text{isolated system}} = 0$
	Spontaneous	$\Delta S_{\text{isolated system}} > 0$
$T, v$ constant	Reversible	$\Delta A = 0$
	Spontaneous	$\Delta A < 0$
$T, p$ constant	Reversible	$\Delta F = 0$
	Spontaneous	$\Delta F < 0$
$S, v$ constant	Reversible	$\Delta E = 0$
	Spontaneous	$\Delta E < 0$
$S, p$ constant	Reversible	$\Delta G = 0$
	Spontaneous	$\Delta H < 0$

tained for each phase by graphical integration and  $\frac{\Delta H_{pc}}{T}$ , the entropy increase due to a phase change, is determined for each of the phase changes. The Debye Equation (Paragraph 3-2.1.1.2.2) is used for the temperature range 0°K to approximately 50°K as experimental data are difficult to obtain in this temperature range. Absolute entropies can also be calculated by the method of statistical mechanics.')

### 3-2.2 THERMOCHEMISTRY

Thermochemistry is the study of the heat effects accompanying chemical reactions, the formation of solutions, and changes in state such as fusion and vaporization. Since the amount of heat liberated from a pyrotechnic reaction strongly influences the characteristic output, an understanding of the principles and application of thermochemistry is of vital importance.

The heat evolved (or absorbed) in a chemical reaction depends upon :

1. The properties of the products and reactants, and the amount of these substances involved.
2. The physical state of the substances involved.
3. The temperature and pressure at which the reaction takes place.

4. Whether or not the reaction is at constant volume or constant pressure.

The specific influence of these conditions is described in the paragraphs which follow.

#### 3-2.2.1 Heats of Reaction

The heat effect associated with a pyrotechnic or other chemical reaction is the *heat of reaction*. The *heat of formation* is the heat of the reaction associated with the formation of a compound from its elements. The *heat of combustion* is the heat of the reaction associated with the complete combustion of a substance in oxygen. The *heat of explosion* is the heat of reaction associated with the rapid explosive decomposition of a material in an inert atmosphere.

For pyrotechnic reactions at constant pressure, if only pressure-volume **work** is considered, the heat effect  $q_p$  can be obtained from the enthalpy change for the reaction as follows:

$$q_p = \Delta H (\text{reaction}) = \Sigma H (\text{products}) - \Sigma H (\text{reactants}) \quad (3-40)$$

If the reaction is a standard state reaction, where the reactants in their standard states react to give the products in their standard states and the standard heats of formation  $\Delta H_T^\circ (f)$  of the elements is assumed to be zero at any given tem-

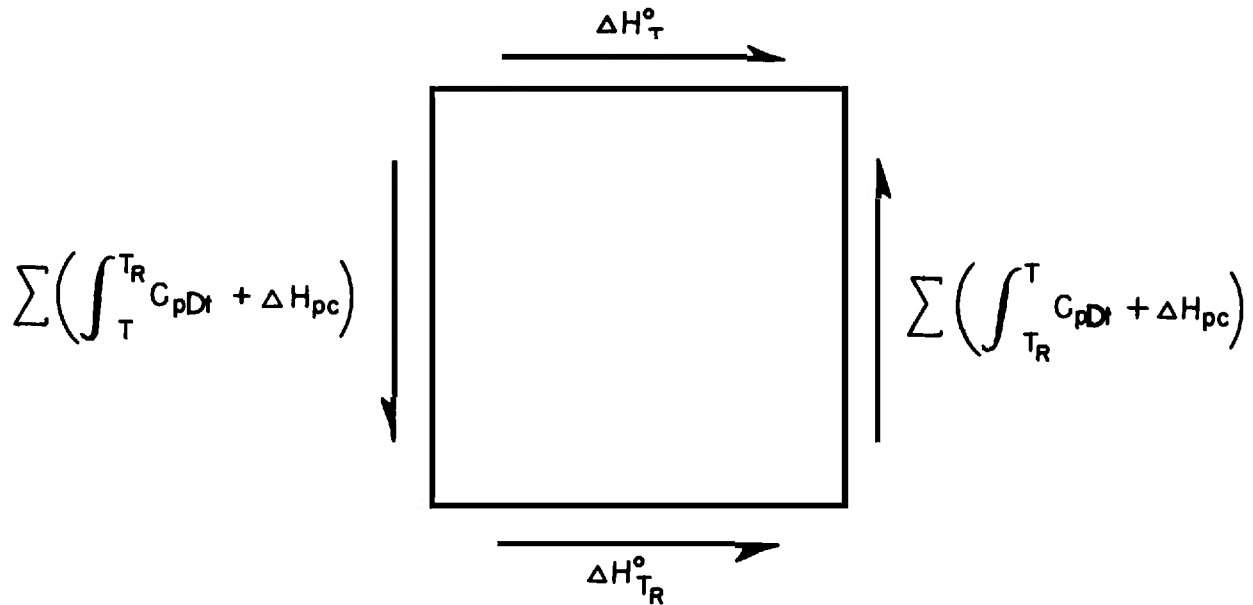

Figure 3-3. Effect of Temperature on Enthalpy Change for Chemical Reaction

perature, then the standard heat of reaction  $\Delta H_T^\circ$  (reaction) is :

$$\Delta H_T^\circ (\text{reaction}) = \sum AH(f)_{T^\circ} (\text{products}) - \sum \Delta H(f)_{T^\circ} (\text{reactants}) \quad (3-41)$$

The actual choice of standard states is somewhat arbitrary. Normally, the standard state is the most stable state at one atmosphere pressure and at the given temperature. (Most tabular data are given at 0°K or 298°K.)

Most thermochemical calculations are based on tabulated standard heats of formation. The heat effect at constant pressure ( $q_p$ ) can be calculated by :

$$(q_p)_T (\text{reaction}) = \Delta H_T (\text{reaction}) \cong \Delta H_{T^\circ} (\text{reaction}) \quad (3-45)$$

Unless the actual pressure is high, no appreciable error is introduced.

Similarly, the heat effect at constant volume ( $q_v$ ) can be obtained by :

$$\begin{aligned} (q_v)_T (\text{reaction}) &= \Delta E (\text{reaction}) \\ &\cong \Delta E_{T^\circ} (\text{reaction}) = \sum \Delta E(f)_{T^\circ} (\text{products}) \\ &\quad - \sum \Delta E(f)_{T^\circ} (\text{reactants}) \end{aligned} \quad (3-46)$$

### 3-2.2.2 Effect of Temperature on the Heat of Reaction

As illustrated schematically in Figure 3-3, the heat of reaction at any temperature  $T$  and constant pressure is :

$$\begin{aligned} \Delta H_T^\circ = \Delta H_{T_R}^\circ + \sum \left( \int_T^{T_R} C_p dT + AH_{,,} \right) (\text{reactants}) \\ + \sum \left( \int_{T_R}^T C_p dT + \Delta H_{pc} \right) (\text{products}) \end{aligned} \quad (3-47)$$

where  $\Delta H_T^\circ$  is the heat of reaction at temperature  $T$ ,  $\Delta H_{T_R}^\circ$  is the heat of reaction at a reference tem-

perature  $T_R$ ,  $\sum \left( \int_T^{T_R} C_p dT + AH_{,,} \right) (\text{reactants})$  is

the heat evolved or absorbed in cooling or heating the reactants from  $T$  to  $T_R$ , including that evolved or absorbed as a result of phase changes  $\Delta H_{pc}$ .

Similarly,  $\sum \left( \int_{T_R}^T C_p dT + \Delta H_{pc} \right) (\text{products})$  is the

heat absorbed or evolved in heating or cooling the products from  $T_R$  to  $T$ . According to Equation 3-47, if the heat evolved by cooling the reactants from the higher to the lower temperature is greater than the amount absorbed in heating the products from the lower to the higher temperature, the heat of reaction at the higher temperature will be greater than that at the lower temperature.

In cases where reactions begin and end at the same temperature and where no changes in phase are involved, the standard heat of reaction at temperature  $T$  is defined by:

$$\Delta H_{T^\circ} = \Delta H_{T_R^\circ} + \int_{T_R}^T \Delta C_p dT \quad (3-48)$$

where  $\Delta C_p = \sum C_p$  (products)  $- \sum C_p$  (reactants), and  $H_{T_R^\circ}$  is the standard heat of reaction at the reference temperature  $T_R$ . This is known as Kirchoff's Equation and, for small temperature ranges, heat capacities may be treated as constant and the equation reduces to:

$$\Delta H_{T^\circ} = \Delta H_{T_R^\circ} + \Delta C_p(T - T_R) \quad (3-49)$$

For other cases, experimental heat capacity data expressed in the form shown in Paragraph 3-2.1.1.2 must be used; however, if enthalpy tables are available, heat capacity data need not be considered as such.

Where data are required at temperatures above those listed, it may be necessary to extrapolate the data to the desired temperature,

### 3-2.2.3 Enthalpy Tables

Calculations of heat of reaction at different temperatures are simplified if tabular enthalpy data are available. Tables 3-2 for solid magnesium oxide, 3-3 for solid aluminum oxide, 3-4 and 3-5 for solid and liquid sodium oxide, and 3-6 for gaseous oxygen, contain these data. In these tables, standard heats of formation  $\Delta H_f^\circ$ , at different temperatures, are tabulated. In other tables only values for the enthalpy function,  $H^\circ - H_{T_R^\circ}$ , along with the heat of formation at some reference temperature, usually  $0^\circ\text{K}$  or  $298.93^\circ\text{K}$  are tabulated. The heat of reaction at any temperature becomes:

$$\Delta H_{T^\circ} = \Delta H_{T_R^\circ} + \sum (H^\circ - H_{T_R^\circ}) \text{ (products)} \\ - \sum (H^\circ - H_{T_R^\circ}) \text{ (reactants)} \quad (3-50)$$

These tables can also be used for calculations of free energy changes for chemical reactions. This is shown in Paragraph 3-2.3.5

### 3-2.2.4 Bond Energies<sup>7</sup>

Bond energy (B.E.) is defined as the average amount of energy per mole required to break a particular type of bond in a molecule. Bond energies may be calculated when heat of combustion data are available. However, of greater utility is the estimation of the heat of reaction from bond energy data for compounds for which no enthalpy data are available. In this case:

$$\Delta H = \text{B.E. (bonds broken)} - \text{B.E. (bonds formed)} \quad (3-51)$$

Bond strengths or bond dissociation energies may differ from mean bond energies derived solely from thermochemical data on molecules and atoms.

## 3-2.3 FREE ENERGY AND EQUILIBRIUM

A state of chemical equilibrium exists in any chemically reacting system when no further change in composition with time can be detected provided the temperature and pressure are not altered. The criterion of equilibrium is that the change in free energy of any possible reaction under these conditions shall be zero.

$$(\Delta F)_{T,P} = 0 \quad (3-52)$$

In order to estimate maximum flame temperatures from pyrotechnic reactions, a knowledge of the equilibrium concentrations of the combustion products is required in addition to information on the heat released. If a state of equilibrium exists among the product species, the equilibrium composition for the combustion products is fixed at a given temperature and pressure (or volume) when the atomic composition is specified.

Pyrotechnic reactions often involve the oxidation of a metal to form a refractory oxide. This reaction limits the maximum temperature attainable to the vaporization temperature of the metal oxide whether this oxide decomposes on vaporization, or not. The metals commonly used as fuels in pyrotechnics decompose on vaporization. In most cases, the metal decomposes to yield metal atoms; however, a few metal oxides, such as alum-

TABLE 3-2  
THERMODYNAMIC PROPERTIES OF SOLID MAGNESIUM OXIDE  
Magnesium Oxide (MgO) (Solid) Mol. Wt. = 28.32

T, °K.	cal. mole <sup>-1</sup> deg. <sup>-1</sup>			kcal. mole <sup>-1</sup>			Log K <sub>p</sub>
	C <sub>p</sub> <sup>o</sup>	S <sup>o</sup>	-(F <sup>o</sup> -H <sup>o</sup> <sub>298</sub> )/T	H <sup>o</sup> -H <sup>o</sup> <sub>298</sub>	ΔH <sup>o</sup> <sub>f</sub>	ΔF <sup>o</sup> <sub>f</sub>	
0	.000	.000	INFINITE	- 1.235	-142.702	-142.702	INFINITE
100	1.865	.608	12.488	- 1.188	-143.156	-140.918	307.961
200	6.380	3.369	7.184	- .763	-143.559	-138.501	151.340
298	8.906	6.439	6.439	.000	-143.700	-135.981	99.672
300	8.939	6.494	6.439	.017	-143.701	-135.933	99.022
400	10.148	9.252	6.807	.978	-143.705	-133.340	72.850
500	10.854	11.598	7.537	2.031	-143.654	-130.755	57.150
600	11.323	13.621	8.386	3.141	-143.583	-128.181	46.688
700	11.656	15.393	9.263	4.291	-143.513	-125.619	39.218
800	11.905	16.966	10.130	5.469	-143.457	-123.067	33.619
900	12.098	18.380	10.969	6.670	-143.425	-120.521	29.265
1000	12.251	19.663	11.775	7.888	-143.541	-117.799	25.744
1100	12.375	20.837	12.546	9.119	-143.529	-115.025	22.852
1200	12.478	21.918	13.283	10.362	-143.538	-112.252	20.443
1300	12.565	22.920	13.986	11.614	-143.567	-109.478	18.404
1400	12.638	23.854	14.658	12.874	-143.607	-106.235	16.583
1500	12.701	24.728	15.301	14.141	-143.712	-101.261	14.753
1600	12.756	25.550	15.916	15.414	-143.875	- 96.309	13.155
1700	12.804	26.325	16.505	16.692	-144.094	- 91.378	11.747
1800	12.845	27.058	17.071	17.975	-144.363	- 86.467	10.498
1900	12.882	27.753	17.616	19.261	-144.681	- 81.574	9.383
2000	12.915	28.415	18.139	20.551	-145.058	- 76.699	8.381
2100	12.945	29.046	18.644	21.844	-145.495	- 71.844	7.477
2200	12.971	29.648	19.130	23.140	-145.991	- 67.004	6.656
2300	12.994	30.225	19.600	24.438	-146.547	- 62.178	5.908
2400	13.016	30.779	20.054	25.739	-147.163	- 57.368	5.224
2500	13.035	31.311	20.494	27.041	-147.840	- 52.572	4.596
2600	13.052	31.822	20.920	28.346	-148.577	- 47.790	4.017
2700	13.068	32.315	21.333	29.652	-149.375	- 43.018	3.482
2800	13.082	32.791	21.734	30.959	-150.233	- 38.264	2.986
2900	13.095	33.250	22.123	32.268	-151.151	- 33.518	2.526
3000	13.107	33.694	22.501	33.578	-152.130	- 28.785	2.097

(JANAF Thermodynamic Tables, Interim Table Issued December 31, 1960)

inimum oxide, decompose to yield a mixture of other oxide molecules. Typical of the decomposition reaction is the following general reaction?



where  $M$  represents a metal element. Since the reactions are reversible, the degree of decomposition will depend on the oxygen partial pressure as well as the temperature. At the high temperatures produced by pyrotechnic reactions, many other equilibria, such as the dissociations of gaseous products, relatively unimportant at lower temperatures, must be considered.

### 3-2.3.1 Chemical Equilibrium

According to the law of mass action as stated by C. M. Guldberg and P. Waage,<sup>9</sup> the rate of a

chemical reaction is directly proportional to the "active masses" of the reacting materials. For any chemical reaction:

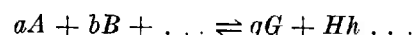

where the capital letter indicates a chemical species and the small letter indicates the number of moles of each species.

An equilibrium constant for this reaction, designated  $K$ , can be written in terms of concentrations:

$$K = \frac{k(f)}{k(r)} = \frac{[G]^g [H]^h}{[A]^a [B]^b} \quad (3-54)$$

where the open brackets [ ] indicate a concentration term,  $k(f)$  is the specific rate constant for the forward reaction,  $k(r)$  is the specific rate constant

TABLE 3-3  
THERMODYNAMIC PROPERTIES OF SOLID ALUMINUM OXIDE  
Aluminum Oxide (alpha  $\text{Al}_2\text{O}_3$ ) (Crystal) Mol. Wt. = 101.960

$T, ^\circ\text{K.}$	$C_p^\circ$	cal. mole <sup>-1</sup> deg. <sup>-1</sup> $S^\circ$	$-(F^\circ - H^\circ_{298})/T$	$H^\circ - H^\circ_{298}$	kcal. mole <sup>-1</sup> $\Delta H^\circ_f$	$\Delta F^\circ_f$	Log $K_p$
0	.000	.000	INFINITE	- 2.394	-397.494	-397.494	INFINITE
100	3.069	1.024	24.184	- 2.316	-398.697	-392.241	857.201
200	12.223	5.946	13.711	- 1.553	-399.838	-385.329	421.047
298	18.889	12.174	12.174	.000	-400.400	-378.078	277.125
300	18.979	12.291	12.174	.085	-400.406	-377.940	275.316
400	22.986	18.339	12.972	2.147	-400.555	-370.418	202.378
500	25.345	23.752	14.598	4.577	-400.475	-362.891	158.612
600	26.889	28.517	16.529	7.193	-400.304	-365.389	129.444
700	27.969	32.749	18.549	9.940	-400.098	-347.920	108.620
800	28.758	36.537	20.565	12.778	-399.889	-340.481	93.011
900	29.354	39.961	22.533	15.685	-399.697	-333.066	80.875
1000	29.814	43.078	24.434	18.644	-404.522	-325.301	71.091
1100	30.176	45.938	26.261	21.644	-404.181	-317.396	63.058
1200	30.464	48.574	28.012	24.674	-403.823	-309.522	56.369
1300	30.995	51.032	29.689	27.745	-403.437	-301.680	50.715
1400	31.290	53.339	31.297	30.859	-403.019	-293.868	45.873
1500	31.620	55.509	32.839	34.004	-402.581	-286.086	41.681
1600	31.920	57.559	34.321	37.181	-402.119	-278.334	38.017
1700	32.220	59.503	35.745	40.388	-401.635	-270.612	34.788
1800	32.490	61.353	37.117	43.624	-401.133	-262.920	31.921
1900	32.760	63.116	38.439	46.886	-400.613	-255.254	29.359
2000	33.000	64.803	39.716	50.175	-400.075	-247.619	27.057
2100	33.220	66.419	40.949	53.486	-399.521	-240.011	24.977
2200	33.450	67.969	42.142	56.819	-398.956	-232.427	23.088
2300	33.670	69.461	43.298	60.175	-398.374	-224.872	21.367
2400	33.880	70.898	44.418	63.553	-397.779	-217.339	19.790
2500	34.100	72.286	45.505	66.952	-397.172	-209.834	18.343
2600	34.310	73.627	46.561	70.372	-396.550	-202.354	17.009
2700	34.520	74.926	47.588	73.814	-395.915	-194.898	15.775
2800	34.735	76.186	48.587	77.277	-395.375	-187.457	14.573
2900	34.940	77.408	49.560	80.760	-395.307	-179.998	13.431
3000	35.140	78.596	50.508	84.264	-395.227	-172.522	12.338
3100	35.340	79.751	51.433	87.788	-395.132	-165.034	11.284
3200	35.530	80.876	52.335	91.332	-395.028	-157.528	10.271
3300	35.720	81.973	53.217	94.894	-394.908	-150.008	9.291
3400	35.906	83.042	54.078	98.476	-394.777	-142.476	8.341
3500	36.095	84.085	54.921	102.076	-394.634	-134.928	7.421

(JANAF Thermodynamic Tables, Interim Table Issued March 31, 1964)

for the reverse reaction, and  $K$  is the equilibrium constant. The concentration can be expressed as a partial pressure or as a mole fraction in addition to the more common concentration units. For actual systems, activities or fugacities should be used instead of concentrations.<sup>5,9</sup>

When more than one phase is present, as is true for most pyrotechnic reactions, the equilibrium is heterogeneous. Since the partial pressures of the gas phases in equilibrium with the solid phases are constant at a given temperature, they can be assumed to be incorporated into the equilibrium con-

stant. The expression in terms of partial pressures for the equilibrium constant, therefore, will include only terms for the gaseous materials.

The equilibrium between phases is an important type of heterogeneous equilibrium. The free energies of the vapor and liquid phases are the same which leads to the derivation of the important Clausius-Clapeyron Equation:<sup>9</sup>

$$\frac{dp}{dT} = \frac{p\Delta H}{RT^2} \quad (3-55)$$

In this equation,  $p$  is the vapor pressure in milli-

TABLE 3-4  
THERMODYNAMIC PROPERTIES OF SOLID SODIUM OXIDE  
Sodium Oxide (Na<sub>2</sub>O) (Crystal) Mol. Wt. = 61.982

T, °K.	cal. mole <sup>-1</sup> deg. <sup>-1</sup>			kcal. mole <sup>-1</sup>			Log K <sub>p</sub>
	C <sub>p</sub> <sup>o</sup>	S <sup>o</sup>	-(F <sup>o</sup> -H <sup>o</sup> <sub>298</sub> )/T	H <sup>o</sup> -H <sup>o</sup> <sub>298</sub>	ΔH <sup>o</sup> <sub>f</sub>	ΔF <sup>o</sup> <sub>f</sub>	
0							
100							
200							
298	17.436	17.990	17.990	.000	- 99.400	-90.125	66.060
300	17.454	18.098	17.990	.032	- 99.398	-90.067	65.610
400	18.442	23.254	18.687	1.827	-100.647	-86.862	47.457
500	19.430	27.475	20.034	3.720	-100.601	-83.417	36.460
600	20.418	31.105	21.584	5.713	-100.428	-79.995	29.137
700	21.406	34.327	23.178	7.804	-100.138	-76.612	23.918
800	22.394	37.249	24.757	9.994	- 99.737	-73.277	20.017
900	23.382	39.944	26.297	12.283	- 99.235	-69.998	16.997
1000	24.370	42.459	27.788	14.670	- 98.641	-66.780	14.594
1100	25.358	44.828	29.231	17.157	- 97.966	-63.629	12.641
1200	26.346	47.077	30.625	19.742	-143.685	-59.625	10.859
1300	27.334	49.224	31.974	22.426	-142.423	-52.670	8.854
1400	28.322	51.286	33.280	25.209	-141.067	45.817	7.152
1500	29.310	53.274	34.547	28.090	-139.615	-39.064	5.691
1600	30.298	55.197	35.778	31.071	-138.067	-32.409	4.427
1700	31.286	57.064	36.975	34.150	-136.420	-25.854	3.324
1800	32.274	58.880	38.142	37.328	-134.681	-19.401	2.355
1900	33.262	60.651	39.280	40.605	-132.846	-13.044	1.500
2000	34.250	62.382	40.392	43.980	-130.916	-6.791	.742

(JANAF Thermodynamic Tables, Interim Table Issued June 30, 1962)

meters of mercury,  $T$  is the absolute temperature,  $R$  is the universal gas constant, and  $\Delta H$  is the heat of vaporization in calories per gram-mole. If  $\Delta H$  can be considered constant over the temperature range of interest, then:

$$\log p = \left( \frac{-\Delta H}{2.3R} \right) \left( \frac{1}{T} \right) + \text{Constant} \quad (3-56)$$

This equation is of the same form as the empirical equation given in paragraph 3-1.2.1 relating change in vapor pressure and temperature. An equation of similar form relates the sublimation pressure and temperature.

The heterogeneous metal oxide decomposition equilibrium illustrated by Equation 3-53 is important to the study of pyrotechnic reactions. The expansion for the equilibrium constant for this reaction in terms of partial pressures  $K_p$  can be written:

$$K_p = (p_{O_2})^{1/2} (p_M)^x \quad (3-57)$$

where  $p_{O_2}$  is the partial pressure of the oxygen and  $p_M$  is the partial pressure of the metal vapor.

### 3-2.3.2 The LeChatelier Principle

The LeChatelier principle states that if a stress is brought to bear on a system in equilibrium the system will adjust itself to diminish the applied stress. For example, in the decomposition of a metal oxide in a confined system, the partial pressures will increase and the reaction shifts to the left. A higher temperature is required to decompose the oxide.

When heat is absorbed by a chemical reaction, an increase in temperature favors the reaction; on the other hand, if heat is evolved by the reaction, an increase in temperature will favor the reverse reaction.

### 3-2.3.3 Free Energy and the Equilibrium Constant

For any chemical reaction the change in free energy is given by

$$\Delta F = RT \ln \frac{Q}{K} \quad (3-58)$$

where  $K$  is the equilibrium constant.  $Q$  is a continuous function similar in form to  $K$  (Equation



TABLE 3-5  
THERMODYNAMIC PROPERTIES OF LIQUID SODIUM OXIDE  
Sodium Oxide (Na<sub>2</sub>O) (Liquid) Mol. Wt. = 61.982

T, °K.	cal. mole <sup>-1</sup> deg. <sup>-1</sup>			kcal. mole <sup>-1</sup>			Log K <sub>p</sub>
	C <sub>p</sub> <sup>o</sup>	S <sup>o</sup>	-(F <sup>o</sup> -H <sup>o</sup> <sub>298</sub> )/T	H <sup>o</sup> -H <sup>o</sup> <sub>298</sub>	ΔH <sup>o</sup> <sub>f</sub>	ΔF <sup>o</sup> <sub>f</sub>	
0							
100							
200							
298	27.000	17.889	17.889	.000	-93.996	-84.691	62.077
300	27.000	18.056	17.890	.050	-93.977	-84.632	61.652
400	27.000	25.823	18.949	2.750	-94.320	-81.562	44.561
500	27.000	31.848	20.948	5.450	-93.468	-78.470	34.298
600	27.000	36.771	23.188	8.150	-92.587	-75.553	27.519
700	27.000	40.933	25.433	10.850	-91.688	-72.787	22.724
800	27.000	44.538	27.601	13.550	-90.777	-70.148	19.163
900	27.000	47.719	29.663	16.250	-89.864	-67.624	16.421
1000	27m	50.563	31.613	18.950	-88.958	-65.201	14.249
1100	27.000	53.137	33.455	21.650	-88.069	-62.872	12.491
1200	27.000	55.486	35.194	24.350	-133.673	-59.704	10.873
1300	27m	57.647	36.839	27.050	-132.396	-53.592	9.009
1400	27.000	59.648	38.398	29.750	-131.122	-47.579	7.427
1500	27m	61.511	39.878	32.450	-129.851	-41.655	6.069
1600	27m	63.253	41.285	35.150	-128.584	-35.816	4.892
1700	27.000	64.890	42.626	37.850	-127.317	-30.056	3.864
1800	27m	66.433	43.906	40.550	-126.055	-24.371	2.959
1900	27.000	67.893	45.130	43.250	-124.797	-18.755	2.157
2000	27m	69.278	46.303	45.950	-123.543	-13.209	1.443
2100	27.000	70.596	47.429	48.650	-122.289	-7.725	.804
2200	27.000	71.852	48.511	51.350	-121.041	-2.297	.228
2300	27.000	73.052	49.552	54.050	-119.795	3.070	-.292
2400	27.000	74.201	50.555	56.750	-118.554	8.390	-.764
2500	27.000	75.303	51.523	59.450	-117.316	13.649	-1.193
2600	27.000	76.362	52.458	62.150	-116.084	18.866	-1.586
2700	27m	77.381	53.362	64.850	-114.857	24.031	-1.945
2800	27.000	78.363	54.238	67.550	-113.637	29.151	-2.275
2900	27.000	79.310	55.086	70.250	-112.421	34.234	-2.580
3000	27.000	80.226	55.909	72.950	-111.213	39.269	-2.861

(JANAF Thermodynamic Tables, Interim Table Issued June 30, 1962)

3-54) but which applies to the "concentrations" or partial pressures of the products and reactants at any time during a particular reaction. For real gases and other substances, the  $K$  and  $Q$  should be terms of activities or fugacities. If the reaction is a standard state reaction, the hypothetical reaction in which the reactants in their standard states at one atmosphere react to give products in their standard states at one atmosphere,  $Q$  becomes unity and

$$\Delta F^{\circ} = -RT \ln K \quad (3-59)$$

For a gaseous reaction involving gases which can be considered ideal:

$$\Delta F^{\circ} = -RT \ln K, \quad (3-60)$$

where  $K$ , is the equilibrium constant in terms of

partial pressures. For example, the equilibrium constant for the decomposition of a metal oxide, Equation 3-57 is related to the standard free energy change for the reaction, Equation 3-59, as follows:

$$\Delta F^{\circ} = -RT \ln K, = -RT \ln (p_{O_2(g)})^{y/2} (p_{M(g)})^x \quad (3-61)$$

where  $p_{O_2}$  is the partial pressure of the oxygen and  $p_M$  is the partial pressure of the metal vapor. Hence, the stability of the oxide can be calculated from frequency data.

### 3-2.3.4 Free Energy Calculations

Standard free energy changes for chemical reac-

**TABLE 3-6**  
**THERMODYNAMIC PROPERTIES OF OXYGEN**  
 Oxygen, Diatomic (O<sub>2</sub>) (Reference State—Ideal Gas) Mol. Wt. = 32.00

T, °K.	cal. mole <sup>-1</sup> deg. <sup>-1</sup>			kcal. mole <sup>-1</sup>			Log K <sub>p</sub>
	C <sub>p</sub> <sup>o</sup>	S <sup>o</sup>	-(F <sup>o</sup> -H <sup>o</sup> <sub>298</sub> )/T	H <sup>o</sup> -H <sup>o</sup> <sub>298</sub>	ΔH <sup>o</sup> <sub>f</sub>	ΔF <sup>o</sup> <sub>f</sub>	
0	.000	.000	INFINITE	- 2.075	.000	.000	.000
100	6.741	41.522	55.142	- 1.362	.000	.000	.000
200	6.871	46.233	49.641	- .682	.000	.000	.000
298	7.020	49.004	49.004	.000	.000	.000	.000
300	7.023	49.047	49.004	.013	.000	.000	.000
400	7.196	51.091	49.282	.724	.000	.000	.000
500	7.431	52.722	49.812	1.455	.000	.000	.000
600	7.670	54.098	50.414	2.210	.000	.000	.000
700	7.883	55.297	51.028	2.988	.000	.000	.000
800	8.063	56.361	51.629	3.786	.000	.000	.000
900	8.212	57.320	52.209	4.600	.000	.000	.000
1000	8.336	58.192	52.765	5.427	.000	.000	.000
1100	8.439	58.991	53.295	6.266	.000	.000	.000
1200	8.527	59.729	53.801	7.114	.000	.000	.000
1300	8.604	60.415	54.283	7.971	.000	.000	.000
1400	8.674	61.055	54.744	8.835	.000	.000	.000
1500	8.738	61.656	55.185	9.706	.000	.000	.000
1600	8.800	62.222	55.608	10.583	.000	.000	.000
1700	8.858	62.757	56.013	11.465	.000	.000	.000
1800	8.916	63.265	56.401	12.354	.000	.000	.000
1900	8.973	63.749	56.776	13.249	.000	.000	.000
2000	9.029	64.210	57.136	14.149	.000	.000	.000
2100	9.084	64.652	57.483	15.054	.000	.000	.000
2200	9.139	65.076	57.819	15.966	.000	.000	.000
2300	9.194	65.483	58.143	16.882	.000	.000	.000
2400	9.248	65.876	58.457	17.804	.000	.000	.000
2500	9.301	66.254	58.762	18.732	.000	.000	.000
2600	9.354	66.620	59.057	19.664	.900	.000	.000
2700	9.405	66.974	59.344	20.602	.000	.000	.000
2800	9.455	67.317	59.622	21.545	.000	.000	.000
2900	9.503	67.650	59.893	22.493	.000	.000	.000
3000	9.551	67.973	60.157	23.446	.000	.000	.000
3100	9.596	68.287	60.415	24.403	.000	.000	.000
3200	9.640	68.592	60.665	25.365	.000	.000	.000
3300	9.682	68.889	60.910	26.331	.000	.000	.000
3400	9.723	69.179	61.149	27.302	.000	.000	.000
3500	9.762	69.461	61.383	28.276	.000	.000	.000
3600	9.799	69.737	61.611	29.254	.000	.000	.000
3700	9.835	70.006	61.834	30.236	.000	.000	.000
3800	9.869	70.269	62.053	31.221	.000	.000	.000
3900	9.901	70.525	62.267	32.209	.000	.000	.000
4000	9.932	70.776	62.476	33.201	.000	.000	.000
4100	9.961	71.022	62.682	34.196	.000	.000	.000
4200	9.988	71.262	62.883	35.193	.000	.000	.000
4300	10.015	71.498	63.081	36.193	.000	.000	.000
4400	10.039	71.728	63.275	37.196	.000	.000	.000
4500	10.062	71.954	63.465	38.201	.000	.000	.000
4600	10.084	72.176	63.652	39.208	.000	.000	.000
4700	10.104	72.393	63.836	40.218	.000	.000	.000
4800	10.123	72.606	64.016	41.229	.000	.000	.000
4900	10.140	72.814	64.194	42.242	.000	.000	.000
5000	10.156	73.019	64.368	43.257	.000	.000	.000
5100	10.172	73.221	64.540	44.274	.000	.000	.000
5200	10.187	73.418	64.708	45.292	.000	.000	.000
5300	10.200	73.613	64.875	46.311	.000	.000	.000
5400	10.213	73.803	65.038	47.332	.000	.000	.000
5500	10.225	73.991	65.199	48.353	.000	.000	.000
5600	10.237	74.175	65.358	49.377	.000	.000	.000
5700	10.247	74.356	65.514	50.401	.000	.000	.000
5800	10.258	74.535	65.668	51.426	.000	.000	.000
5900	10.267	74.710	65.820	52.452	.000	.000	.000
6000	10.276	74.883	65.970	53.479	.000	.000	.000

(JANAF Thermodynamic Tables, Interim Table Issued March 31, 1961)

tions  $\Delta F_T^\circ$  can be calculated from the standard free energies of formation,  $\Delta F_T^\circ(f)$  :

$$\Delta F_T^\circ = \Sigma \Delta F_T^\circ(f) \text{ products} = \Sigma \Delta F_T^\circ(f) \text{ reactants} \quad (3-62)$$

Standard free energy of formation of the elements in their standard state at one atmosphere pressure and at the given temperature is taken as zero.

The standard free energy change and the associated equilibrium constant (Equation 3-58) are functions of temperature. The change in free energy, the enthalpy change  $\Delta H$ , and the temperature are related by the Gibbs Helmholtz equation which, for a standard state reaction, is:

$$\frac{\Delta H^\circ}{T} - \frac{\Delta F^\circ}{T} = -\frac{d\Delta F^\circ}{dT} = \frac{d(RT \ln K)}{dT} \quad (3-63)$$

If  $\Delta H^\circ$  can be considered constant over the range of temperature, or is an average value:

$$\frac{\Delta F^\circ}{RT} = -\log K_p = + \frac{\Delta H^\circ}{2.3RT} + \text{Constant} \quad (3-64)$$

If  $\Delta H^\circ$  cannot be treated as a constant over the temperature range, the calculation of the change in

the equilibrium constant with temperature is more complicated.

### 3-2.3.5 Tabulated Free Energy Values

Calculations involving free energy changes at any temperature are made easier if tabulated values are available for the standard free energy of formation at various temperatures. Tables 3-2, 3-3, 3-4, 3-5, and 3-6 contain this information in addition to the information on standard enthalpies of formation. In these particular tables, the standard free energies of formation of the compound from the elements in their standard states, along with the equilibrium constant for the formation reaction, are tabulated for various temperatures. In other tabulations the free energy function

$\frac{F_T^\circ - F_{T_R}^\circ}{T}$  is tabulated for various temperatures

along with the standard free energies of formation at some reference temperature, where  $T$  is the reaction temperature and  $T_R$  is the reference temperature.

Then:

$$\Delta F_T^\circ = \Sigma \Delta F_{T_R}^\circ(f) \text{ products} - \Sigma \Delta F_{T_R}^\circ(f) \text{ reactants} \quad (3-65)$$

$$+ \Sigma T \left( \frac{F_T^\circ - F_{T_R}^\circ}{T} \right) \text{ products} - \Sigma T \left( \frac{F_T^\circ - F_{T_R}^\circ}{T} \right) \text{ reactants}$$

The reference temperatures normally used are 298°K or 0°K. The free energy change at these

two temperatures is related by:

$$\Delta F_{298}^\circ = \Sigma \Delta H^\circ(f) \text{ products} - \Sigma \Delta H^\circ(f) \text{ reactants} \quad (3-66)$$

$$+ \Sigma 298 \left( \frac{F_{298}^\circ - H^\circ}{298} \right) \text{ products} - \Sigma 298 \left( \frac{F_{298}^\circ - H^\circ}{298} \right) \text{ reactants}$$

### 3-2.4 ADIABATIC FLAME TEMPERATURE

The heat produced by an exothermic reaction raises the temperature of the products formed to the reaction temperature. This maximum temperature can be calculated from a knowledge of the equilibrium composition of the combustion products and of the energy released by the reaction. The

calculations assume adiabatic conditions, i.e., no heat is lost to or gained from the surroundings, and all the heat released is utilized in raising the temperature of the products and unreacted reactants to the flame temperature. At constant pressure, where the heat effect associated with a given reaction is equal to its enthalpy change:

$$\Delta H_T^\circ = \Delta H_{T_R}^\circ(\text{reaction}) + \Sigma \Delta H(\text{diss}) + \Sigma \Delta H_{p_c} + \Sigma \int_{T_R}^{T_1} C_p(\text{products}) dT \quad (3-67)$$

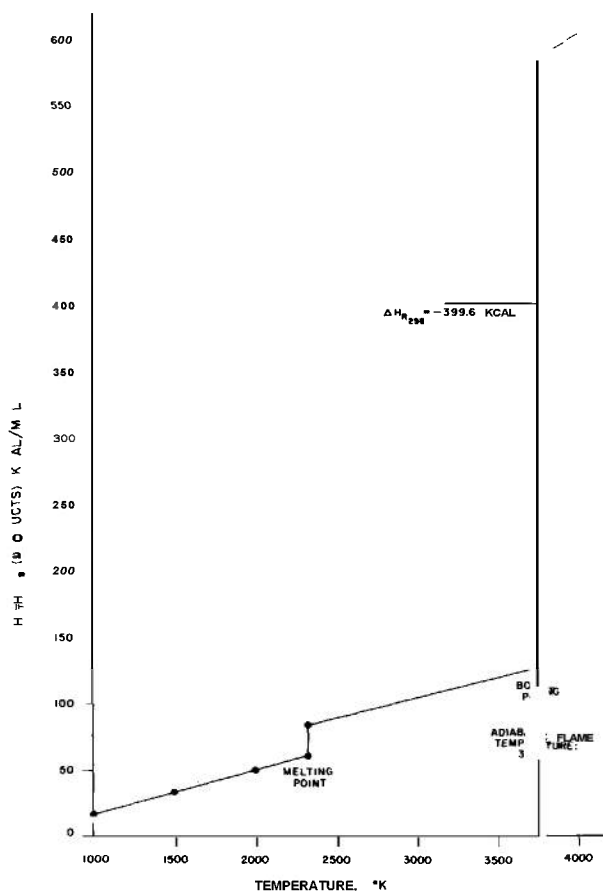

Figure 3-4. Enthalpy of Aluminum Oxide Versus Temperature

where  $\Delta H_{T_R}^\circ$  is the enthalpy change for the reaction at a reference temperature  $T_R$ ;  $\Sigma \Delta H$  (diss) is the summation of the enthalpy changes associated with the dissociation of gaseous products and with ionization if the flame temperatures are sufficiently high;  $\Sigma \Delta H_{pc}$  is the summation of the enthalpy changes associated with phase changes in the reac-

tion products; and  $\Sigma \int_{T_R}^{T_T} C_p$  (products)  $dT$  is the amount of heat necessary to raise the reaction products to the flame temperature.

Before calculating the enthalpy change for the reaction, equations must be obtained for the molar

composition of the combustion products allowing for all elements and equilibrium relationships.<sup>10</sup> The calculation of the adiabatic flame temperature is an iterative process for which use of a high speed computer is recommended.

For simpler cases, where the number of product species is small, the flame temperature can be calculated by a trial and error process until a temperature is found at which all the energy released by the chemical reaction will be absorbed.

The calculation of the adiabatic temperature for some chemical reactions, including those involving the oxidation of metals, can be simplified by preparing an enthalpy or heat-content graph. This graph consists of a plot of the heat content (above the selected reference temperature for the reaction products) as a function of temperature, using tabulated values for  $H_{T^\circ} - H_{T_R}^\circ$ ;  $H_{T^\circ} - H^\circ$  or heat capacity; heat of fusion; heat of vaporization; and heat of dissociation. The heat of reaction is located on the ordinate of the plot and the horizontal line is drawn from this value until it intersects the heat content curve.<sup>11</sup> The adiabatic flame temperature is read from the abscissa.

### 3-2.5 SAMPLE THERMODYNAMIC CALCULATIONS

The following sample calculations have been selected to illustrate the application of thermodynamics to pyrotechnic reactions.

**Example 1.** The adiabatic flame temperature for aluminum burning in a stoichiometric amount of oxygen can be calculated as follows. The overall stoichiometric reaction is :

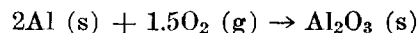

The heat of reaction at 298°K is the same as the heat of formation of  $\text{Al}_2\text{O}_3$  (s)  $\sim$  400 kilocalories per mole. (See paragraph 3-2.2.) The heat content plot for this reaction is given in Figure 3-4 where the reference temperature is taken as 298°K.

Approximately 400 kilocalories are released in the formation of solid aluminum oxide at the reference temperature of 298°K. As shown in Figure 3-4, approximately 140 kilocalories of this energy are required to raise one mole of aluminum oxide to its boiling point. The difference (400 to 140 kilocalories) is consumed in vaporization of the

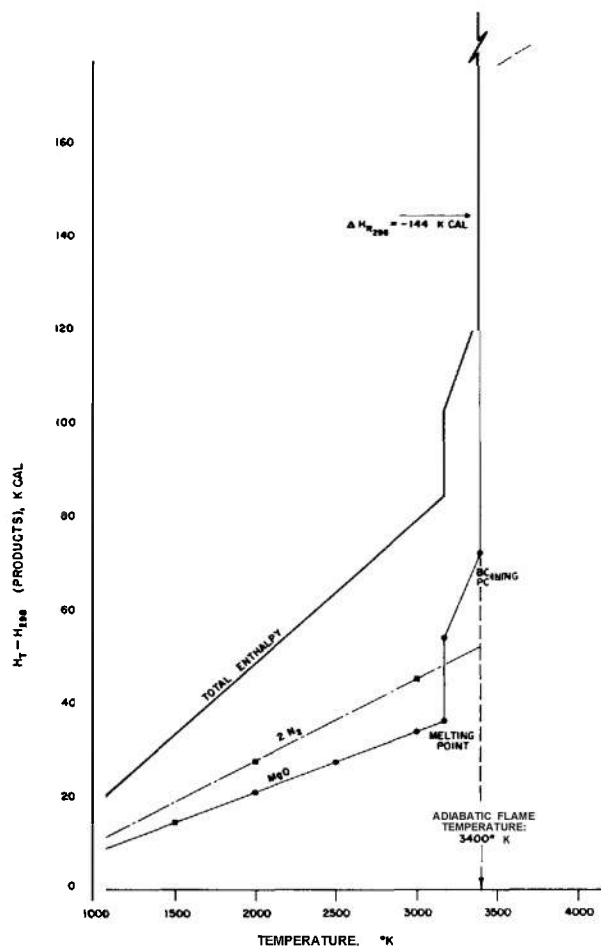

Figure 3-5. Enthalpy of Products of Magnesium-Air Reaction

liquid aluminum oxide. The vaporization of  $\text{Al}_2\text{O}_3$  (l) at approximately 3800°K may take place as follows:



For this reaction, the standard enthalpy change is:

$$H^\circ_{298^\circ\text{K}} = 456 \text{ kilocalories per mole}$$

As there is not enough energy available to vaporize all the aluminum oxide, the maximum temperature is limited to the boiling point of aluminum oxide, or approximately 3800°K.

$$\Delta H^\circ_{298} = [5(-143.8) + -99.41 - [5(0) + 2(-115.0)]] = -588.4 \text{ kilocalories}$$

and for the second reaction is:

$$\Delta H^\circ_{298} = [6(-143.8) + 2(0)] - [6(0) + 2(-115.0)] = -632.8 \text{ kilocalories}$$

**Example 2.** The adiabatic flame temperature for magnesium burning in air (20% oxygen, 80% nitrogen) can be calculated in a similar manner. The reaction, in this case is:

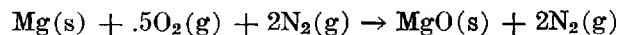

The heat of reaction at the reference temperature of 298°K is the heat of formation of  $\text{MgO}(s)$ , or 144 kilocalories per mole. Figure 3-5 is a heat content plot for the products of this reaction where it is assumed that magnesium oxide vaporizes by dissociation into atoms. It must be noted that the nitrogen in the air must be heated to the flame temperature. The adiabatic flame temperature is limited to the boiling point of magnesium oxide, about 3400°K. If the magnesium were burned in pure oxygen, the calculated adiabatic flame temperature would still be limited to about 3400°K.

**Example 3.** Compositions containing magnesium and sodium nitrate are used in many illuminating flares. There are several possible ways for this reaction to proceed which, in turn, determine relative amounts of magnesium and sodium nitrate required for the stoichiometric (balanced) chemical reaction. Two of the possible stoichiometric reactions are:

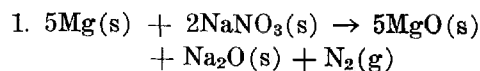

and:

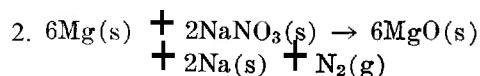

For the first reaction, the ratio of the weight of sodium nitrate required to weight of magnesium is:

$$\frac{2(85)}{5(24.3)} = 1.40$$

and for the second reaction is:

$$\frac{2(85)}{6(24.3)} = 1.166$$

The heat of reaction for the first reaction at 298°K is:

From the heat content plots for the two reactions, Figures 3-6 and 3-7, the adiabatic flame temperature is nearly the same for both reactions: approximately 3280°K for the first reaction, and 3400°K (the boiling point of magnesium oxide) for the second reaction.

The reaction equation which best represents the reaction to produce the products which exist

$$\Delta H^{\circ}_{2500^{\circ}\text{K}} = [2(0) + .5(0)] - [1(+13.649)] = -13.649 \text{ kilocalories}$$

and by Equation 3-64 (Paragraph 3-2.3.4)

$$-13.649 = \frac{-(2)(2.3)(2500) \log K_p}{1000}$$

$$K_p = 15.4$$

Also:  $K_p = (P_{Na})^2 \cdot (P_{O_2})^{1/2} = (4P_{O_2})^2 \cdot (P_{O_2})^{1/2}$

$$\text{and: } (P_{O_2}) = .746 \text{ atm}$$

Since the calculated  $(P_{O_2})$  is greater than the partial pressure of oxygen in the air, 0.2 atmosphere, the compound  $\text{Na}_2\text{O}$  (1) is not thermodynamically stable at 2500°K. Therefore, these calculations indicate that the second reaction better represents the stoichiometry of the overall reaction leading to the formation of the product species present at a flame temperature of 2500°K.

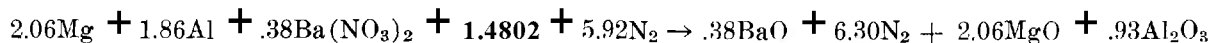

The heat of reaction at 298°K is:

$$\Delta H^{\circ}_{298} = [.38(-133.5) + 6.3(0) + 2.06(-143.7) + .93(-400.4)]$$

$$- [2.06(0) + 1.86(0) + .38(-237.06) + 1.48(0) + 5.92(0)] = 628.6 \text{ kilocalories}$$

The heat content diagram for this system is shown in Figure 3-8. As indicated on this diagram, the adiabatic flame temperature is approximately 3400°K.

Less heat is evolved if it is assumed that oxygen from the air is not available for the reaction.

*Example 5.* The optimum composition for a magnesium-sodium nitrate illuminating composi-

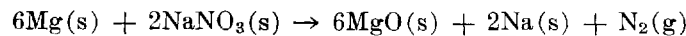

for which the heat of reaction  $\Delta H^{\circ}_{298}$  is 632.8 kilocalories. The number of moles of magnesium  $n$

in the hot (over 2500°K) portions of the flame plume can be selected from thermodynamic considerations in the following manner.

At 2500°K, the free energy change associated with the reaction:

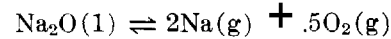

is given by Equation 3-62 (Paragraph 3-2.3.4).

However, the first reaction better represents the overall reaction to form the products which are stable at room temperature since similar calculations indicate that  $\text{Na}_2\text{O}(s)$  is the more stable sodium-containing species at room temperature.

*Example 4.* IM-11 is a widely used incendiary mixture. It consists of 50 percent magnesium-aluminum alloy (50/50) and 50 percent barium nitrate by weight. This mixture is fuel rich and if all the fuel is to burn, extra oxygen must be obtained from the air. If it is assumed that sufficient oxygen is available to oxidize the metal fuels, a balanced reaction can be written.

On a basis of 200 grams of IM-11, the moles of each constituent are:  $\text{Ba}(\text{NO}_3)_2$ ,  $100/261.4 = 0.38$ ;  $\text{Mg}$ ,  $50/24.32 = 2.06$ ;  $\text{Al}$ ,  $50/26.97 = 1.86$ . Accordingly, the reaction is:

tion, to be burned at low altitudes where oxygen is available from the atmosphere, can be estimated by assuming that the amount of magnesium in excess of the stoichiometric amount which can be vaporized by the stoichiometric reaction, based on the amount of sodium nitrate, can burn in the air. For the magnesium-sodium nitrate system the stoichiometric reaction is (see Example 3):

which could be vaporized by this amount of energy is:

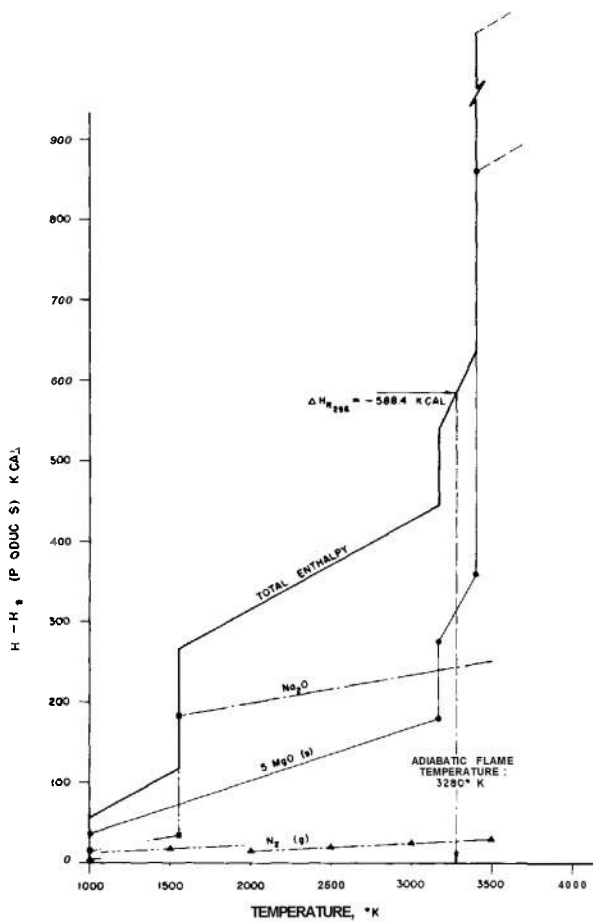

figure 3-6. Enthalpy of Products of Magnesium-Sodium Nitrate Flare (Reaction 1)

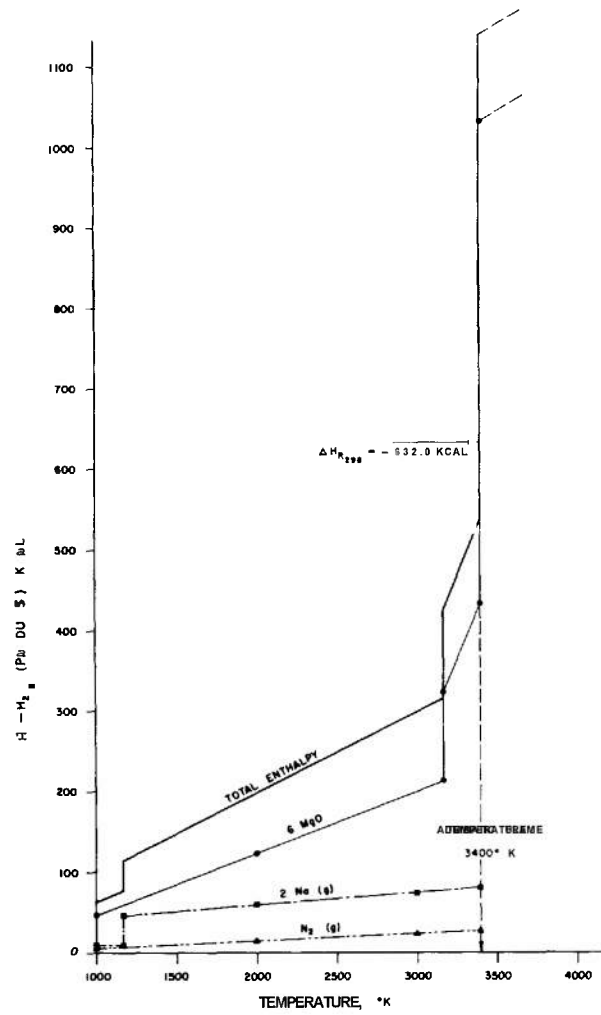

Figure 3-7. Enthalpy of Products of Magnesium-Sodium Nitrate Flare (Reaction 2)

$$n = \frac{\Delta H^{\circ}_{298}}{\Delta H[\text{Mg}(v)1390^{\circ}\text{K} - \text{Mg}(s)298^{\circ}\text{K}]} = \frac{632.8}{40.75} = 15.52 \text{ moles}$$

so that the weight percentage of magnesium for the optimum composition would be:

$$\frac{(6 + n) (MW \text{ Mg})}{(6 + n) (MW \text{ Mg}) + 2(MW \text{ NaNO}_3)} = \frac{(21.52) (24.3)}{(21.52) (24.3) + 2(85.01)} \times 100 = 75.5\%$$

where *MW* stands for the molecular weight.

### 3-2.6 SUMMARY OF THERMOCHEMICAL CALCULATIONS

Results of thermochemical calculations such as those illustrated in the foregoing examples, can be summarized as shown in Tables 3-7 and 3-8. All cal-

culations on these sheets are for a reference temperature 298.15°K and one atmosphere pressure.

### 3-3 CHEMICAL KINETICS

Chemical kinetics is concerned with the velocity of reactions and the intermediate steps (mechanisms) by which the reactants are ultimately

**TABLE 3-7**  
**EXAMPLE OF THERMOCHEMICAL CALCULATIONS:**  
**LANTHANUM-POTASSIUM PERCHLORATE REACTION**  
 THERMOCHEMICAL CALCULATIONS\*

	%	<i>Mol Wt</i>	$\Delta H_f$	<i>Density, g/ml</i>
<b>REACTANTS</b>				
Lanthanum (s)	72.6	138.92	0.	6.15
Potassium Perchlorate (s)	27.4	138.55	103.6	2.52
<b>PRODUCTS</b>				
Lanthanum Oxide (s)	85.5	325.84	458	6.51
Potassium Chloride (s)	14.5	74.56	104.2	1.99
<b>REACTION CALCULATIONS</b>				
	8La	+ 3KClO <sub>4</sub>	→ 4La <sub>2</sub> O <sub>3</sub>	+ 3KCl
Stoichiometric :	8(138.92)	+ 3(138.6)	→ 4(325.84)	+ 3( 74.56)
Thermal:	8(0)	+ 3(103.6)	→ 4(458)	+ 3(104.2)
Wt Reactants, g	1521.2			
Theoretical Density (calc.), g/ml	4.41			
Heat of Reaction (calc.), Keal	1834			
	cal/g 1205			
	cal/ml 5330			
Adiabatic Temp (calc.), °K	App. 4750			
Gas Volume (calc.), liters	0			
<b>EQUIVALENTS</b>				
1.0 g La	= 0.445 g KClO <sub>4</sub> = 1742 cal			
<b>1.0g</b> KClO <sub>4</sub>	<b>= 2.650 g La = 4400 cal</b>			
<b>THEORETICAL OPTIMUM COMPOSITION</b>				
Lanthanum, %	85			
Potassium Perchlorate, %	15			

\* All calculations refer to 298.15°K.

converted into the products. As most pyrotechnic reactions involve heterogeneous systems, the relatively simple kinetic equations developed for homogeneous systems are useful but not adequate. These equations do, however, provide background for understanding of the chemical kinetics involved in a heterogeneous reaction. It is to be noted that the rate of a pyrotechnic reaction, which is affected by external temperature, pressure confinement, composition, particle size, consolidation, and other interrelated factors, is usually best determined experimentally.

### 3-3.1 MOLECULARITY OF REACTIONS

The simple, intermediate reactions by which the reactants are ultimately converted into products can be classified as:

1. Unimolecular. A reaction in which only one molecule reacts to yield the product(s).
2. Bimolecular. A reaction in which two molecules (of the same or of different kinds) react to yield the product(s).
3. Termolecular. A reaction in which three molecules react to form the product(s).



**TABLE 3-8**  
**EXAMPLE OF THERMOCHEMICAL CALCULATIONS:**  
**ZIRCONIUM-OXYGEN REACTION**  
**THERMOCHEMICAL CALCULATIONS\***

	%	<i>Mol Wt</i>	$\Delta H_f$	<i>Density, g/ml</i>
<b>REACTANTS</b>				
Zirconium (s)	74.3	91.22	0	6.49
Oxygen (g)	25.7	32.0	0	
<b>PRODUCTS</b>				
Zirconium Oxide(s)	100	123.22	261.5	5.6
<b>REACTION CALCULATIONS</b>				
	Zr(s)	+ O <sub>2</sub> (g)	=	ZrO <sub>2</sub> (s)
Stoichiometric:	91.22	+ 32	→	123.22
Thermal: $\Delta H_r$	0	+ 0	→	261.5
Wt Reactants, gs		123.22		
Theoretical Density (calc.), g/ml		—		
Heat of reaction (calc.), Kcal		261.5		
		cal/g		2120
Adiabatic Temp (calc.), °K	App.	4500		
Gas Volume, liters/g		0		
<b>EQUIVALENTS</b>				
	One g Zr = 0.346 g O <sub>2</sub> = 2860 cal			
	One g O <sub>2</sub> = 2.89 g Zr = 8250 cal			

\* All calculations refer to 298.15°K.

(There are few, if any, termolecular reactions.)

The overall reactions occurring in the burning of a pyrotechnic composition consist of a sequence of many simple intermediate unimolecular, bimolecular and termolecular reactions.

### 3-3.2 ORDER OF REACTION

The instantaneous rate of a chemical reaction, as measured by the rate of disappearance of one of its reactants, can be written:

$$\frac{-dA}{dt} = k[A]^m [B]^n [C]^o \dots \quad (3-68)$$

where the minus sign indicates the disappearance of reactant *A*, the symbol [ ] indicates concentra-

tions, *k* is the specific rate constant, and the exponents *m*, *n*, and *o*, are empirically determined. For gaseous reactions, concentrations are often expressed in terms of partial pressures. Similar expressions could be written for the disappearance of other reactants or for the appearance of any of the products.

The overall order of the reaction is the sum of the exponents of the "concentration" terms. The order of a reaction, with respect to one reactant, is the exponent of the concentration term for that reactant. Examples are:

$$\text{Zero Order: } -\frac{d[A]}{dt} = k \quad (3-69)$$

The reaction rate is a constant and is independent of the concentration of the reactants.

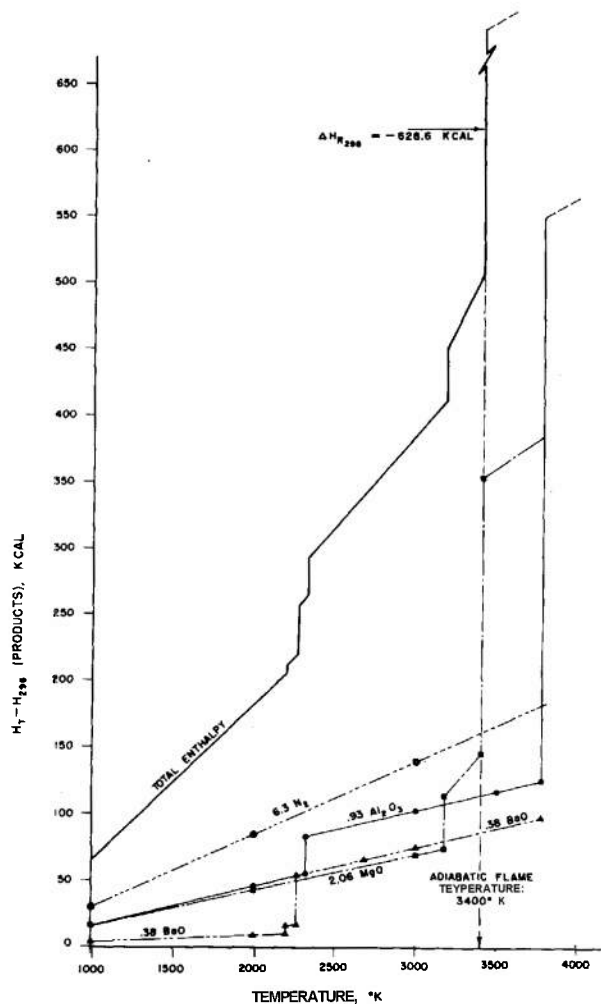

Figure 3-8. Enthalpy of IM-11 Incendiary Mixture

First Order:

$$-\frac{d[A]}{dt} = k[A] \quad (3-70)$$

The reaction rate is proportional to the concentration of a reactant. In this case, half-life (the time required for one-half of the reactant present at any given time to disappear) is independent of the initial concentration.

Second Order:

$$-\frac{d[A]}{dt} = k[A][B] \quad (3-71)$$

or:

$$-\frac{d[A]}{dt} = k[A]^2 \quad (3-72)$$

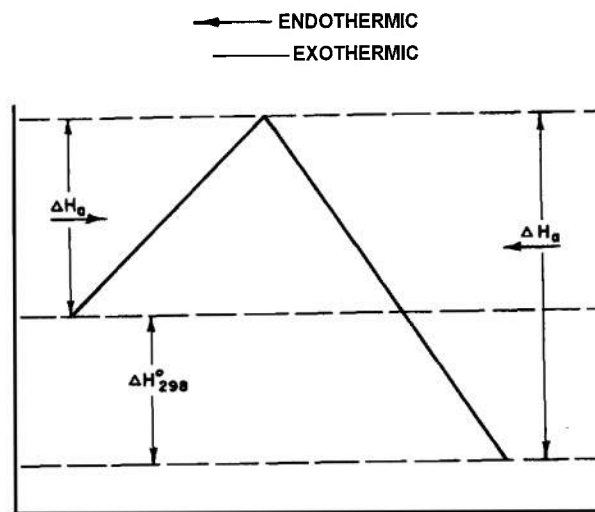

Figure 3-9. The Relationship Between Heat of Reaction and Heat of Activation

The reaction rate is proportional to the product of the concentrations of two reactants or to the concentration of one reactant squared.

Only a very few reactions follow zero, first, second, or third order reactions. Most chemical reactions, especially at the high temperatures involved in most pyrotechnic reactions experimentally determined, are complicated combinations of many simpler reactions. These complications include consecutive reactions, reverse reactions, and side reactions. Hence, it is possible for the order of a reaction to be fractional.<sup>12</sup>

### 3-3.3 INFLUENCE OF TEMPERATURE ON REACTION RATES

The reaction rate is strongly dependent on temperature. A quantitative relationship proposed by Arrhenius relating the specific rate constant and the absolute temperature is:

$$K = s \exp \left[ \frac{-E_a}{RT} \right] \quad (3-73)$$

where  $k$  is the specific rate constant,  $s$  is a constant,  $E$ , is the activation energy,  $R$  is the gas constant, and  $T$  is the absolute temperature. Another somewhat more complicated relationship, based on the theory of absolute reactions rates, is:<sup>13</sup>

$$k = \left( \frac{RT}{Nh} \right) \left( \exp \left[ \frac{\Delta S_a}{R} \right] \right) \left( \exp \left[ \frac{-\Delta H_a}{RT} \right] \right) \quad (3-74)$$

where  $k$  is the specific rate constant,  $R$  is the gas constant,  $N$  is the Avogadro's number,  $h$  is Planck's constant,  $S_a$  is the entropy of activation,  $H_a$  is the enthalpy of activation, and  $T$  is the absolute temperature. The relationship between the heat of activation for the forward and reverse reactions and the heat of reaction:

$$AH \text{ (reaction)} = \Delta H_a \text{ (forward)} - AH, \text{ (reverse)}$$

is illustrated in Figure 3-9 for an exothermic reaction.

### 3-3.4 CHAIN REACTIONS

Theoretical and experimental results indicate that atom-molecule and radical-molecule reactions normally require much smaller activation energies than reactions between two molecular species. A variety of chemical processes proceed by mechanisms which involve free radicals or atoms in a sequence of reactions forming a chain. These processes include thermal and photo-chemical decomposition processes, polymerization and depolymerization processes under the influence of heat and light, as well as a variety of oxidations and halogenations involving hydrocarbons which can give rise to the production of flames and explosions.

In a straight chain reaction, a chain carrier—which may be a free radical, free atom, or an excited molecule or atom—is produced by some suitable primary reaction. This chain carrier reacts with a molecule to produce another molecule and another chain carrier which, in turn, reacts with another molecule to produce another chain carrier. As long as the chain remains unbroken, the disappearance of one chain carrier is accompanied by the formation of another chain carrier. The chain can be **broken** by the removal of the chain carriers, as the result of reactions between chain carriers or between the chain carrier and other reactive materials, or by the collision of a chain carrier with the wall of the containing vessel.

In some cases, the reaction of a chain carrier with a molecule may produce more than one chain carrier. This multiplication of the number of chain carriers, or chain branching, can lead to an infinitely rapid rate for the reaction. Explosions resulting from chain branching are definitely different from thermal explosions. In a thermal explosion, because of the exothermal nature of the reaction and the difficulties attending heat removal, the temperature of the system rises rapidly and an extremely rapid reaction or explosion may result. A branched chain explosion can take place even though isothermal conditions are maintained.

### 3-3.5 HETEROGENEOUS REACTIONS

In heterogeneous systems, reactions take place at phase boundaries. While the kinetics of chemical reactions involving more than one phase is less developed than that for homogeneous systems, the overall process includes at least three steps:

1. Transport of reactants to the phase boundary.
2. Reaction at the phase boundary.
3. Transport of products away from the phase boundary.

As indicated earlier, a series of reactions will have relatively simple kinetics if the rate of one step is much slower than any of the others. Heterogeneous reactions, therefore, are divided into two general types: (a) transport rate controlled, and (b) phase boundary reaction rate controlled.

Reactions involving a gas as one of the reactants are frequently phase boundary reaction rate controlled at low temperatures and pressures; however, many of these reactions become transport rate controlled at higher temperatures. For condensed phase reactions, the transport rates will be even slower so that reactions are often transport rate controlled even at low temperatures.

### 3-3.6 IGNITION AND PROPAGATIVE BURNING

The burning of solid propellants and consolidated pyrotechnic mixtures are similar in many respects. When raised to their ignition temperature, they undergo preignition reactions followed by an ignition reaction. If conditions are favorable,

the reaction front moves at a nominally constant velocity. Propagative burning involves recurring ignition as the reaction front progresses, therefore, ignition and propagative burning processes must be considered together.

### 3-3.6.1 Ignition

The overall process of ignition involves heating a portion of the combustible—such as a propellant, pyrotechnic mixture, or a combustible material in air—to its ignition temperature, the minimum temperature required for the initiation of a self-sustaining reaction. While the overall ignition process can be stated simply, the mechanism of ignition is not known in detail. An ignition stimulus, which can be reduced to the effect of heat absorption, starts a sequence of preignition reactions involving crystalline transitions, phase changes, or thermal decomposition of one or more of the ingredients. In many cases involving propellants and pyrotechnic mixtures, a gaseous phase is formed and combustion starts in the gaseous phase. This is true for wood and similar materials where combustion starts in the gaseous phase after the formation of gaseous combustible intermediates by thermal decomposition of the fuel. Combustion of liquid fuels also starts and takes place in the gaseous phase.

The preignition period begins with the application of the ignition stimulus and ends with the start of self-sustaining combustion. During this period, the rate of heat transfer to, the rate of heat production in, and the rate of heat loss from that portion of the material being ignited, are important. As the temperature rises, the rate of the heat producing reactions will increase as predicted by the Arrhenius equation (Equation 3-73). The rate of heat loss will also increase with temperature but, because of the exponential form of the Arrhenius equation, a temperature may be attained at which the rate of heat generation is greater than the rate of heat loss and ignition will result.

The time to ignition can be expressed by an equation similar in form to the Arrhenius equation.<sup>13,14</sup>

$$t = A \exp \frac{E_a}{RT}$$

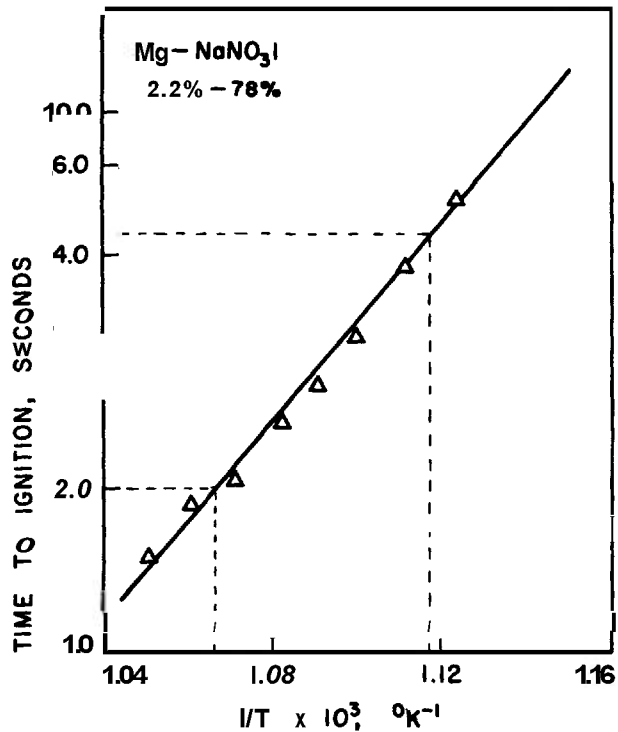

figure 3-70. Ignition Time-Temperature Plots for a Binary Pyrotechnic Mixture

where  $t$  is the time to ignition at the temperature  $T$  in degrees absolute;  $E_a$ , the activation energy, is a constant;  $R$  is the universal gas constant; and  $A$  is a constant, depending upon the material. A large number of propagatively reacting systems, such as explosives, propellants, and pyrotechnic compositions follow this type of equation. The value obtained for activation energy for the ignition process can be considered a measure of the sensitivity of the composition to heat. It will depend, partly, on the specific experimental conditions.

Time to ignition is often measured<sup>15,16</sup> by quickly immersing the sample in a suitable container into a liquid such as molten lead maintained at a constant temperature and observing the time to ignition. As shown in Figure 3-10<sup>17</sup> the results obtained are presented in an Arrhenius type plot in which the natural logarithm of the time to ignition is plotted against the reciprocal of the absolute temperature. An average value for the activation energy for ignition can be obtained by:

$$E_a = [2.3(\text{slope})]R$$

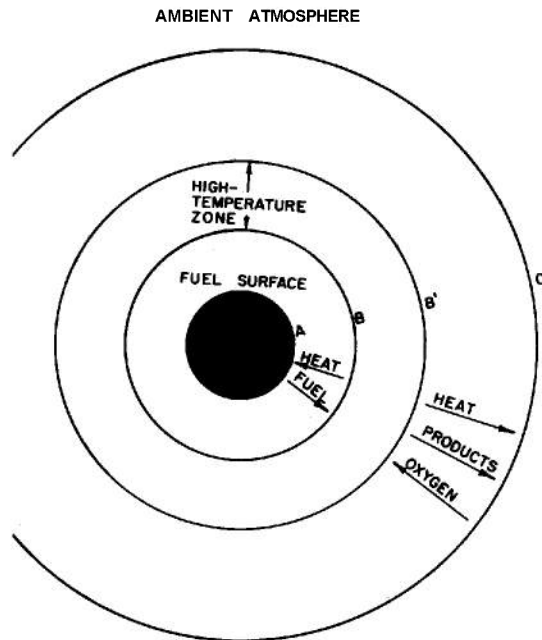

Figure 3-77. Model for Burning of Aluminum Particles

where the factor 2.3 is the conversion factor for natural logarithms into common logarithms and  $R$  is the gas constant expressed in cal per degree-mole.

By using the data plotted in Figure 3-10, the activation energy  $E$ , for ignition of the magnesium-sodium nitrate system can be calculated in the following manner :

Slope of line:

$$\begin{aligned} M &= \frac{y_2 - y_1}{x_2 - x_1} = \frac{2.3(\log 6 - \log 2)}{10^{-3}(1.118 - 1.064)} \\ &= 2.3 \times 10^3 \left( \frac{0.7782 - 0.3010}{0.054} \right) \\ &= 2.3 \times 10^3 \left( \frac{0.4772}{0.054} \right) = 20.35 \times 10^3 \end{aligned}$$

Activation energy :

$$\begin{aligned} E, &= (20.35 \times 10^3) 2 \\ &= 40.7 \times 10^3 \text{ cal/mole} \\ &= 40.7 \text{ Kcal/mole} \end{aligned}$$

### 3-3.6.2 Burning of Metal Particles\*

A primary characteristic of the burning of a metal is the limitation of the temperature attained by the boiling point of the resultant oxide. Al-

though the heats of combustion of metals are relatively high, most of the heat energy obtained from this reaction is used up by the heat of vaporization and dissociation of the oxide. Two models for metal particle combustion which have been proposed based on studies of the burning of aluminum differ mainly in the treatment of the condensed oxide formed by the combustion reaction.<sup>18</sup>

As hollow oxide spheres are formed in the combustion of aluminum, one of the models for self-sustained combustion consists of a vaporizing droplet of aluminum which is surrounded by a bubble of molten aluminum oxide. The reaction rate is determined by diffusion through the alumina shell.<sup>19</sup>

The other model consists of a vaporizing droplet of aluminum surrounded by a detached reaction zone where the condensed alumina product appears as fine droplets. The reaction rate is controlled by the vapor-phase diffusion of aluminum and atmospheric oxidant to the reaction zone.<sup>20</sup> This model, which appears to be most in agreement with the experimental data obtained for burning aluminum particles,<sup>18</sup> is illustrated schematically in Figure 3-11.

Within the limitation of this model, it is possible to predict conditions favoring vapor-phase flames, surface combustion, or no combustion. For those conditions resulting in vapor-phase combustion, the burning rate of spherical droplets  $W$  can be expressed as:<sup>21</sup>

$$W = kr^n \quad (3-77)$$

where  $r$  is the radius of the droplet,  $k$  is a constant involving, among other factors, the latent heat of vaporization, and  $n$  is a constant normally having a value near 1.

### 3-3.6.3 Burning of Solid Propellants

The burning of solid propellants has been extensively studied and, in some cases, the mechanism of burning is reasonably well established. Solid propellants can be classified into two general types, homogeneous propellants and composite propellants. Homogeneous propellants are commonly called double base, or colloidal propellants, because they consist of a colloidal mixture of nitrocellulose and an explosive plasticizer, usually nitro-

glycerin. Relatively small amounts of other materials are added to improve the properties of the propellant. A composite propellant resembles a pyrotechnic mixture in that it is an intimate mixture of a fuel (reductant) and an oxidizer. It consists of a finely divided, solid oxidizing agent in a plastic, resinous, or elastomeric matrix which normally provides the fuel for the combustion reaction. Solid reducing materials are sometimes included and other minor constituents may be added to modify the properties of the binder or to change the burning characteristics.

Combustion processes in solid propellants, as in pyrotechnic mixtures, are complicated because of the several processes involved in the transformation of the solid material, at ambient temperatures, into gaseous, liquid, and solid combustion products at the flame temperature. In general, for all solid propellants, the temperature of the propellant a short distance below the burning surface is not affected by the combustion of the propellant. In propagative burning as the burning surface advances, the unburned propellant is heated, and the temperature of the material increases to the point where the propellant decomposes into volatile fragments. In some cases, liquefaction may occur prior to the chemical reactions which comprise the combustion process.

The solid phase processes for double base propellants, which take place in a  $10^{-3}$  to  $10^{-2}$  centimeter thick layer, are completed at relatively low temperatures, near  $600^{\circ}\text{C}$ . The gas phase reactions can be considered as taking place in three zones. The first zone exists adjacent to the burning surface, and is called the fizz zone, where some exothermic reactions may take place. In the second zone, called the preparation or dark zone, activated intermediates are formed without heat production. When a sufficient concentration of activated intermediates is developed, the final reaction occurs in the flame zone; this reaction produces the constant pressure combustion temperature. The thickness of each of the zones increases with a decrease in ambient pressure.

The burning of composite propellants, as well as pyrotechnic mixtures involving intimate mixtures of fuel and oxidizer, is more complicated than the burning of a double base propellant. In general,

- $T_m$  = MAXIMUM REACTION TEMPERATURE
- $T_i$  = MINIMUM IGNITION TEMPERATURE
- $T_f$  = FUSION TEMPERATURE
- $T_{tr}$  = TRANSITION TEMPERATURE
- $T_o$  = AMBIENT TEMPERATURE
- $\Delta z', \Delta z'', \Delta z''':$  = LENGTH OF ZONES
- 1 = REACTION ZONE
- 2 = ZONE OF FUSION
- 3 = ZONE OF CRYSTALLINE TRANSITION
- 4 = HEAT CONDUCTION ZONE
- $z$  = DIRECTION
- $v$  = VELOCITY OF BURNING

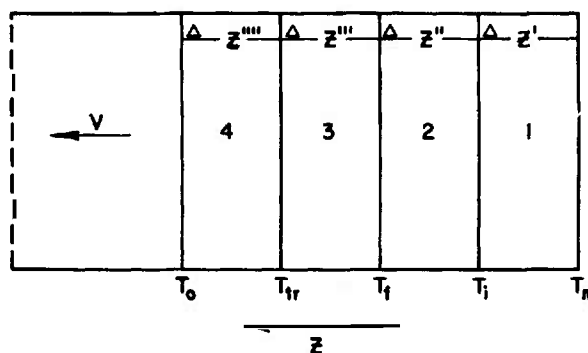

Figure 3-72. Model for Steady State Progressive Burning

as for a double base propellant, the burning of a composite propellant involves the formation of active gaseous intermediates from the fuel and oxidant, which then react.

### 3-3.6.4 Rate of Propagative Burning<sup>22</sup>

The steady state burning rate of a propagative burning system is determined, basically, by the temperature produced by the reaction and by the amount of heat transferred, mainly by conduction, to the unburned composition. These quantities, in turn, are influenced by the ratio of ingredients, external pressure and temperature, rate of chemical reaction, thermal conductivity, particle size distribution, and the porosity of the consolidated composition.

If it is assumed that heat transfer by radiation and diffusion of material can be neglected—and if heat losses from the side are insignificant—the

model for steady state propagative burning illustrated in Figure 3-12 is applicable. It is further assumed that the burning composition can be separated into reaction and preignition zones defined by the limits of the maximum reaction temperature, the minimum ignition temperature, and the ambient temperature, respectively.

Heat, produced as a result of chemical reactions in the reaction zone, is transferred to the adjacent, unreacted composition in the preignition zones, thus affecting physical transitions and initiating preignition reactions. It is assumed that the temperature gradient across the reaction and preignition zones is constant with time, and that the position of these zones changes linearly with time. Other assumptions are that the specific heat, thermal conductivity, and density of the composition remain essentially constant over the temperature ranges involved.

For this model, the following equation can be obtained for the linear rate of burning  $V$ :

$$V = \frac{\sum_i Q N_i n_i [A_i]^{x_i} s \exp \left[ \frac{E_a}{RT} \right]}{\sum_i D C_m \nabla T} \quad (3-78)$$

where  $Q$  is the heat of reaction;  $s$  is the Arrhenius frequency factor;  $N_i$  is the number of fuel particles per unit volume;  $n_i$  is the number of molecules of  $i$ th species, which has an activity  $A_i$ ; and  $x_i$  is the order of the reaction.  $E_a$  is the energy of activation,  $R$  is the universal gas constant,  $T$  the absolute temperature,  $D$  the density,  $C_m$  the mean specific heat, and  $\nabla T$  the temperature gradient. According to this equation, the rate of propagative burning is directly proportional to the net heat of reaction, specific rate, concentration of reactants, and specific surface, and is inversely proportional to the density of the composition, mean specific heat, and temperature gradient across the reaction and preignition zones. The rate of burning is also proportional to the thermal conductivity.

The effect of particle size on the rate of propagative burning can be estimated by assuming that the rate of the chemical reaction is proportional to the rate of change in volume of the spherical particles and that the rate of change in the radius of a reacting particle can be expressed as an exponential function of the particle mass. Under

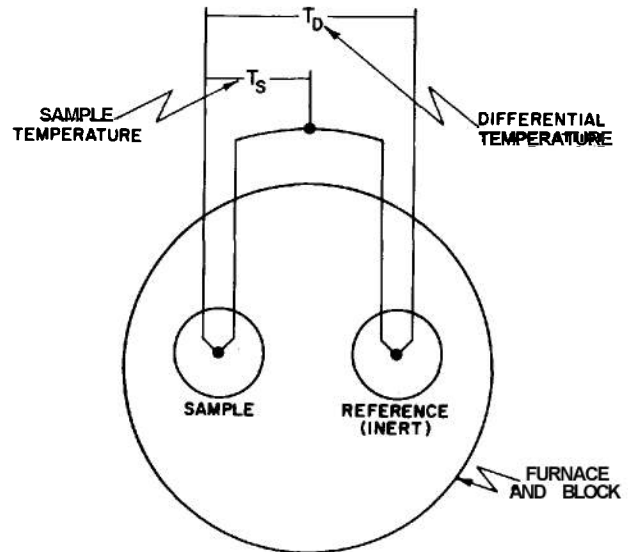

Figure 3-73. Differential Thermal Analysis Thermocouple Circuit

these conditions,  $A_i$  in Equation 3-78 is equal to the mass of a metal particle  $m$ , and  $x_i$  is equal to 0.67 (as the surface area of a particle is proportional to its volume to the 0.67th power) plus a constant  $h$ , defined by the equation.

$$dr/dt = k(m)^h$$

Other reaction parameters will remain essentially constant when the particle size of the metal fuel is changed, and:

$$V_u = V_s \frac{N_u}{N_s} \left( \frac{m_u}{m_s} \right)^{(h + 0.67)} \quad (3-79)$$

The subscript  $u$  refers to the mixture with an unknown burning rate, and the subscript  $s$  refers to standard. The constant  $h$  in the above equation often has a value of about 0.18. More accurate results are obtained if  $h$  is determined experimentally for each mixture.

The derived equation does not include a pressure term; however, several of the parameters which influence the burning rate are affected by

changes in ambient pressure. The pressure dependence of the burning rate  $v$ , for many similar propagative burning reactions at higher pressures, is sometimes given as:

$$v = bp^n \quad (3-80)$$

or by:

$$v = a + bp^n$$

where  $a$ ,  $b$  and  $n$  are constants, and  $p$  is the pressure. At the lower pressure normally encountered in burning of pyrotechnic items, the relationships between the linear burning rate and the pressure may be more complicated.

### 3-4 THERMOANALYTICAL TECHNIQUES<sup>23</sup>

The thermoanalytical techniques of differential thermal analysis (DTA) and thermogravimetry analysis (TGA) are versatile experimental tools which are finding increased application in chemical research. Differential thermal analysis involves the heating of either the ingredient or the mixture

while

Although the techniques of DTA have been widely used in the study of clays, minerals, and soils, relatively little work has been reported utilizing this method to investigate and characterize the thermal decomposition of inorganic compounds. In Figure 3-13, a schematic diagram illustrates the basic measurements required in DTA. The temperature differential between an inert reference compound—e.g., ignited  $\text{Al}_2\text{O}_3$ —and the material under study is measured and recorded as they are both heated to elevated temperatures at a constant rate. The differential temperature is measured at  $T_D$  and the sample temperature at  $T_S$ .

The reference material chosen should be thermally inert and undergo no endothermal or exothermal reactions over the temperature range under consideration. Consequently, the inert sample heats at a rate equal to that of the furnace. When the sample being analyzed undergoes an endothermal reaction, its temperature remains relatively constant or increases very slowly. Therefore, since the

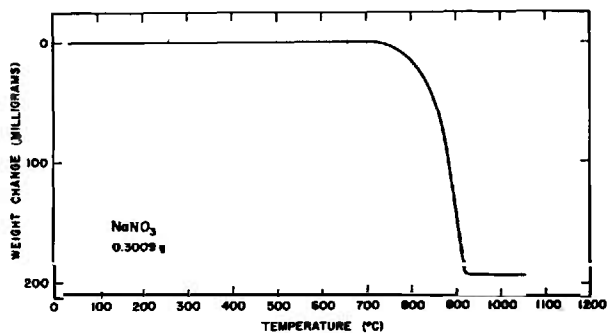

Figure 3-14.1. Thermogravimetric Curve for the Ingredient Sodium Nitrate

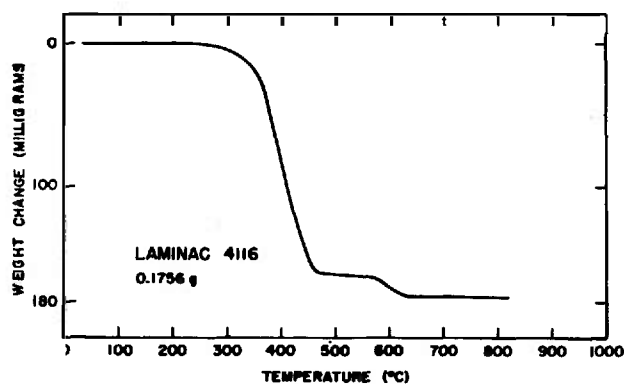
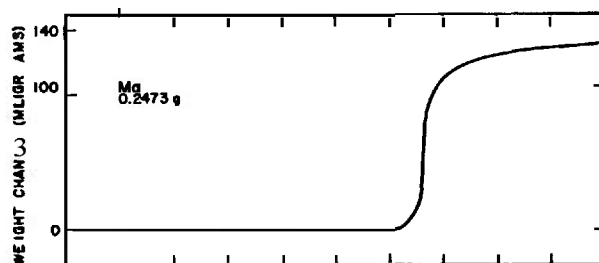

Figure 3-14.3. Thermogravimetric Curve for the Ingredient Laminac 4776

temperature of the inert sample is constantly increasing, an endothermal differential temperature results. Conversely, an exothermal reaction causes the sample temperature to increase more rapidly than the reference temperature, and the result is an exothermal differential. When there is no thermal reaction, the sample and reference compounds heat



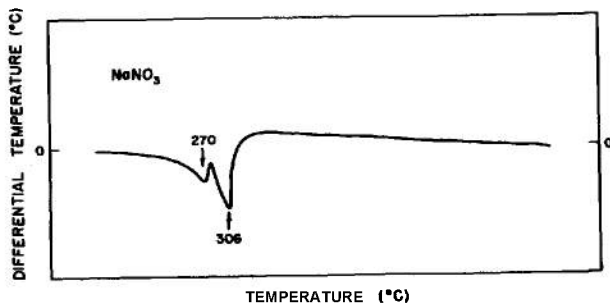

Figure 3-75.7. Differential Thermal Analysis Curve for the Ingredient Sodium Nitrate

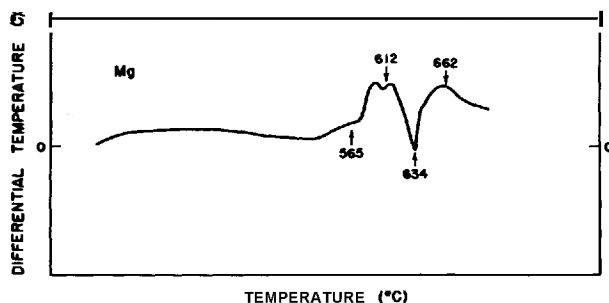

Figure 3-15.2. Differential Thermal Analysis Curve for the Ingredient Magnesium

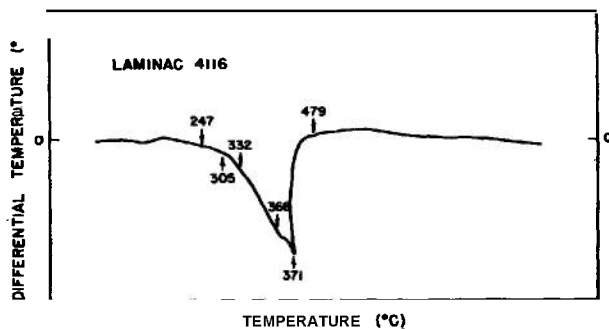

Figure 3-75.3. Differential Thermal Analysis Curve for the Ingredient Laminac 4776

at the same rate and no differential temperature is observed. Dehydration of a hydrated or hygroscopic substance is an endothermic process as are those of fusion boiling. Transitions involving transformations from one crystal lattice to another, or the free rotation of ions in a lattice are, most often, endothermic processes; however, there are several isolated exceptions to this general rule. Decomposition reactions may be either endothermic or exothermic depending upon the system and tempera-

ture under consideration. Oxidation of a material such as a metal powder by a gas, e.g., oxygen or nitrogen, involves the evolution of heat and is, therefore, an exothermic reaction. Oxidation-reduction reactions normally are exothermic processes, particularly when considering reactants such as metal fuels and solid oxidants. Since these types of phenomena are indicated by the DTA curves obtained, these curves may be used to characterize the system under study in terms of its thermal reactions, both physical and chemical. Integration of areas under endothermic bands also has been used to obtain a semi-quantitative estimate of the amount of one or more of the ingredients present.

Thermogravimetry consists of continuously weighing a sample as it is heated, either at a constant temperature or to elevated temperatures at a constant rate. Curves are obtained as a function of temperature or time. Since thermogravimetric curves are quantitative representations of weight changes, they can be related to the chemical and physical changes taking place in the sample as it is heated, and can often be used to determine the nature of the intermediate and final reaction products.

Typical results obtained by thermogravimetric and differential thermal analyses techniques are illustrated by the results obtained in a study of the pyrotechnic illuminating mixture composed of 54 percent magnesium, 36 percent sodium nitrate, and 10 percent Laminac.<sup>24</sup> The thermogravimetric studies under normal atmospheric conditions indicate that all three ingredients undergo thermal reactions involving weight change as a function of furnace temperature, as illustrated in Figures 3-14.1 through 3-14.3. Sodium nitrate exhibits a weight loss at temperatures from 700°C to 1000°C which corresponds to a complete conversion to sodium oxide. The curve also shows a point of inflection at about 850°C due to the concurrent decomposition of the intermediate product, sodium nitrite. Magnesium shows a continuous gain in weight which begins at about 625°C and continues on past the maximum temperature. The curve varies in slope, becoming perceptibly steeper at 650°C, and markedly less steep at 680°C. This weight gain is attributed to the successive formation of magnesium nitride and magnesium oxide.

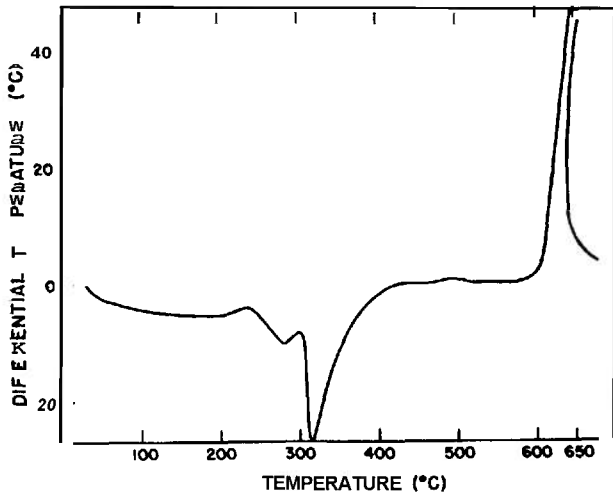

Figure 3-76.7. Differential Thermal Analysis Curve for the Magnesium-Sodium Nitrate Mixture (Curve I)

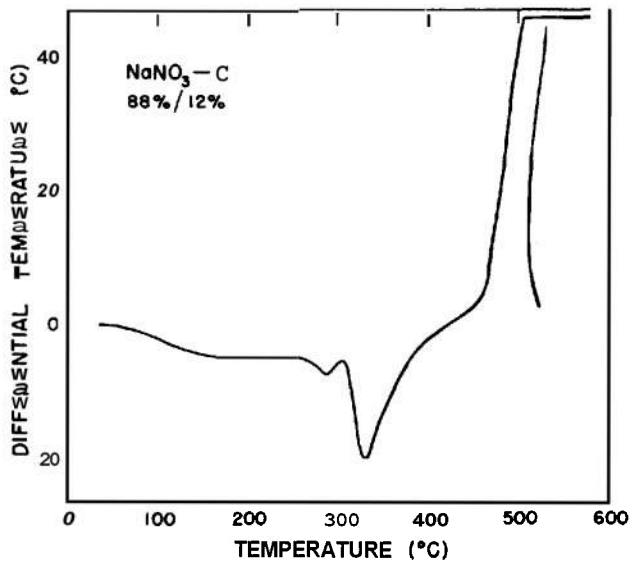

Figure 3-76.2. Differential Thermal Analysis Curve for the Sodium Nitrate-Carbon Mixture

Polymerized Laminac first shows a continuous weight loss, extending from about 100°C to 500°C, which markedly changes in slope at 350°C. This loss is followed by another loss, ending at 625°C, which represents a loss in weight equivalent to the initial weight of the sample. This loss is due to chemical degradation of the polymer to carbon, which is then completely oxidized.

The DTA curves for the ingredients are illustrated in Figures 3-15.1 through 3-15.3. The only thermal effect exhibited by sodium nitrate is en-

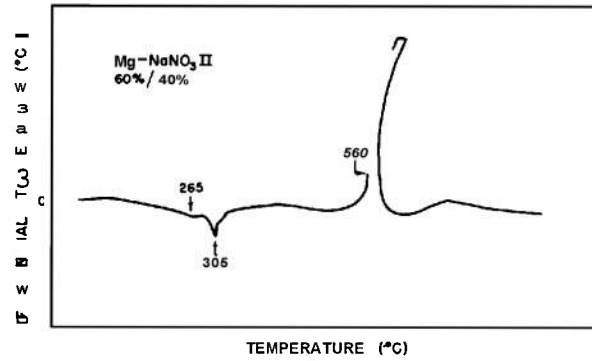

Figure 3-76.3. Differential Thermal Analysis Curve for the Magnesium-Sodium Nitrate Mixture (Curve II)

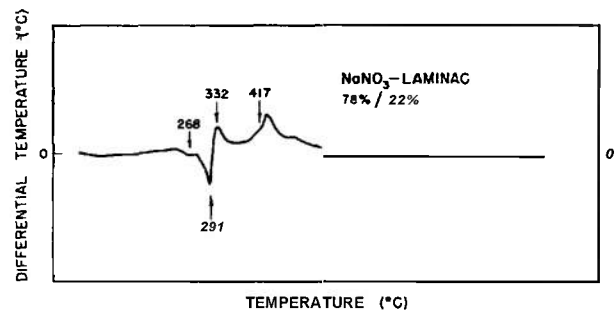

Figure 3-76.4. Differential Thermal Analysis Curve for the Sodium Nitrate-Laminac Mixture

dothemic crystalline transition at 270°C, immediately followed by endothermic fusion at 306°C. The differential thermogram of magnesium shows a double exothermic peak beginning at about 565°C, which may be due to the formation of magnesium nitride or magnesium oxide on the surface of the metal, or to reaction with the glass tube. The double peak culminates in the endothermic fusion of magnesium. The DTA curve of polymerized Laminac displays only one broad, endothermic band, beginning at about 250°C, with a peak temperature of 371°C. However, it appears as though several overlapping reactions are responsible for the heat absorption. At 305°C, a colorless liquid condenses on the upper part of the sample tube. At 332°C, there are dense, white fumes escaping from the tube. At 479°C, after the endotherm is over, the sample gives off dense, yellow fumes and some charring is observed in the tube.

As shown in Figures 3-16.1 through 3-16.5, the binary fuel mixture, magnesium-Laminac, gives

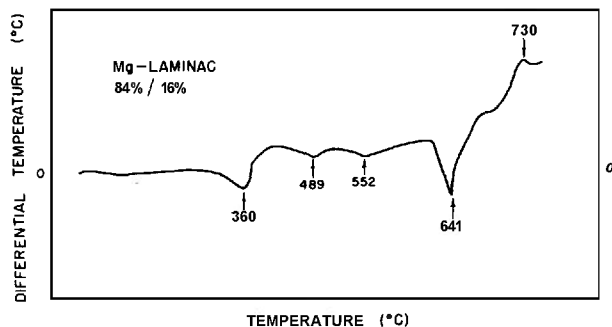

Figure 3-16.5. Differential Thermal Analysis Curve for the Magnesium-Laminac Mixture

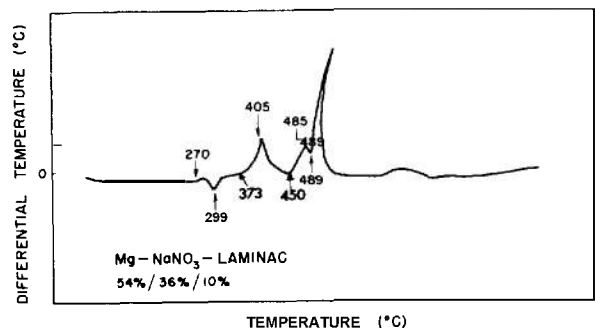

Figure 3-17.2. Differential Thermal Analysis Curve for the Magnesium-Sodium Nitrate-Laminac Composition

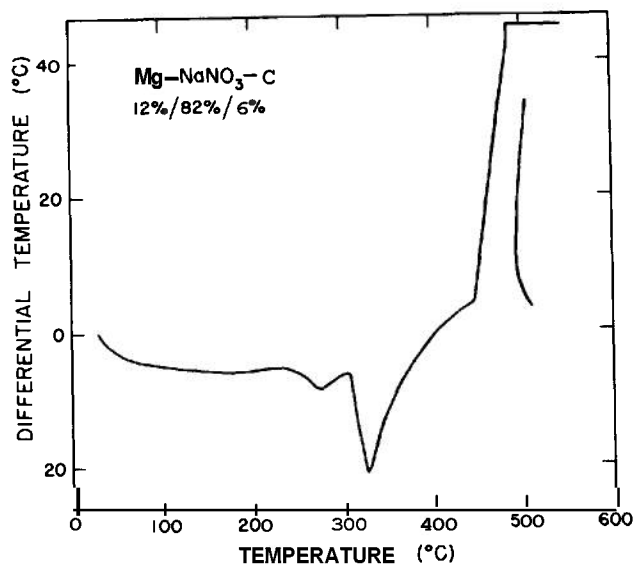
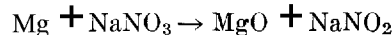

Figure 3-17.1. Differential Thermal Analysis Curve for the Magnesium-Sodium Nitrate-Carbon Composition

DTA evidence of the thermal decomposition of the Laminac present by several shallow endotherms prior to the sharply endothermic fusion of magnesium. The magnesium fusion endotherm is followed by an exothermal reaction, probably the oxidation of molten magnesium. The absence of any exothermal peak prior to magnesium fusion suggests that, although the Laminac does not react with the bulk of the metal, it protects the solid magnesium from reaction with air. The four binary fuel-oxidant mixtures did ignite. For all the ignitable sodium nitrate compositions run on the time-base apparatus, the endotherms corresponding to the crystalline transition of sodium

nitrate are very small because only very small samples were used. The fuel-rich system 60-40 magnesium-sodium nitrate, Curve II, used in the test, ignited at 560°C. The DTA curve shows the endothermic Crystalline transition of sodium nitrate at 265°C, and its fusion at 305°C, in addition to the sharply exothermic ignition. The stoichiometric mixture, Curve I, for the reaction:



containing only 22 percent magnesium, ignited at 613°C and displayed endotherms at 270° and 310°C which were caused, respectively, by the crystalline transition and fusion of sodium nitrate. Sodium nitrate-Laminac ignited with an apparently small evolution of heat at 417°C that may have been due to a combination of small sample size and formation of gaseous products. The differential thermogram exhibits the crystalline transition of sodium nitrate at 268°C and its fusion at 297°C. A broad, shallow endotherm, during which a colorless and then a yellow liquid condenses on the sample tube, culminates in ignition. The sodium nitrate-carbon system exhibits the crystalline transition of sodium nitrate, successfully followed by sodium nitrate fusion, and then ignition at 467°C.

DTA curves for the two ternary compositions are shown in Figures 3-17.1 and 3-17.2. The mixture containing magnesium, sodium nitrate, and carbon is very similar to the sodium nitrate-carbon binary mixture; i.e., it ignited at 455°C immediately following the crystalline transition and fusion of the sodium nitrate. The mixture containing magnesium-sodium nitrate-Laminac ignited at 489°C. The first thermal phenomena observed were the

crystalline transition and fusion of sodium nitrate at 270°C and 299°C, respectively. There was a small, sharp exothermal reaction beginning at 373°C, and another beginning at 450°C, with peak temperatures of 405°C and 485°C, respectively. Ignition occurred as the system was recovering

from the second exothermal reaction. These and related results indicate that it is not feasible to write preignition or combustion reactions for the systems containing Laminae due to the complexity of the polymer and the uncertainty of its combustion products.

## REFERENCES

1. M. T. Howerton, *Engineering Thermodynamics*, Van Nostrand Co., Inc., Princeton, N. J., 1962.
2. *Handbook of Chemistry and Physics*, 45th Ed., The Chemical Rubber Co., 1964-65.
3. G. Custard, G. Francis, W. Schnackenberg, *Small Arms Incendiaries, A Review of the History and Development*, 4 Vols, Frankford Arsenal Report R1407, 1956.
4. Reilly and Rae, *Physico-Chemical Methods*, 2nd Ed., Van Nostrand Co., Inc., Princeton, N. J., 1932.
5. Walter J. Moore, *Physical Chemistry*, 3rd Ed., Prentice-Hall, N. Y., 1962.
6. O. Kubaschewski and E. Evans, *Metallurgical Thermochemistry*, John Wiley & Sons, N. Y., 1956.
7. Irving M. Klotz, *Chemical Thermodynamics*, Prentice-Hall, N. Y., 1950.
8. Irving Glassman, *Metal Combustion Processes*, Paper presented at 14th Annual Meeting, American Rocket Society, Nov. 16-20, 1959.
9. S. Glasstone and D. Lewis, *Elements of Physical Chemistry*, Van Nostrand Co., Inc., Princeton, N. J., 1960.
10. AMCP 706-282, Engineering Design Handbook, *Propulsion and Propellants*.
11. J. B. Conway, A. V. Grosse, *Powdered Metal Flames*, Office of Naval Research, Contract N9-ONR-87301, Washington, D. C.
12. Keith J. Laidler, *Chemical Kinetics*, McGraw-Hill Book Co., Inc., N. Y., 1950.
13. S. Glasstone, K. J. Laidler, and H. Eyring, *The Theory of Rate Processes*, McGraw-Hill Book Co., Inc., N. Y., 1941.
14. E. S. Freeman and S. Gordon, "The Application of the Absolute Reaction Rate Theory to the Ignition of Propagative Reaction Systems. The Thermal Ignition of the Systems Lithium Nitrate-Magnesium, Sodium Nitrate-Magnesium," *Journal of Physical Chemistry* **60**, 867-71 (1956).
15. S. Gordon and C. Campbell, "Pre-ignition and Ignition Reactions of Pyrotechnic Systems, *Proceedings of the Fifth Symposium on Combustion*, Reinhold Publishing Corp., N. Y., 1955.
16. H. Henkin and R. McGill, "Rates Explosive Decomposition of Explosives," *Industrial and Engineering Chemistry* **44**, 1391-5 (1952).
17. M. Gilford, S. Gordon, G. Weingarten, *Thermal Parameters Associated With the Ignition of the Magnesium-Sodium Nitrate Systems*, Picatinny Arsenal Technical Note 27, Dover, New Jersey.
18. H. C. Christensen, R. H. Knipe, A. S. Gordon, *Survey of Aluminum Particle Combustion*, Paper presented at Meeting of the Western States Section of the Combustion Institute, University of Utah, Salt Lake City, Oct. 26-27, 1964.
19. W. M. Fassell, C. A. Papp, D. L. Hilenbrand, and P. P. Sernka, *The Experimental Nature of the Combustion of Metallic Powders*, Solid Propellant Rocket Research, Academic Press, N. Y., 1960.
20. T. A. Brzustowski, *Vapor-Phase Diffusion Flames in the Combustion of Magnesium and Aluminum*, Ph.D. Thesis, Princeton University, 1963.
21. D. K. Kuehl, *The Ignition and Combustion of Small Diameter Aluminum Wires*, Paper

**REFERENCES (cont'd)**

- presented at Western States Section of the Combustion Institute, University of Utah, Salt Lake City, Oct. 26-27, 1964.
22. Eli Freeman and Garry Weingarten, *A Thermal Theory for Rates of Propagative Burning*, Picatinny Arsenal Technical Report 2596, Dover, New Jersey, 1956 (DDC AD 218 171).
  23. S. Gordon and C. Campbell, *Differential Thermal Analysis of Inorganic Compounds*, Picatinny Arsenal, Dover, New Jersey.
  24. V. D. Hogan and S. Gordon, *Pre-ignition and Ignition Reactions of the System Magnesium-Sodium Nitrate-Laminae*, Picatinny Arsenal Technical Note 23, Dover, New Jersey, 1958.

## CHAPTER 4

### VISIBILITY

#### 4-1 INTRODUCTION

In the design and development of military pyrotechnic devices for illuminating a selected area, and for visual signaling when other methods of communication are impractical or impossible, an understanding of human visual performance is important. The complex tasks performed in modern military operations require sufficient light in order that unfamiliar objects can be located and recognized against their backgrounds.

Signaling by methods which depend on sight are commonly used in military tactics, in training exercises, and in evaluation of performance of military items during development programs. These signals derive from packaged units designed to emit smoke, flame, or light, or otherwise to give visual indication of some event, e.g., the marking of a particular spot on the ocean, or to trace the trajectory of missiles or other moving devices. They may be coded by color to convey information relating to different types of events or a sequence of events. For example, a red signal might be used to indicate the arming of a fuze and a green signal to indicate when functioning occurs. Signals for marking purposes can be used to aid in tracking enemy submarines, to allow submerged submarines to make their positions known, to locate tow targets, and to call attention to survivors of air crashes or sinkings.

#### 4-2 VISION

Inasmuch as vision is a sensation recorded by the eye, it is important to consider some of the properties and characteristics of the eye. The functioning of the eye involves a complex of physical, physiological, and psychological factors. Light falling upon the eye acts as a stimulus to produce a sensation which, in the simplest case, is a sensation of brightness.

The eye contains two types of receptors, the rods

and the cones. The central portion of the retina, the fovea, is populated exclusively by cones, and is the area of color perception. The region immediately surrounding the fovea is known as the parafovea and contains the rods, which do not recognize colors. The eye has two distinct states—the light-adapted state and the dark-adapted state. The eye is in the light-adapted state when the field luminance is about  $10^{-3}$  candella per square foot, and is dark-adapted at luminances below this. However, the eye is not fully dark-adapted until it has been exposed to the low level of luminance for about 30 minutes. Only two to three minutes are required for the transition for the dark-adapted to the light-adapted state.

In the light-adapted state both the rods and cones are receptive to light. In the dark-adapted state only the parafovea, composed of rods, is active, with the results that color differences are not recognized and that faint signals are best seen when off to a side (looked at “out of the corner of the eye”) rather than when looked at directly.

#### 4-2.1 BRIGHTNESS CONTRAST

An object can be distinguished from its background (or from another object) because it has a different color or brightness. It has been shown experimentally that differences in brightness are usually much more important than differences in color. The brightness contrast  $C$  is defined by the equation:

$$C = \frac{B - B'}{B'} \quad (4-1)$$

where  $B$  is the brightness of the object and  $B'$  is the brightness of the background. If an object is not as bright as its background, the brightness contrast is negative and approaches a value of  $-1$  as a limit. When the object is brighter than its background, the contrast may be very large, for ex-

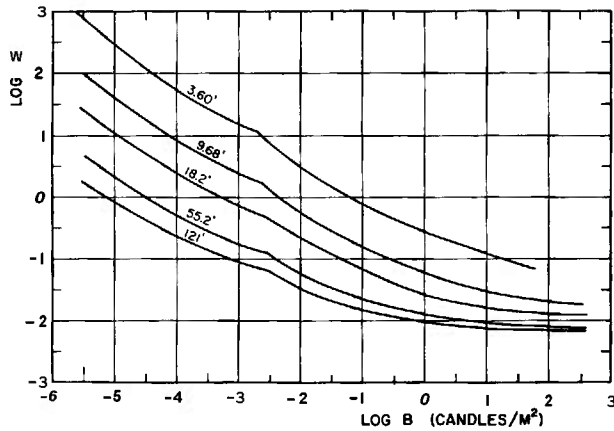

figure 4-7. Thresholds of Brightness-Contrast for 80% Detection for Five Angular Fields (Minutes of Arc)

ample, a bright light on a dark night. The brightness contrast in daylight or in artificially produced white light, where the difference in brightness is due mainly to the amount of light reflected by the object as compared to its background, seldom exceeds a value of 10. If an area has been camouflaged, the brightness contrast may be 0.1 or less.

If the brightness ratio  $B/B'$  approaches unity, a stage is reached where an object can no longer be distinguished from its background.

While the threshold contrast varies with each individual, average values as shown in Figure 4-1 depend on the angle which the object subtends at the observer's eye and the mean level of illumination. For daylight conditions, a value of 0.02 is generally accepted as an average value for the threshold contrast or limen.

Visual acuity is often expressed as the reciprocal of this angle in minutes of arc. An acuity value of 1.0 is accepted as a standard for normal vision even though, under ideal conditions, much greater detail can be resolved.

Up to about one-fifth second, the photochemical reciprocity law applies and the product of the illumination times the duration is a constant. It has been demonstrated in threshold measurements of visual performance that, in those cases where the duration is longer than one-fifth second (as is true for most cases of interest in pyrotechnics), this is not applicable.

#### 4-2.2 OVERALL CONTRAST

The overall contrast  $C_o$  between an object and its background is approximately :

$$C_o = (C_b^2 + C_c^2)^{1/2} \quad (4-2)$$

where  $C_b$  is the brightness contrast, and  $C_c$  is the achromatic brightness contrast, equivalent to the chromatic component of the contrast. As chromatic components of contrast are rarely over 25 percent of the total and are invariably associated with brightness contrasts greater than 25 percent, visibility, under field conditions, depends primarily on the brightness contrast. This is especially true for objects viewed at a distance since the scattered light from all sources tends to still further dilute the color contrast. Where brightness contrasts are limited, as in the case of signal flags or panels, color difference may increase visibility. However, at or near the limit of visibility, the hues of chromatic target are not perceptible. This is particularly true for violet, blue, green, and yellow stimuli. Orange, red-purple, and red appear reddish or brownish under these circumstances.

#### 4-3 ATTENUATION OF CONTRAST

The apparent contrast (both brightness and achromatic) between an object and its background is reduced when viewed through a medium which scatters and absorb light. For a **homogeneous** medium like the atmosphere, containing both the observer and the object, the amount of contrast reduction is governed by the balance between the light transmitted from the object, and its background, and the space light contributed by the intervening medium. If the medium is stratified, as would be the case when a smoke screen is located between the object and the observer, reflection due to multiple-scattering may still further reduce the apparent contrast.

In general, if the inherent brightness contrast between two objects, or of an object and its background, is given by Equation 4-1, the apparent brightness contrast  $C_x$ , when viewed at a distance, will be:

$$C_x = \frac{(B - B')e^{-\beta x}}{B'e^{-\beta x} + G} \quad (4-3)$$

where  $B$  is the brightness of the first object and  $B'$  is the brightness of the second object or the background,  $\beta$  is the scattering coefficient,  $x$  is the distance, and  $G$  is the glare scattered and reflected by

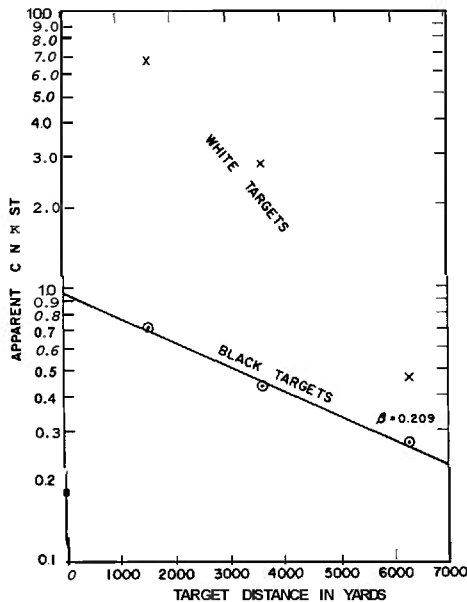

Figure 4-2. Apparent Contrast as a Function of Distance

a cloud in the same direction as the light from the object. The object will be visible only if the apparent contrast is greater than the threshold contrast or "limen" for the particular total illumination level.

### 4-3.1 ATTENUATION OF CONTRAST BY THE ATMOSPHERE

The apparent contrast between two distant objects, or a distant object and its background, is reduced as shown in Figure 4-2 when they are viewed through an atmospheric aerosol. This reduction in apparent contrast limits the maximum distance at which targets and signals can be seen.

The most general expression for the reduction of contrast by the atmosphere is:

$$C_{\bar{R}} = \frac{B}{B'} C e^{-\beta \bar{R}} \tag{4-4}$$

$C_{\bar{R}}$  is the apparent contrast between two objects, or an object and its background at the effective

(slant) range  $\bar{R}$ ;  $C$  is their inherent contrast;  $B$  is the brightness of the object;  $B'$  is the brightness of the background (or second object); and  $\beta$  is the scattering coefficient.

If the atmosphere is optically homogeneous, i.e., the apparent brightness of the sky is not changed by moving toward or away from the horizon, this equation reduces to:

$$C_x = C e^{-\beta x} \tag{4-5}$$

where  $C_x$  is the apparent contrast at a distance  $x$ .

The meteorological range, the horizontal range for which the transmission of the atmosphere is two percent, is given by:

$$X_R = \frac{1}{\beta} \ln 0.02 = \frac{3.912}{\beta} \tag{4-6}$$

The meteorological range is the distance at which a large black object, which has an inherent contrast of  $-1$ , can just be recognized against a daytime sky. Visibility, as normally reported, is about  $\frac{3}{4}$  the meteorological range. The meteorological ranges for typical weather conditions are given in Table 4-1.

If the object is viewed against backgrounds other than the sky, the expressions are more complicated. The apparent contrast at an effective distance  $\bar{R}$  of a target against any background is given by:

$$C_{\bar{R}} = \frac{C}{1 + (B_H/B')(e^{\beta \bar{R}} - 1)} \tag{4-7}$$

where  $C$  is the inherent contrast between the object and its background,  $B_H/B'$  is the ratio of the brightness of the horizon sky in the direction of the object to that of the background, and  $\beta$  is the scattering coefficient. If the ratio  $B_H/B'$  is one, this equation reduces to the equation applicable to the visibility of an object against the horizon sky.

The calculation of the visibility of an object, when viewed from above, is complicated due to the stratification of the atmosphere. If this stratification can be considered continuous, the scattering coefficients will vary regularly and in a predictable manner. Normally, however, this is not true, and the effective optical range  $\bar{R}$  is taken as the horizontal distance containing as many scattering particles as are found in the slant path  $R$ . The



**TABLE 4-1**  
**METEOROLOGICAL RANGE FOR TYPICAL WEATHER CONDITIONS**

<i>Weather</i>	<i>Daylight Visual Range, V</i>	<i>Attenuation Coefficient, B, Per Sea Mile</i>	<i>Transmission, Per Sea Mile</i>
Dense fog	50 yards	156.4	0.0240
Thick fog	200	39.1	0.0210
Moderate fog	500	15.6	0.024
Light fog	1000	7.82	0.02 <sup>2</sup>
Thin fog	1 sea mile*	3.91	0.02
Haze	2	1.95	0.141
Light haze	3	1.30	0.272
	4	0.98	0.376
Clear	5	0.782	0.457
	6	0.651	0.521
	7	0.559	0.572
	8	0.488	0.614
	9	0.434	0.640
Very clear	10	0.391	0.676
	11	0.356	0.700
	12	0.326	0.723
	14	0.279	0.756
	16	0.244	0.783
Exceptionally clear	18	0.217	0.805
	20	0.196	0.823
	24.1	0.162	0.85
	37.1	0.105	0.90
	71.8	0.051	0.95
Theoretically pure air	167	0.0234	0.976

\* 1 sea mile equals 1.15157 statute miles or 6080 feet.

effective optical range  $\bar{R}$  is related to actual path by :

$$\bar{R} = \frac{21,700}{\sin \Theta} \left( 1 - e \left[ \frac{-R \sin \Theta}{21,700} \right] \right) \quad (4-8)$$

where  $\Theta$  is the angle that the slant path  $R$  makes with the horizontal. Plots of this equation for various values of  $\Theta$ , applicable for intermediate values of the slant range  $R$ , are presented in Figure 4-3. The values of the true altitude are indicated by the dashed lines on this diagram.

#### 4-3.2 OBSCURATION OF VISION BY ARTIFICIAL SMOKE CLOUDS

The influence of artificially produced smoke clouds on visibility is complicated by the fact that

the smoke may occupy only a relatively narrow region between the target and the observer. Under these circumstances, the intensity of illumination may vary greatly depending on the relative location of the object, the observer, the smoke cloud, and the source(s) of illumination, so that the quantity of smoke required for obscuration is a highly variable quantity. Because of the complicated way in which the incident light is scattered as a function of angle and because of multiple scattering, the degree to which light will penetrate a cloud can only be approximated. While a major fraction of the light scattered by particles near the optimum size for a screening smoke is scattered in the forward direction, some light is

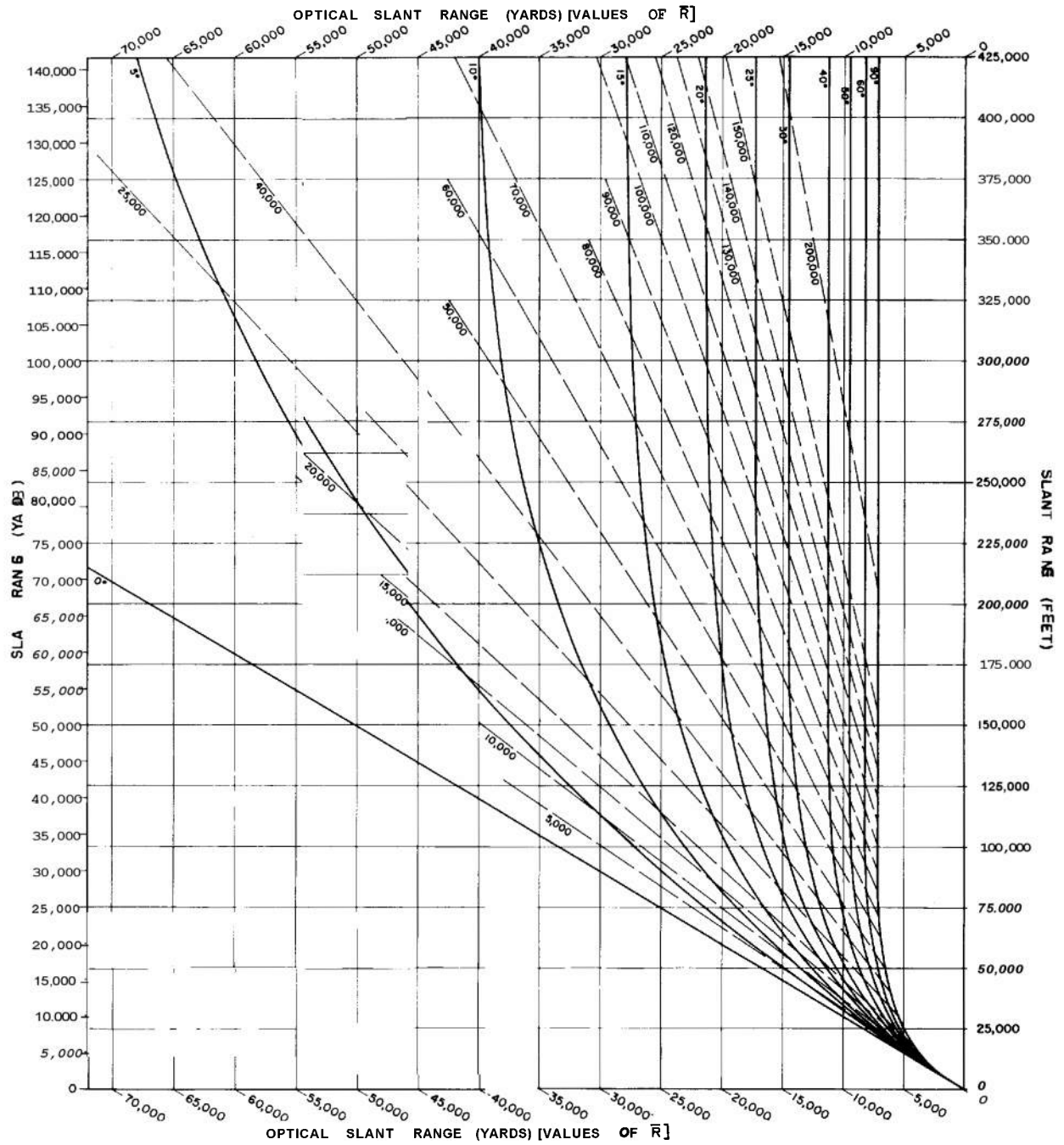

Figure 4-3. Optical Slant Range Diagram for the Optical Standard Atmosphere

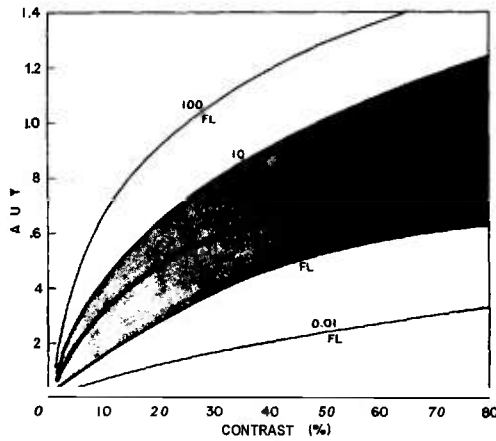

Figure 4-4. Brightness Requirements as a Function of Acuity and Contrast

scattered in the backward direction. If a cloud is of a sufficient depth and concentration, essentially all of the light not absorbed by the cloud will return to and be scattered from the same side of the cloud that it entered and the cloud will behave as a white body diffusely reflecting the light which falls upon it.

For a thinner cloud, part of the incident light will penetrate to the target and background. The apparent contrast of the target against its background, in this case, is:

$$C_{\bar{R}} = I_o(1 - f)(M - \bar{M}')e^{-\beta\bar{R}} \quad (4-9)$$

where  $I_o$  is the effective intensity of the incident light,  $M$  is the reflectivity of the target,  $\bar{M}'$  is the reflectivity of the background,  $\beta$  is the scattering coefficient,  $\bar{R}$  is the effective distance from the target to observer, and  $f$  is the fraction of incident light which penetrates to the target. The amount of light reaching the target, as well as the attenuation of the contrast between the target and its background, depends on the number of scattering particles which, in turn, depends on the product of the concentration of the smoke and the thickness of the cloud.

The effectiveness of a smoke screen also depends on the relative location of the smoke target background and light source. The effect of these changes in relative locations is complicated, and has not been worked out in detail. In general, anything which tends to increase the effective brightness of the smoke cloud, as well as anything that tends to

reduce the illumination on the target and background, will increase the effectiveness of a smoke screen.

#### 4-4 VISIBILITY OF TARGETS AND SIGNALS

The distance at which a ship, low-flying aircraft, shoreline, or other target, and also the distance at which a signal can be seen against its background depends mainly on (1) the perceptual capacity of the observer at the level of brightness to which his eyes are adapted and (2) the apparent contrast between the target and its background and the angle it subtends at the eye of the observer. The angle, subtended by a target area, depends on the size and shape of the object. For a circular target at a distance of  $X$  yards, the angle  $\alpha$  subtended by a circular target  $A$  square feet in area, is :

$$\alpha = \frac{1293\sqrt{A}}{X} \text{ minutes of arc} \quad (4-10)$$

As the apparent contrast is also a function of the distance, calculations intended to determine the range at which a target or signal can be sighted must be a series of successive approximations. In addition, because of the curvature of the earth, the target or signal, or the observer, must be elevated for sighting long distances. The geometrical range for various heights is given by:<sup>2</sup>

$$X = 1.325(H+h) \quad (4-11)$$

where  $H$  is height of target or signal in feet,  $h$  is height of observer in feet, and  $X$  is the distance in miles.

##### 4-4.1 VISIBILITY OF TARGETS UNDER ARTIFICIAL ILLUMINATION<sup>3</sup>

It is impractical to require that normal visual acuity (resolution of one minute of visual arc) be maintained when the illumination is provided by pyrotechnic flares since there is a practical limit to the intensity. The intensity should be such that targets, having a size and a contrast with the background that is typical of field conditions, can be readily located and recognized. Intensities greater than this minimum are excessive. As shown in Figure 4-4, illumination levels between 0.1 and 10.0 foot-lamberts (FL)\*, which can be obtained

\* NOTE 1 millilambert  $\approx$  1 foot-lambert.

**TABLE 4-2**  
**REFLECTANCE VALUES (IN PERCENT) OF VARIOUS TERRAIN**  
**FEATURES AND BUILDING MATERIALS**

<i>Object</i>	<i>Wavelength in Microns</i>						
	<i>0.4</i>	<i>0.5</i>	<i>0.6</i>	<i>0.7</i>	<i>0.8</i>	<i>0.9</i>	<i>1.0</i>
<b>I. Natural Terrain</b>							
<i>a. Soils:</i>							
Dry yellow earth	8	16	37	55	69	76	82
Wet yellow earth	5	9	25	42	58	67	76
Dry sand	18	28	37	45	52	56	58
Wet sand	10	15	26	32	37	41	43
Dry red earth	8	8	20	28	<b>33</b>	<b>35</b>	37
Wet red earth	6	6	12	28	22	24	25
Dry brown earth	8	<b>11</b>	15	<b>19</b>	21	23	24
Wet brown earth	4	6	<b>11</b>	14	15	17	<b>19</b>
Dry loam	8	12	18	20	20	21	22
Wet loam	5	6	7	<b>9</b>	10	<b>11</b>	<b>11</b>
<i>b. Vegetation:</i>							
Grass	6	8	10	<b>13</b>	55	67	70
Evergreens	<b>3</b>	4	7	6	24	24	24
Straw	7	15	24	<b>33</b>	<b>39</b>	44	46
Dead grass	7	<b>13</b>	20	26	<b>31</b>	<b>35</b>	37
Dead brown leaf	6	9	<b>11</b>	27	43	51	69
Dead yellow leaf	6	10	23	<b>39</b>	45	48	51
<i>c. Terrain as seen from 4,000 feet:</i>							
Green field					4	7	10
Brown field					3	4	5
Yellow-green vegetation					5	8	15
Light sand					12	16	21
Sandy ground					8	12	14
Wet mud					5	8	9
Mud covered with water					4	7	6
Pond water					3	2	1
Water with suspended material					3	4	5
Dark volcanic rock					6	6	7
Black asphalt runway					4	4	4
<b>II. Building Materials</b>							
<i>a. Paints:</i>							
Black					4	4	4
Black					6	6	<b>11</b>
Earth brown					9	15	45
Earth yellow					6	7	19
Earth red					15	24	42
Sand					16	<b>21</b>	<b>37</b>
Desert sand					7	9	16
Field drab					4	7	1
Olive drab					4	6	7
Forest green							5

TABLE 4-2 (cont'd)

Object	Wavelength in Microns						
	0.4	0.5	0.6	0.7	0.8	0.9	1.0
<b>II. Building Materials (Continued)</b>							
<i>a. Paints (Continued):</i>							
Dark green				5	7	6	6
Sky gray				33	40	48	45
Haze gray				35	33	24	24
Blue gray				25	27	25	23
Ocean gray				22	20	13	13
Sea gray				14	13	12	10
Slate gray				9	10	9	7
Sea blue				7	6	5	4
Red				5	5	25	75
<i>b. Materials:</i>							
Concrete tiles (uncolored)		28	35	37	37	37	37
Concrete tiles (black)		9	9	9	9	9	9
Slates (silver gray)		19	20	21	21	21	21
Slates (blue gray)		12	13	14	14	15	16
Slates (dark gray)		10	12	12	12	11	10
Clay tiles (Dutch light red)		23	51	64	66	66	65
Clay tiles (red)		11	28	35	37	40	40
Clay tiles (red-brown)		13	25	30	33	40	41
Dark concrete	13	16	20	17			
Light concrete	25	32	37	38			
Galvanized iron	23	26	27	25			
Dirty galvanized iron		9	9	9	9	9	9
Aluminum	45	49	52	53			
Steel	29	31	34	35			
Granite	10	15	20	22			
Asbestos cement		35	43	45	44	41	37
Weathered wood	9	11	8	10			
Weathered asphalt		9	10	11	11	11	11
Basalt	5	6	7	6			

quite readily with pyrotechnic illuminants, should be adequate to detect and identify objects subtending approximately 5 minutes of visual arc against a terrain background, provided the contrast is greater than 0.1. When the target and its background are illuminated by the same light source, this contrast will (as is true for daylight illumination) depend on the reflectance values for the target and background. Values for typical materials which might be found in the field are given in Table 4-2.

#### 4-4.2 VISIBILITY OF SIGNALS

The requirements for visibility of a signal vary considerably from one application to another. It is not always possible, nor necessary, to provide a signal which is visible at extreme ranges. However, it is desired that a signal produce the maximum visual effect over as long a distance as possible and, in some cases, for as long a period as possible. In addition, it is often necessary to modify signal performance to meet practical size and weight restrictions. These restrictions are

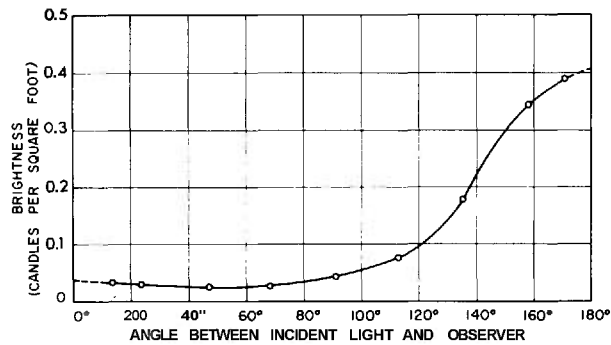

Figure 4-5. Effect of Direction of Illumination on the Luminance of a Smoke Column

extremely important for signals carried aboard aircraft or submarines.

#### 4-4.2.1 Visibility of Smoke Clouds

The visibility of a relatively small dense smoke cloud, such as would be produced as a signal, depends on the ability of the smoke particles to scatter light, or reflect by multiple scattering, in the direction of the observer. Factors which determine, to a large extent, the visibility of a smoke cloud include: (1) illumination of the smoke cloud, and (2) contrast of the cloud against a background.

The effective brightness of the cloud depends on the relative location of the observer and cloud, as well as the intensity and direction of the incident light. This effect is indicated in Figure 4-5 for a relatively dilute, laboratory smoke column. These results, due to the tendency toward forward scattering, indicate that a smoke column is many times as bright in the direction of the sun as it is opposite to the sun. The effect of the relative direction of the sun and smoke is also illustrated in Figure 4-6 where, as expected, the time of discovery is the least when the relative positions result in a maximum cloud brightness. Color of a relatively dense cloud results from multiple scattering and absorption. The color intensity in a dilute cloud may be less because of the reduced multiple-scattering efficiency. If the particles making up the cloud are the wrong size (too small, normally), the color produced may be changed and/or suppressed. The apparent color of the cloud will change with distance and, near the limit

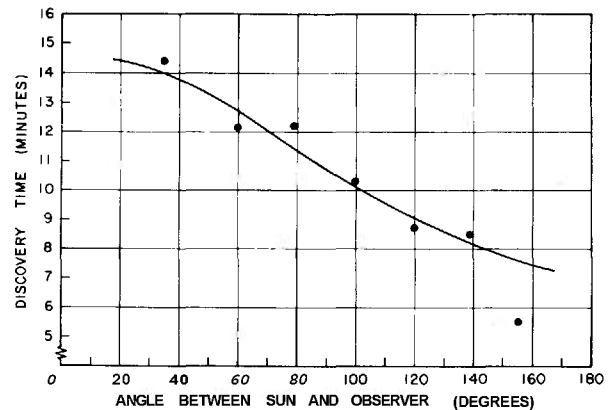

Figure 4-6. Effect of Relative Direction of Sun and Smoke on Time of Discovery

of visibility, will be effectively the same color as the horizon.

#### 4-4.2.2 Visibility of Light Sources

Factors which influence the visibility of a light source are essentially the same as for any other object. The visibility of an illuminated visual angle of approximately one degree or less is dependent principally upon the total light emitted by the area. For a steady point source:

$$F = \frac{C}{X^2} = 3.5 \times 10^{-9} H^{1/2} \text{ lumens/cm}^2 \quad (4-12)$$

where  $F$  is the threshold value of flux density (in lumens per square centimeter),  $C$  is the threshold intensity of the source (in candles),  $X$  is the distance from source to observer (in centimeters), and  $H$  is the background brightness (in candles per square centimeter). The illumination produced at the observer's eye is reduced because of atmospheric attenuation in accordance with the following equation:

$$E_x = \frac{I_o}{X^2} \exp \left[ -3.912 \left( \frac{X}{X_R} \right) \right] \quad (4-13)$$

where  $I_o$  is the intensity of the source and  $X_R$  is the meteorological range. This equation is valid only when  $X$  is large enough that the light may be considered as a point source. The maximum angular size of the light source, which can be considered as a point source, varies with the adaptation brightness as given in Table 4-3.

**TABLE 4-3**  
**MAXIMUM ANGULAR SIZE OF LIGHT SOURCE AS A FUNCTION**  
**OF ADAPTATION BRIGHTNESS**

<i>Adaptation brightness</i> (foot-lamberts)	<i>Maximum angular size</i> (minutes of arc)
1,000	0.708
100	0.708
10	0.750
1	0.891
10 <sup>-1</sup>	<b>1.30</b>
	2.82
10 <sup>-3</sup>	6.68
10 <sup>-4</sup>	8.55
10 <sup>-5</sup>	15.0

A flashing point-source light, where the flashes are of short duration (less than 0.2 second), must have, in general, a higher candlepower than a steady light in order to be seen. It has been found that the threshold intensity  $F$ , required for visibility of a light of duration  $t$ , seconds, is given by:<sup>4</sup>

$$Pt_s = F_s (t_s + 0.21) \quad (4-14)$$

where  $F_s$  equals the threshold intensity of a steady light. Thus, when a flash lasts several seconds so that 0.21 is negligible, the threshold is the same as for steady light. However, as shown in Table 4-4, for small values of  $t_s$ , where  $F$  will be larger than  $F_s$ , this is no longer true. These ratios are not changed greatly for candlepowers up to 50 times threshold for flash durations from 0.05 second up to 1.0 or 2.0 seconds.

For situations in which it is not known where a flash will appear in the field of view, the finding time is quite important. The two variables of major importance in the conspicuity (short finding time) of a flashing light of a candlepower well above threshold intensity are: (1) the time interval between flashes  $T$ , and (2) the duration of each flash  $l$ , in seconds. A flashing light is most conspicuous when  $T$  lies between 0.5 and 1.0 second and  $t_s$  is between 0.25 and 0.75 second.<sup>3</sup> Decreasing  $T$  or increasing  $t_s/T$  increases the finding time because of reduction of flicker. If  $t_s$  is below 0.5 second, the average finding time is increased (for

values of  $T$  as low as 1.0 second) because of the lower visibility of short flashes (according to Blondel and Rey). If  $T$  is greater than 1.0 second, the finding time is also longer because the eye may pass over the light location during the off interval. It was found that a light of ten times threshold intensity was almost always located at the first flash while three flashes were needed if the light were only five times the threshold.

The effect of selective transmission by some types of atmosphere is also important when considering colored lights. Table 4-5 indicates the magnitude of selective absorption of components of sunlight by the atmosphere.

#### 4-4.3 ESTIMATION OF VISIBILITY

The estimation of visibility can be simplified by the use of nomographic visibility charts prepared for this purpose. A chart for circular targets, which has been adapted from the more complete charts available, is given in Figure 4-7. To use this chart for determining visibility along a horizontal path, a straightedge is laid across the chart in such a manner that it connects the value of the inherent contrast between the object and its background with the value of the sky-background brightness ratio (this sky-background ratio is unity if the background of the target is the horizon sky), extended to intersect the zero liminal target distance line. The straightedge is then re-located so that it connects this point with the

**TABLE 4-4**  
**VISIBILITY OF FLASHING LIGHT COMPARED TO STEADY LIGHT**

<i>Flash Duration,</i> <b>seconds</b>	<i>Ratio of Flashing Light</i> <i>to Steady Light</i>
1.0	1.2
0.5	1.4
0.4	1.5
0.3	1.7
0.2	2.0
0.1	3.1
0.05	5.2
0.025	9.4
0.01	22.0

**TABLE 4-5**  
**ABSORPTION OF SUNLIGHT BY ATMOSPHERE**

<i>Wavelength, Angstroms</i>	<i>Percentage Transmitted</i>
4000	47.5
4500	55.3
5000	62.4
6000	68.2
7000	75.6
8000	80.1

These figures represent the relative transmission for the different wavelengths during the day under average clear conditions with the sun at the zenith, and they may vary greatly under other conditions. It must be remembered that a light signal can be seen at a much greater distance than the distance at which its color can definitely be distinguished.

value for the meteorological range. The intersection of the straightedge and the curve for the correct general illumination level locates the liminal target distance.

The procedure for estimating the visibility for slant paths is somewhat more complicated, especially if the atmosphere is stratified. If no optically dissimilar strata are present, the optical slant range can be determined in the same manner as the visual range, along a horizontal path. The actual slant range can then be approximated by the use of Equation 4-18 or Figure 4-3. Because the slant range is normally greater than the optical slant range, the effective area of the target is less than its actual area and the predicted slant range will be high. A better value can be obtained, if an effective area

$\bar{A}$  can be calculated, for targets which subtend a small angle at the observer's eye, by the equation :

$$\bar{A} = \left( \frac{\bar{R}}{R} \right)^2 (A \sin \Theta) \quad (4-15)$$

where  $\bar{R}$  is the first approximation of the optical slant range estimated by use of the nomograph,  $R$  is the corresponding slant range for a sighting path which makes an angle  $\Theta$  with the ground, and  $A$  is the area of the target. This value for  $\bar{A}$  is now used to calculate a better value for the optical slant range  $\bar{R}$  and corresponding slant range  $R$ .

The nomographs are also useful when stratification of the atmosphere causes an effective discontinuity in the meteorological range-altitude rela-



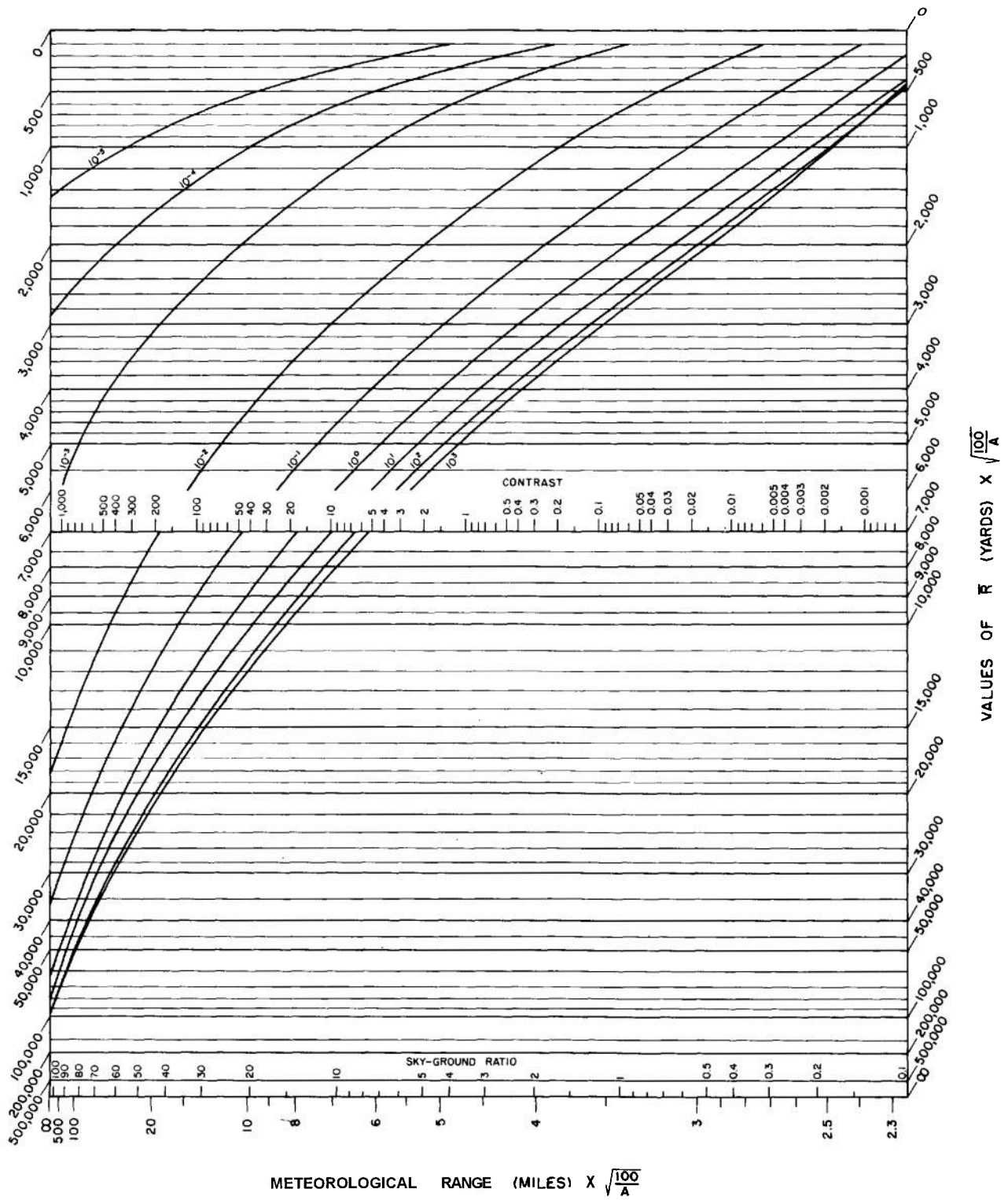

Figure 4-7. Visibility Nomograph

TABLE 4-6  
SKY BRIGHTNESS

<i>Ambient Condition</i>	<i>Brightness, millilamberts</i>
Hazy*	10,000
Clear	1,000
Light Overcast	100
Heavy Overcast	10
Twilight	1
Deep Twilight	0.1
Full Moon	0.01
Quarter Moon	0.001
Starlight	0.0001
Overcast Starlight	0.00001

\* The maximum brightness condition which is likely to be encountered is that of the sky on a slightly hazy day at noon.<sup>6</sup>

TABLE 4-7  
SKY-GROUND RATIO

<i>Sky Condition</i>	<i>Ground Condition</i>	<i>Sky-Ground Ratio</i>
Overcast	Fresh Snow	1
Overcast	Desert	7
Overcast	Forest	25
Clear	Fresh Snow	0.2
Clear	Desert	1.4
Clear	Forest	5

tionship. Let it be assumed, for example, that there is a ground haze which has a top at 5000 feet, and that the meteorological range is five times greater above the haze boundary than below it. For this type of visibility problem, a line is constructed on the optical slant range diagram, Figure 4-3, from the origin to the intersection of the curve for the desired viewing angle  $\Theta$ , with the dashed line representing the true altitude of 5000 feet. A second curve (which has five times the slope of the original curve) is drawn starting at this point. The relationship between  $\bar{R}$ , the optical slant range, and  $R$ , the slant range, follows the resultant curve. If the actual boundary of the ground haze is diffuse, the sharp change in slope can be rounded

off. Because of the problems involved, the estimation of slant ranges is less satisfactory than the estimation of horizontal range. Where experimental values are not available, typical values for the sky brightness are given in Table 4-6 for various ambient conditions. Typical values for the sky-ground ratio are given in Table 4-7.

It is to be noted that the nomograph predicts a distance at which the target is liminally visible. If the contrast value is divided by two before using the nomograph, the result obtained is the sighting range, the distance at which the object can be seen with threshold confidence. For the object to be easily seen, the contrast values should be divided by at least four.

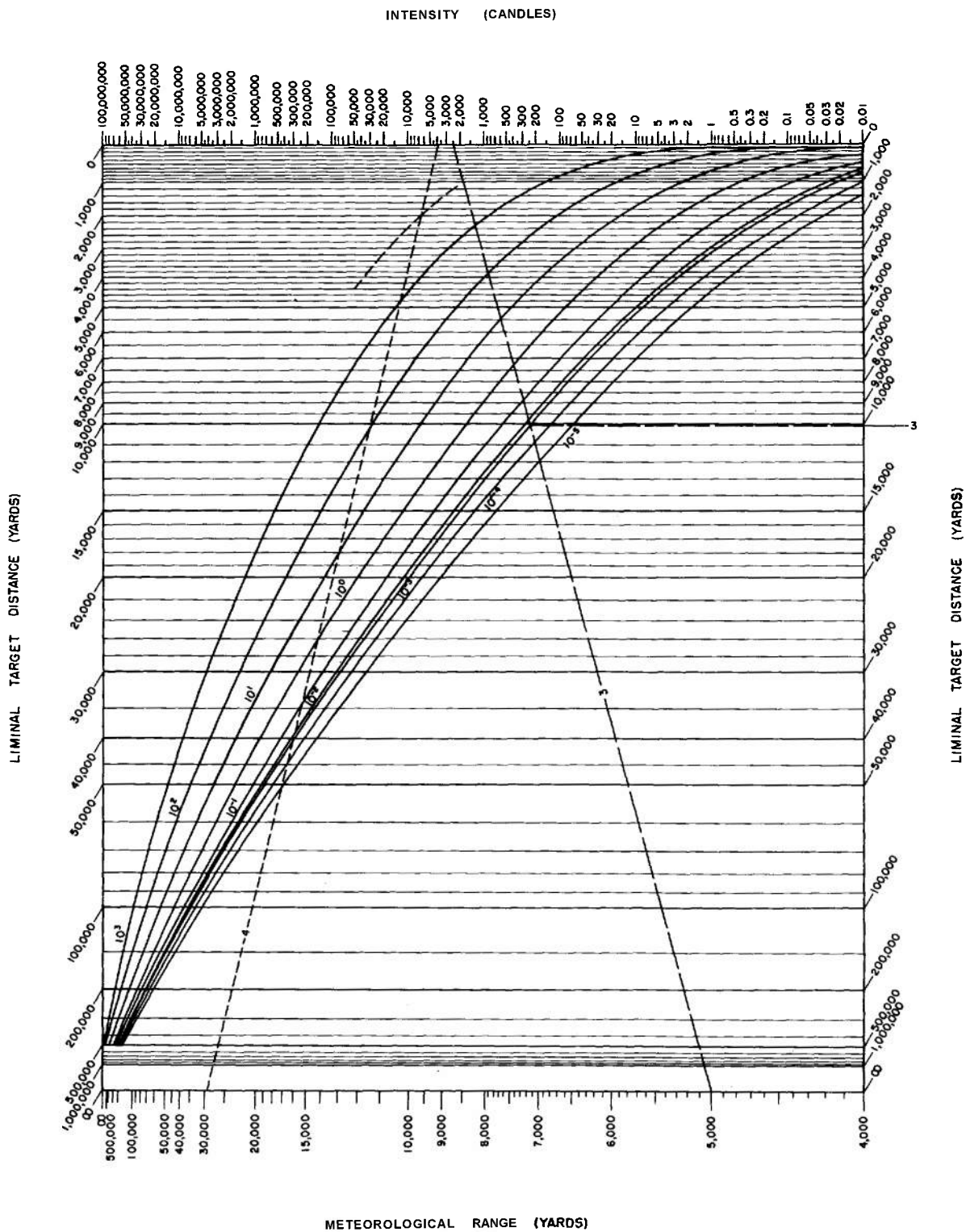

Figure 4-8. Visibility Nomograph for Signal Lights

**TABLE 4-8**  
**INCREASE IN ILLUMINATION REQUIRED FOR**  
**POSITIVE RECOGNITION**

<i>Field Factor Applied to Threshold Candlepower</i>	<i>Detectibility of Light Source</i>
1	Light source difficult to find even if location is known.
2.5-5	Light source moderately difficult to find if location is approximately known and observer is on steady platform and has long time for search.
5-10	Light source easy to find under circumstances above.
20-30	Light source easy to find under reasonable circumstances at night, for example, search field no greater than 100 degrees, observer can give his full attention. Difficult to find in daytime unless observer knows where to look.
100-150	Light source can be found under strenuous circumstances at night, and under most circumstances in the daytime if the search field is not too large.

Square objects are as visible as circular objects of the same area. Objects of other shapes are, in general, less visible.

Figure 4-8 is a visibility chart for predicting the range at which signal lamps and other point sources of light will be liminally visible. To use this chart, a straightedge is placed across the chart so that it connects the meteorological range with the intensity of the light source. The intersection of this straight line with the curve for the proper sky brightness level is the liminal target distance. For signaling purposes at this distance where positive recognition is required, the illumination value should be increased as indicated in Table 4-8.

#### 4-4.4 ILLUSTRATIVE EXAMPLES

1.a. The distance at which a uniform circular target of 100 square feet with a brightness of 10

foot-lamberts will be liminally visible on a clear day, when the meteorological range is 20,000 yards, can be estimated in the following manner:

As sky brightness on clear day is approximately 1000 foot-lamberts, the contrast of target against sky as background is:

$$\frac{10-1000}{1000} = -.99$$

The sky-ground ratio is 1.0 since the object is being viewed against sky. To obtain liminal target distance from nomograph, connect (as shown in Figure 4-9) with a straightedge a sky-ground ratio of 1.0 with a contrast of 0.99 and mark intersection of straightedge with the zero liminal distance line. Connect this point with the meteorological range of 20,000 yards. The liminal target distance is read where this straight line intersects

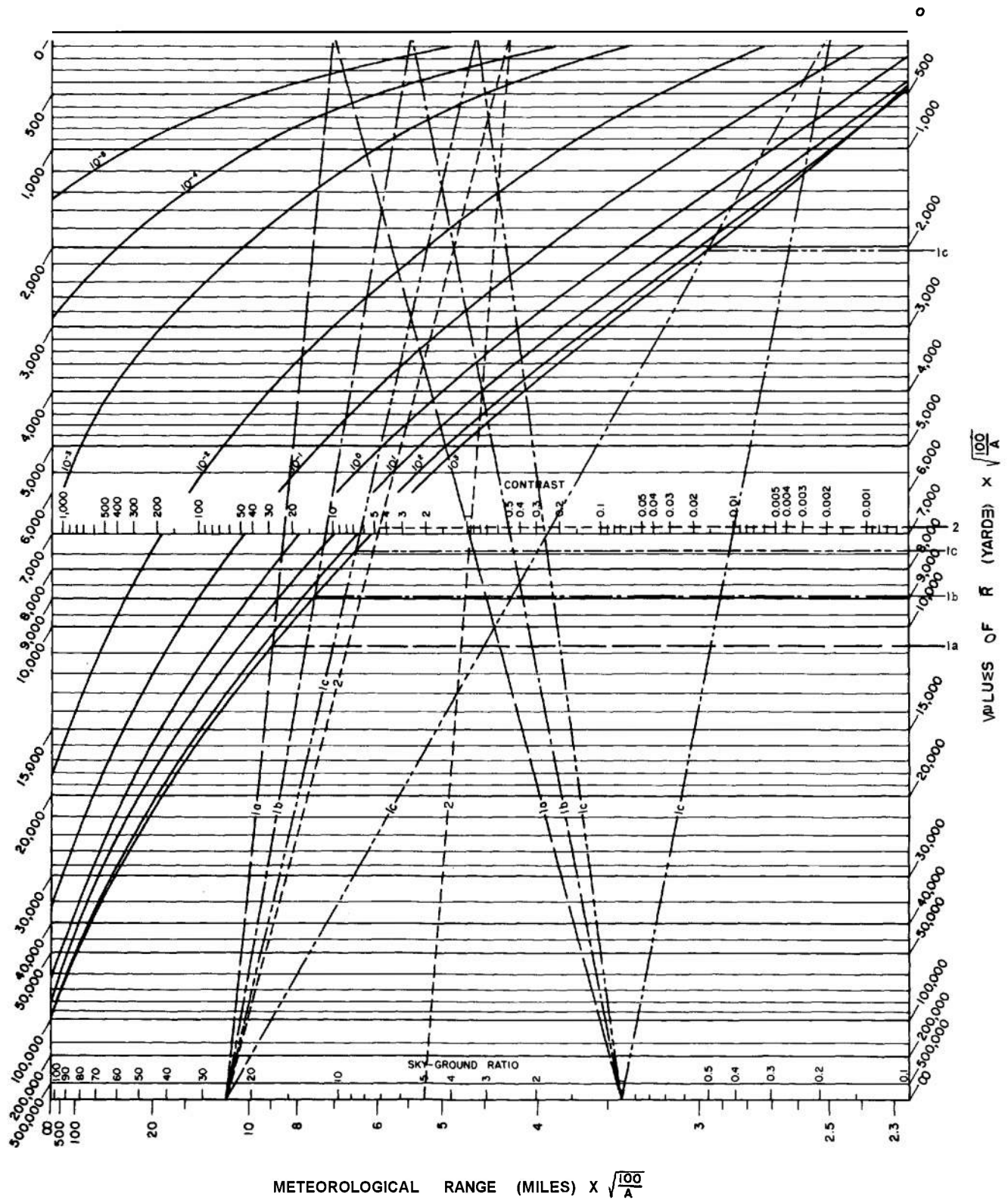

Figure 4-9. Visibility Nomograph Showing Calculation

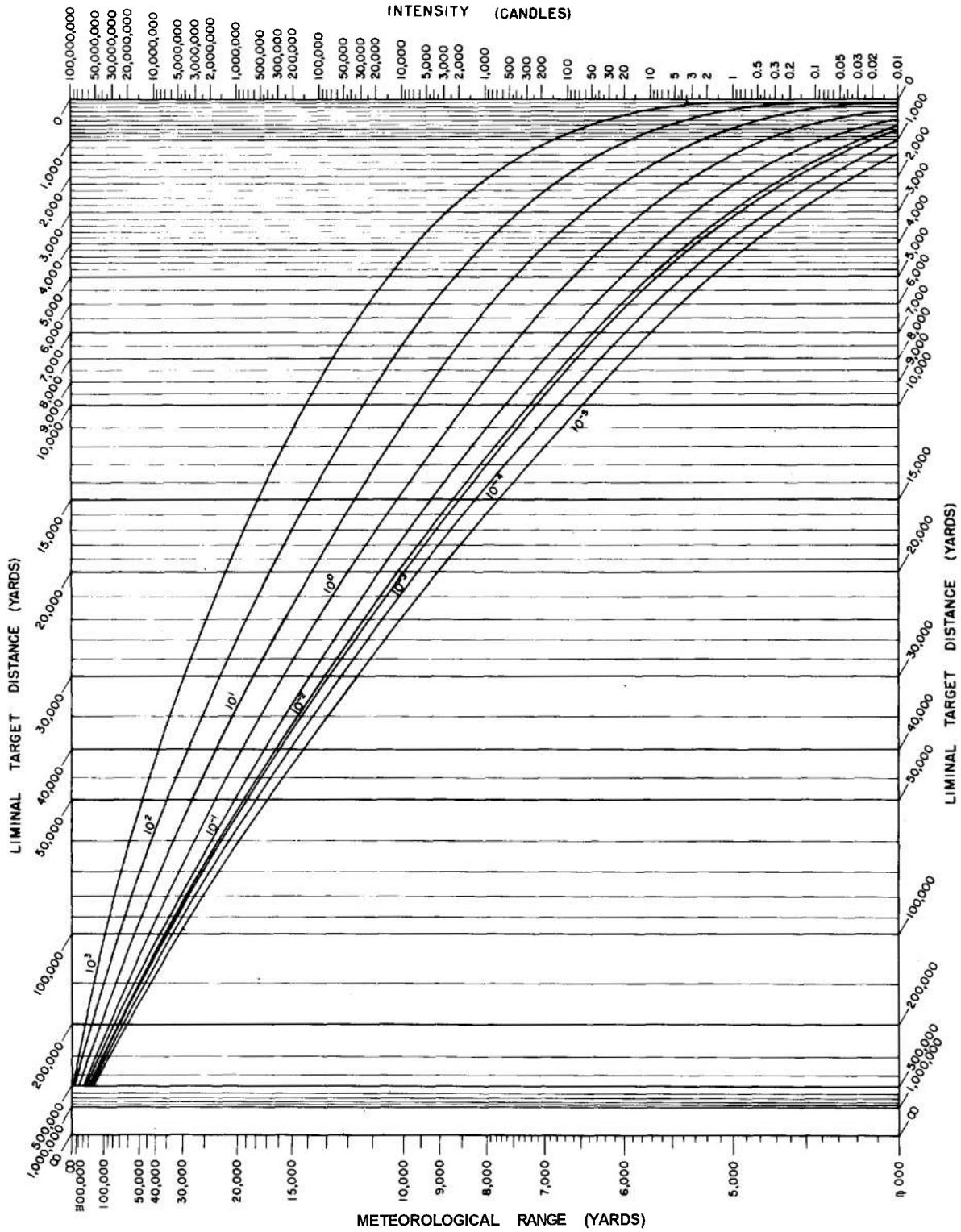

Figure 4-70. Visibility Nomograph for Signal lights Showing Calculation

with the curve for the ambient illumination,  $10^3$  foot-lamberts. The liminal target distance, in this case, is approximately 11,000 yards.

1.b. The sighting range is calculated in the same way except that the effective contrast is:

$$\frac{0.99}{2} = 0.495$$

The sighting range is approximately 9,000 yards.

1.c. The distance at which this target could be seen easily under field conditions:

In order for a target to be seen easily, the contrast values must be divided by at least 4.0. Under difficult field conditions, the contrast value might have to be divided by a number as large as 100. The effective contrast range, therefore, is

$$\text{from } \frac{0.99}{4} = 0.25, \quad \text{to } \frac{0.99}{100} = 0.01$$

and the distance at which the target could be seen easily might be as low as 2,000 yards (2,000 to 7,500 yards).

2. The distance at which the same target would be liminally visible under the same conditions, if it were to be observed against a background having a brightness of 200 foot-lamberts can be calculated. (Since the target and background are both illuminated by the same light source, the reflectance of the background is approximately 20 times that of the target.) In this case, the sky-ground ratio is  $1000/200 = 5.0$ , and the contrast is:

$$\frac{10-200}{200} = -0.95$$

As indicated in Figure 4-9, the determination of the liminal range is the same as outlined for Example 1.a. The liminal distance under these con-

ditions is approximately 6,900 yards. The sighting distance and the distance at which the target could be seen easily would also be calculated in the same manner as illustrated for Example 1.b. and 1.c.

3. The distance at which a signal having an intensity of 2,500 candles would be liminally visible on a foggy night when the meteorological range is 5,000 yards, can be estimated using the signal light nomograph. A straightedge is placed across the nomograph for signal lights so that it connects the meteorological range, 5,000 yards, with the candlepower, 2,500 candles, as shown in Figure 4-10. The liminal distance is given by the intersection of this line with the curve for the illumination level  $10^{-3}$  foot-lamberts.

4. The intensity required for a spotting charge to be seen at 2,000 yards over water and toward a rising sun on a clear day, can be estimated by use of the signal light visibility nomograph. Under these conditions, the illumination level would approach  $10^4$  foot-lamberts. The meteorological range is assumed to be approximately 30,000 yards, a clear day. The intensity required for a light source to be liminally visible under these conditions is obtained from the signal light nomograph by connecting the meteorological range, 20 miles, with the point of intersection of a liminal target distance of 2,000 yards, and the curve for the general illumination level (approximated by dotted curve on Figure 4-10). The intersection of this line with the zero liminal distance line gives the candlepower required, about 4,000 candles. In order to be seen readily under these field conditions, the intensity values should be multiplied (see Table 4-8) by 100 to 150, yielding a required intensity of  $4 \times 10^4$  to  $6 \times 10^4$  candles.<sup>6</sup>

## REFERENCES

1. *Visibility Studies and Some Applications in the Field of Camouflage*, Summary Technical Report of Division 16, National Defense Research Committee, Vol. 2.
2. F. E. Cady and H. B. Dates, *Illuminating Engineering*, 2nd Ed., John Wiley & Sons, N. Y., 1928.
3. R. C. Casperson, H. P. Lenzyck, R. C. Channel, *Visibility Data as it Applies to Pyrotechnics*, Contract DAI-28-017-501-ORD-(P)-1294, Dunlap and Associates, Stamford, Connecticut, 1955.
4. A. Blondel and J. Rey, *Jour de Physique*, Radium, 1911.

5. R. D. Dwiggin, *Factors Affecting Signalling by Visual Methods*, NAVORD **6034**, Bureau of Naval Weapons, Washington, D. C., 1957 (DDC-AD 162 931).
6. R. T. Eckenrode, *The Spotting Technique. II. Effect of Ambient Illumination Spot Intensity and Color: Memory Screen Information*, TS4-**4020**, Frankford Arsenal, Philadelphia, Pa., 1955.
7. R. M. Blount, G. Francis, *Study of Light Sources for Night Aerial Reconnaissance Photography*, Final Report, Contract DA-36-039-**SC-78333**, Denver Research Institute, University of Denver, 1960.
8. *Aerosol and War Gases*, Summary Technical Report of Division 10, National Defense Research Committee.
9. H. L. Greene, W. R. Lane, *Particulate Clouds, Smokes, and Mists*, Van Nostrand Co., London, 1957.



## CHAPTER 5

## PRODUCTION OF HEAT

**5-1 HISTORICAL SUMMARY**<sup>1,5,6,7,8</sup>

The systematic use of incendiaries extends back into ancient times when practically any readily combustible material was used for both offensive and defensive operations. Incendiary-type compositions were used in fireballs, pots, or crude bombs and hurled against the enemy by means of a catapult, or as headings for slings and bow arrows, and other purposes. Some of the earlier combustible materials used included oil, pitch, sulfur, resinous woods, and straw. "Greek fire," an incendiary mixture which probably contained readily flammable substances such as pitch, resin and petroleum, along with quicklime and sulfur, was used in the 17th century against ships, tents, barricades, cities, and personnel. It was especially valuable as an incendiary because it was difficult to extinguish since as water reacted with the quicklime and also spread the petroleum. These types of incendiaries were of definite value in all of the wars fought during the Middle Ages and their importance was not diminished until gunpowder was introduced in the 15th century.

During the 16th, 17th, and 18th centuries, the basic ingredients in incendiary mixtures continued to be sulfur and saltpeter to which were added a number of flammable materials such as resin, pitch, tallow, beeswax, linseed oil, and turpentine. For many years the recognized incendiary projectiles were known as "carcasses." In their earliest form they consisted of cylindrical bags or containers of canvas coated with pitch and bound with iron hoops. The name was suggested because of the likeness of these iron hoops to the ribs of a corpse. Later, their shape became spherical; however, their filling remained the same—a mixture of saltpeter, sulfur, resin, antimony sulphide, and tallow—until carcasses became obsolete toward the end of the 18th century.

Rockets with incendiary charges were em-

ployed by the British in the American Revolution as well as by the armies involved in the many European conflicts of the 19th century. The United States Army had incendiary items of ordnance issue in the early part of the 19th century. During the American Civil War, the incendiary projectiles developed by the Union Army and fired against Vicksburg, Charleston, and Petersburg were of limited value. A flammable liquid was also developed which could be used with a flame thrower. These flame throwers reached Bermuda Hundred, Virginia, early in 1865, and may have been used in later battles of the Civil War."

In general, however, from the beginning of modern times down to World War I, incendiaries were not extensively used due to the increase in battle distances, resulting from the introduction of firearms. In addition, the defensive use of armor and earthworks left little material that would burn on the battlefields. These problems were not solved until the advent of the World War I.

While both the French and German Armies had developed incendiary artillery projectiles before World War I, these projectiles were not used to any extent in the early days of the war, probably because they were ineffective against military targets. The first incendiary munitions used in this war evidently were incendiary bullets and antiaircraft artillery projectiles directed against observation balloons, and flame projectors against ground troops. These devices, along with incendiary bombing from aircraft, were first used by the Germans in 1915.

Intensive research and development programs were established by all the principal belligerents in order to obtain improved incendiary munitions. White phosphorus was effective against

\* W. D. Miles, "The Civil War," Part I, *Chemistry and Engineering News*, Vol. 39, No. 14, April 3, 1961.

readily combustible material such as balloons. It was also very effective against personnel as it produced painful burns and hence caused a demoralizing effect far in excess of the casualties produced. Thermite and modified thermite mixtures were widely employed, especially in connection with an additional incendiary material such as "solidified oil." Other mixtures containing an inorganic oxidizer such as potassium or barium nitrate, barium or lead oxide, or potassium chlorate, and a fuel such as carbon, sulfur, magnesium, aluminum, or organic combustibles, were used in small arms incendiary bullets and with less success in drop bombs.

Solid oil (oil mixtures solidified with colloidal additives) and flame projector liquids consisting of a heavy viscous oil or tar and a more fluid and flammable liquid were also developed but saw only limited use during the war.

In spite of the tactical and strategic possibilities associated with the use of aerial incendiary bombs, only a limited amount of the development work on incendiary munitions was directed toward design of improved munitions of this type. Two general types of aerial incendiary bombs were developed. The first was the relatively large bomb filled with an incendiary mixture, often thermite and solid oil, designed to penetrate and set fire to buildings and heavy construction. The second was the scatter type of incendiary bomb which consisted of incendiary units in a large bomb, or a cluster of small bombs (the latter being the more successful of the two techniques), to start fires over a relatively large area.

The increasing use of military aircraft resulted in an increased interest in small arms incendiary ammunition since the employment of incendiary ammunition was considered to be one of the better ways for destroying aircraft. The first small arms round designed for air-to-air combat was probably the British Pomeroy projectile with a kieselguhr dynamite filler which had both high explosive and incendiary functions, and was very effective against German airships. The earliest incendiary small arms projectile used by the United States, adapted from a British design, employed phosphorus as the incendiary material.

In the period between the two World Wars, only

a limited amount of research and development, was performed on incendiary munitions in the United States. The white phosphorus filling for caliber .30 incendiary ammunition was replaced with a tracer composition. Development work on incendiary compositions was actively resumed in the United States in 1936.

General interest in small arms incendiary ammunition was renewed during the early years of World War II. The DeWilde-Kaufman bullet, designed in Switzerland by 1939, represented a major step forward in the development of small arms incendiary ammunition in that it would function as desired against realistic targets. To eliminate the serious manufacturing and handling problems associated with this design, it was modified by British scientists to use the U.S.-developed IM-11 incendiary mix. Modifications of the British design were made later by the United States Ordnance Department to improve functioning characteristics and to adapt the design to manufacture by mass production techniques. These modifications, including some changes in the incendiary composition, resulted in the U.S. M1 Incendiary Projectile which played an important role in winning the Battle of Britain by defeating the German air attacks. The development of modified incendiary ammunition, including armor-piercing incendiary ammunition, was started in 1943; however, only a small quantity of these items had been produced by the end of the war.

In the Battle of Britain, the Germans used a 1-kilo magnesium bomb against British cities with great effectiveness. A very effective 4-pound magnesium bomb had been developed by the British; however, the United States did not as yet have a satisfactory incendiary bomb. As a consequence, the British MK-III magnesium bomb was redesigned for mass production. A 4-pound thermite bomb was developed as a substitute for the somewhat superior magnesium bomb and was used in General Doolittle's historic raid on Japan in April 1942. A small 2-pound magnesium bomb was also developed and when used in clusters was considered to be more effective against urban German targets than the heavier incendiaries which had been developed for industrial targets. They were also successful against Japanese industrial targets but

penetrated too far to be highly effective against Japanese dwellings.

The development of a small petroleum incendiary bomb was started and led to the development of the 6-pound napalm bomb which was used with spectacular success in the strategic bombing of Japan. Other petroleum incendiary mixtures were developed, including the IM mixture which contained finely divided magnesium. Against both Europe and Japan, incendiary bombs proved to be very effective weapons, especially when approximately one-fifth of them contained explosive charges to discourage fire fighters.

Flame throwers were first used in the Pacific theater on Corregidor by the Japanese against American troops who were not equipped with the weapon. Due to its proven effectiveness and the development of napalm, it was soon used by the United States for combat operations in all theaters of operation, either as a portable unit or mounted on vehicles.

After World War II, research and development directed toward the improvement of small arms incendiary ammunition were continued. Emphasis was directed toward developing improved ammunition with an increased effectiveness per round against jet planes at higher altitudes. This work proved valuable during the Korean Conflict when small arm incendiaries were used in the air conflict against enemy jet aircraft. Other incendiary weapons, including incendiary bombs and flame throwers, also were used widely and effectively in this conflict by the United Nations forces.

The effort applied in the development of incendiary weapons has resulted in peace-time uses for these weapons. Pyrogel (or goop), which contains finely divided magnesium, and which was used in the IM petroleum incendiary mixture, has been found to aid in the burning out of forest cuttings. The flame thrower is of value in fighting forest fires and in destroying unwanted vegetation. Studies into the causes of death by flame carried out during World War II have directed attention of civilian firemen to unsuspected hazards in fighting fires of various kinds. Also, research on the effectiveness of incendiary ammunition against aircraft has been of value in connection with aircraft fires.

Starters, igniters and first fires, as adjuncts to other pyrotechnic devices, have had a history closely associated with such devices. Information describing the development of early Chinese fire-crackers includes descriptions of fuses containing potassium nitrate (saltpeter), charcoal and sulfur. In the 18th century mixtures of potassium nitrate, sulfur, charcoal, and iron filings were widely used for pyrotechnic purposes. They were readily ignited and for this purpose a type of quickmatch was employed.

The quickmatch was made from cotton thread or string, moistened with vinegar or brandy and coated with a mixture consisting of 16 parts potassium nitrate, 3 parts charcoal and 1 part sulfur. The mixture was worked into the thread by hand, after which it was dried and cut into suitable lengths. It was then connected to the pyrotechnic device and used as its igniter.

At the beginning of the 19th century phosphorus-tipped sticks, that could be readily ignited by friction, were made available and were the forerunner of present day matches.

Friction starters were developed later in the 19th century. These employed as a bead a mixture of potassium chlorate and sugar with gum arabic as a binder. In the form of matches, these were ignited by drawing them through a folded piece of sandpaper.

Typical pyrotechnic munitions in the 19th century consisted of rockets, flares, and fireballs which could be ignited by a mixture of potassium nitrate, sulfur, and arsenic sulfide, which, in turn, was ignited by a quickmatch.

During World War I, pyrotechnic munitions were developed which used compositions more difficult to ignite than earlier compositions. In the period between World War I and World War II, limited effort was made to produce more satisfactory ignition mixtures for pyrotechnic munitions. A considerable part of this effort was directed toward the development of satisfactory starter mixtures for HC smoke mixtures and for thermite-type incendiaries. During World War II, emphasis was again directed, mainly, toward developing compositions which would meet the immediate needs of the troops. A relatively small amount of effort has been expended since World

War 11, particularly in connection with the development of new illuminants.

In addition to their value as a source of heat, the utility of combustion processes as a means for measuring and controlling time intervals was recognized early in history. The ancient Chinese, Greeks, and others used open vessels of oil, crude candles, and similar devices, to ignite either explosives or flammable material at a distance or at some delayed time. In addition to their military applications, such delayed reactions—culminating in the sudden production of fire, smoke, or a minor explosive phenomenon—were an important part of many early religious ceremonies.

The introduction of gunpowder stimulated the development of somewhat more sophisticated delay devices. A string or paper impregnated with an oxidizer and elongated trails of powder were some of the earliest pyrotechnic delay trains. Present quickmatch and firecracker fuses are of this type, however, they are normally used as transfer media rather than timers. Fuses consisting of an ingredient such as black powder, contained in a tubular cover, will burn reliably and at reasonably reproducible burning rates. Safety fuse is of this type. It is a lightly wrapped train of potassium nitrate and black powder burning at a rate of 40 to 120 seconds per yard. The tubular cover now is often impregnated fabric. An effort is usually made to seal against moisture by the use of wax and plastic coatings. The development of these fuses made possible lavish firework displays by crudely timing the sequence of events starting with the propagation of the display into the air followed by a sequence of bursts making up the firework display. In addition, their use provided the necessary time required for safety of the personnel igniting extensive ground displays. Fuses of essentially the same type were also used in connection with the early commercial explosives used in mining and construction.

The use of projectiles containing explosives was started sometime after the introduction of artillery in military operations. Early projectiles were filled with gunpowder and closed with a wooden plug containing a small diameter hole, also filled with powder. This crude fuse was ignited by the propelling charge and burned slowly

until the projectile arrived at or close to the target. Similar crude delay trains were developed for incendiary and other projectiles used in early naval warfare when ships were made of wood. Their purpose was not only to delay functioning until a projectile reached its target, but also to further delay functioning so as to maximize its effectiveness in damaging the enemy ship.

With the development of improved ammunition, more complicated fuse systems with improved reliability and timing accuracy were required. The earliest pyrotechnic delays which were relatively accurate consisted of carefully produced black powder trains or black powder rings. The delay train was used in fuses requiring a set delay while the ring delay was most often used in those items requiring setting immediately before use. In spite of the many problems associated with the use of black powder delay compositions, due mainly to their hygroscopic and corrosive nature, they served as the basis of most pyrotechnic delay trains throughout World War 11.

Burning black powder liberates large amounts of gaseous products which, in most fuse designs, are vented to the atmosphere. In the development of ammunition, especially anti-aircraft ammunition during World War I, it was found that the burning rate of black powder was affected considerably by the rotational speeds of the projectile as well as the varying ambient pressures. Therefore, the development of a more satisfactory fuse powder composition was started with a low priority after World War I.

The first nongaseous delay powder—consisting of red lead, silicon, and glycerin (84/15/1)—was developed in 1931. Since this composition burned too fast, slower burning powders containing lead chromate, silicon, and linseed oil (89/10/1) were developed. Lack of personnel and funds, however, prevented a comprehensive, systematic study of the many possible inorganic exothermic reactions before the start of World War 11. As a result, black powder was again widely used in delay elements during World War 11.

In 1942, a comprehensive study of possible gasless delay mixtures was started.<sup>22</sup> While this study was in progress, an urgent need developed for delay powders to be used in the bombs used

in 'skip bombing.' A composition—containing manganese, barium chromate, and sulfur—which had been prepared on a laboratory scale, proved satisfactory in spite of the many difficulties encountered in proceeding from a laboratory to a production scale.<sup>23</sup> The Navy developed, under contract, a delay mixture containing nickel, zirconium, potassium perchlorate, and barium chromate which was used satisfactorily in hand grenades. While these delay powders—developed under wartime conditions—were used operationally, they were far from optimum.<sup>24</sup>

Work after the end of World War II was directed toward the development of more satisfactory gasless delay compositions. The availability of certain powdered metal fuels—e.g., zirconium-nickel alloys and boron—not available earlier, helped in the development of the presently used more satisfactory delay powders.

The development and use of thermal batteries<sup>25,26</sup> required a controllable heat source to melt the electrolyte which is solid at normal temperatures and to activate the battery. Early thermal batteries were activated by weighed quantities of loose heat powder, similar to delay compositions, introduced directly into the battery cases. Slightly improved results were obtained when the battery was divided into compartments and the loose heat powder added to each compartment. Better results were obtained when the heat powder was mixed with inorganic fibers and made into heat paper by conventional paper making technique. ~ ~ \* ~ ~

## 5-2 INTRODUCTION

Pyrotechnic mixtures, when burned, release chemical energy in the form of heat. The heat energy released is used for the production of light, smoke, gas, and sound. Although the heat effects produced in the surroundings by these items are usually incidental and may be undesirable, there are a number of pyrotechnic items in which the production of heat is the primary function.

Pyrotechnic heat producing mixtures can be divided into two general categories, namely :

1. Compositions which produce heat at a high rate :

a. Ignition mixtures which can be initiated

by mechanical, chemical, electrical, or other stimuli of low energy and produce sufficient heat to cause the ignition of other, less sensitive mixtures.

b. First fires, starters, igniters, and similar less sensitive, but relatively easy-to-ignite mixtures, normally activated by the heat produced by another thermal source. The sensitivity level of these mixtures is such that sufficient quantities can be used to supply the heat necessary for ignition of a third mixture or main charge consisting of a propellant or pyrotechnic composition. A similar sequence of ignitions is also common to explosive items.

c. Incendiary mixtures which are used for destructive ignition of combustible materials.

2. Compositions which produce heat at a low rate :

a. Heat powders which produce a controlled amount of heat for applications such as the activation of heat batteries or a controlled evolution of gas, and for other purposes.

b. Delay mixtures which are used to accurately control the time interval between initiation and final functioning.

The rate and control of the heat output from a pyrotechnic mixture, as well as the heat transfer mechanisms involved, are very important in the performance of its function. In this chapter, these characteristics are emphasized as regards existing heat producing pyrotechnic devices.

## 5-3 THEORY

The two important means by which energy can be transferred are heat and work. Both of these energy forms are transient in nature since they exist only when there is an exchange of energy between two systems or a system and its surroundings. If this transfer takes place without a transfer of mass, and not as a result of a temperature difference, the energy is said to have been transferred through the performance of work. If the exchange is due to a temperature difference, the energy is said to have been transferred in the form of heat.

The amount of energy transferred as heat from a burning pyrotechnic mixture depends on: (1) the amount and rate of energy released, (2) the products formed, (3) the temperature reached by

the products, (4) the method by which the energy is transferred, and (5) the characteristics of the material being heated, whether unburned pyrotechnic mixture or other combustible.

### 5-3.1 AMOUNT OF ENERGY RELEASED'

The energy released by the reaction of a pyrotechnic mixture can be calculated by the methods outlined in Chapter 3 (Paragraph 3-2.2.1) of this handbook or can be determined experimentally by bomb calorimetric measurements.

Certain generalizations can be made from the results of these calculations involving metals and oxidizers which might be considered for heat producing mixtures. For a given fuel, the heat evolved per unit-volume of the mixture (calculated from the theoretical density for the mixture) depends on the oxidizer used, as is indicated in Table 5-1 which is a summary of the heat evolved when aluminum reacts with various oxidizing agents. In general, for a given oxidizer action the heat evolved depends on the oxidizer anion in the following decreasing order:

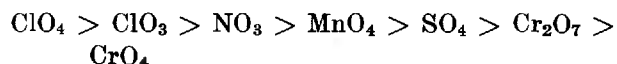

As also shown in Table 5-1 for a given oxidizer anion, copper salts yield more heat than lead compounds and either of these yields more than sodium, potassium, calcium, or barium compounds when reacted with the same fuel. While copper salts appear best, they are not commonly used because of the difficulty involved in their ignition. The reactions are listed in order of the heat evolved in calories per cubic centimeter of mixture; the heat evolved per gram of mixture is also given, for comparison. In each case, the calculated heat of reaction is based on a particular (most common) stoichiometry for the reaction; the indicated values would vary where different stoichiometries are possible. Since the oxidizer exerts the greatest influence on the heat of reaction, the replacement of aluminum with other reducing agents would result in an arrangement similar to that shown in Table 5-1.

The amount of oxygen available from a given amount of oxidizer is the basic criterion upon which oxidizers are judged. Three classes of oxi-

dizers which have been widely used in incendiary compositions are the inorganic nitrates, perchlorates, and peroxides. The total and available oxygen for some of these oxidizers are given in Tables 5-2,<sup>2</sup> 5-3, and 5-4. Many of the potentially good oxidizers listed in these tables contain large quantities of water in their normally occurring crystalline forms. This reduces the available oxygen from a given quantity of oxidizer and can affect burning (as an inert) as well as stability in storage. Approximate decomposition temperatures are also

TABLE 5-1  
HEATS EVOLVED FROM REACTIONS OF  
ALUMINUM AND VARIOUS  
OXIDIZING AGENTS

<i>Reaction</i>	<i>Cal/cc</i>	<i>Cal/g</i>
Al + NaClO <sub>4</sub>	7,000	2,600
Al + NaClO <sub>3</sub>	6,300	2,500
Al + KClO <sub>4</sub>	6,100	2,400
Al + Pb(NO <sub>3</sub> ) <sub>2</sub>	5,800	1,500
Al + KClO <sub>3</sub>	5,400	2,200
Al + PbO <sub>2</sub>	4,900	700
Al + CuSO <sub>4</sub>	4,700	1,400
Al + CuO	4,600	900
Al + NaNO <sub>3</sub>	4,400	1,800
Al + Ba(NO <sub>3</sub> ) <sub>2</sub>	4,200	1,400
Al + PbSO <sub>4</sub>	4,200	800
Al + KNO <sub>3</sub>	4,000	1,800
Al + CaSO <sub>4</sub>	3,800	1,300
Al + KMnO <sub>4</sub>	3,600	1,300
Al + Fe <sub>2</sub> O <sub>3</sub>	3,500	900
Al + MnO <sub>2</sub>	3,400	1,100
Al + BaSO <sub>4</sub>	3,400	900
Al + Fe <sub>3</sub> O <sub>4</sub>	3,400	800
Al + Na <sub>2</sub> SO <sub>4</sub>	3,300	1,200
Al + Pb <sub>3</sub> O <sub>4</sub>	3,300	400
Al + Na <sub>2</sub> O <sub>2</sub>	3,100	1,600
Al + K <sub>2</sub> SO <sub>4</sub>	3,100	1,200
Al + NH <sub>4</sub> NO <sub>3</sub>	3,000	1,600
Al + Na <sub>2</sub> CrO <sub>4</sub>	2,800	1,000
Al + K <sub>2</sub> Cr <sub>2</sub> O <sub>7</sub>	2,800	1,000
Al + BaO <sub>2</sub>	2,600	600
Al + PbO	2,500	300
Al + BaCrO <sub>4</sub>	2,400	600
Al + K <sub>2</sub> CrO <sub>4</sub>	2,200	800

TABLE 5-2  
OXYGEN CONTENT OF VARIOUS NITRATES

Nitrate	Density g/cc	Approx. Decomp. Temp, °C	Oxygen Contained		Oxygen Available	
			g/g	g/cc	g/g	g/cc
Liquid O <sub>2</sub>	1.14	—	1.00	1.14	1.00	1.14
Liquid O <sub>3</sub>	1.71	—	1.00	1.71	1.00	1.71
Aluminum (+H <sub>2</sub> O) <sup>1</sup>	—	130	.77	—	.32	—
Ammonium	1.73	210	.60	1.04	.20	.35
Barium	3.24	600	.37	1.19	.31	.99
Beryllium (+H <sub>2</sub> O) <sup>1</sup>	—	100	.78	—	.39	—
Calcium (+H <sub>2</sub> O) <sup>1</sup>	2.36	560	.59	1.38	.48	1.14
Chromium (+H <sub>2</sub> O) <sup>1</sup>	—	100	.71	—	.32	—
Cobalt (+H <sub>2</sub> O) <sup>1</sup>	—	100	.59	—	.44	—
Copper (+ H <sub>2</sub> O) <sup>1</sup>	—	150	.51	—	.42	—
Iron (Ferric) (+H <sub>2</sub> O) <sup>1</sup>	—	100	.47	—	.39	—
Lead	4.53	470	.29	1.31	.24	1.10
Lithium (+H <sub>2</sub> O) <sup>1</sup>	2.38	260	.69	1.65	.58	1.38
Magnesium (+H <sub>2</sub> O) <sup>1</sup>	—	100	.75	—	.62	—
Manganese	—	130	.54	—	.40	—
Potassium	2.11	400	.47	1.00	.40	.84
Sodium	2.26	350	.56	1.28	.47	1.06
Strontium	2.99	600	.45	1.38	.38	1.13

<sup>1</sup> (H<sub>2</sub>O) indicates that a hydrate of the nitrate is a common form of the salt. All data presented in the table, however, are for the anhydrous salt.

given in these tables. The thermal decomposition of many of the possible oxidizers has been studied in detail.<sup>3</sup>

In Table 5-5, reactions are shown between various metallic and nonmetallic reducing agents, and barium peroxide. The heats evolved from reactions of these materials with other oxidizing agents would generally rank in the same order.

Some of the combinations included in Table 5-5, such as barium peroxide with tin, chromium, and zinc, are so insensitive that the peroxide would decompose before ignition occurred. Conversely, red phosphorus and sulfur with peroxides can be sensitive to the point of spontaneous decomposition and constitute a hazard. The equivalent heat value given in this table is the heat evolved for the reactions, as given in the equations, divided by the number of equivalent weights of reducing agent in the equation. The equivalent heat has been

used as a measure of the reducing power of these compounds.

It should be noted that combustion of liquid hydrocarbon fuels such as gasoline and kerosene, which were widely used as incendiaries during both World War II and the Korean Conflict, results in the evolution of about 10 kilocalories per gram. This is considerably better on a weight basis than for the metal incendiary materials: thermite, 0.8 kilocalories per gram, and magnesium, 0.6 kilocalories per gram. However, the temperature reached by the hydrocarbon-oxygen reaction is less than that reached by incendiaries incorporating metal fuels.

### 5-3.2 HEAT TRANSFER

The efficiency and performance of pyrotechnic devices are considerably influenced by the various modes and rates of heat transfer present through-

**TABLE 5-3**  
**OXYGEN CONTENT OF VARIOUS PERCHLORATES**

<i>Perchlorate</i>	<i>Density</i> <i>g/cc</i>	<i>Approx.</i> <i>Decomp.</i> <i>Temp,</i> <i>°C</i>	<i>Oxygen</i> <i>Contained</i>		<i>Oxygen</i> <i>Available</i>	
			<i>g/g</i>	<i>g/cc</i>	<i>g/g</i>	<i>g/cc</i>
Liquid O <sub>2</sub>	1.14	—	1.00	1.14	1.00	1.14
Liquid O <sub>3</sub>	1.71	—	1.00	1.71	1.00	1.71
Ammonium	1.95	—	0.54	1.06	0.27	0.53
Barium (H <sub>2</sub> O) <sup>1</sup>	—	500	.38	—	.33	—
Cobalt (H <sub>2</sub> O) <sup>1</sup>	3.33	—	.50	1.65	.40	1.34
Copper	—	110	.27	—	.16	—
Iron (H <sub>2</sub> O) <sup>1</sup>	—	—	.62	—	.29	—
Lead (H <sub>2</sub> O) <sup>1</sup>	2.6	100	.31	.99	.24	.63
Lithium (H <sub>2</sub> O) <sup>1</sup>	2.43	410	.60	1.47	.53	1.28
Magnesium (H <sub>2</sub> O) <sup>1</sup>	2.60	—	.57	1.48	.50	<b>1.30</b>
Potassium	2.52	400	.46	1.16	.40	1.02
Sodium (H <sub>2</sub> O) <sup>1</sup>	2.49	480	.52	1.29	.46	1.15

<sup>1</sup> (H<sub>2</sub>O) indicates that a hydrate of the perchlorate is a common form of the salt. All data presented in the table, however, are for the anhydrous salt.

**TABLE 5-4**  
**OXYGEN CONTENT OF VARIOUS OXIDES AND PEROXIDES**

<i>Oxide or Peroxide</i>	<i>Density,</i> <i>g/cc</i>	<i>Approx.</i> <i>Decomp.</i> <i>Temp,</i> <i>°C</i>	<i>Oxygen</i> <i>Contained</i>		<i>Oxygen</i> <i>Available</i>	
			<i>g/g</i>	<i>g/cc</i>	<i>g/g</i>	<i>g/cc</i>
Liquid O <sub>2</sub>	1.14	—	1.00	1.14	1.00	1.14
Liquid O <sub>3</sub>	1.71	—	1.00	1.71	1.00	1.71
Barium Peroxide (H <sub>2</sub> O) <sup>1</sup>	4.96	—	.19	.94	.09	.47
Calcium Peroxide (H <sub>2</sub> O) <sup>1</sup>	—	280	.44	—	.22	—
Chromium Trioxide (H <sub>2</sub> O) <sup>1</sup>	2.7	190	.48	1.30	.24	.65
Iodine Pentoxide	4.80	300	.24	1.15	.24	1.15
Iron (Fe <sub>2</sub> O <sub>3</sub> )	5.12	—	.30	1.54	—	—
Lead Dioxide	9.38	290	.13	1.26	.07	<b>.63</b>
Manganese Trioxide	—	—	.47	—	.23	—
Potassium Peroxide	<b>2.74</b>	—	.29	.61	<b>.14</b>	<b>.30</b>
Sodium Peroxide (H <sub>2</sub> O) <sup>1</sup>	2.81	—	.41	1.15	.20	.58
Strontium Peroxide (H <sub>2</sub> O) <sup>1</sup>	—	—	.27	—	.14	—

<sup>1</sup> (H<sub>2</sub>O) indicates that a hydrate of the peroxide is a common form of this material. All data presented in this table, however, are for the anhydrous form of these peroxides.



**TABLE 5-5**  
**HEAT OF REACTION OF REDUCING AGENTS**  
**WITH BARIUM PEROXIDE**

<i>Equation</i>	<i>Heat of Reaction (Kg-cal)</i>	<i>Equivalent Heat (Kg-cal)</i>
$\text{BaO}_2 + \text{Mg} \rightarrow \text{BaO} + \text{MgO}$	126.7	63.4
$2\text{BaO}_2 + \text{Zr} \rightarrow 2\text{BaO} + \text{ZrO}_2$	219.3	54.8
$3\text{BaO}_2 + 2\text{Al} \rightarrow 3\text{BaO} + \text{Al}_2\text{O}_3$	321.8	53.6
$5\text{BaO}_2 + 2\text{red P} \rightarrow 2\text{BaO} + \text{Ba}_3(\text{PO}_4)_2$	487.6	48.8
$2\text{BaO}_2 + \text{Ti} \rightarrow 2\text{BaO} + \text{TiO}_2$	186.2	46.6
$2\text{BaO}_2 + \text{Si} \rightarrow 2\text{BaO} + \text{SiO}_2$	162.6	40.7
$\text{BaO}_2 + \text{Mn} \rightarrow \text{BaO} + \text{MnO}$	77.1	38.6
$3\text{BaO}_2 + 2\text{Cr} \rightarrow 3\text{BaO} + \text{Cr}_2\text{O}_3$	214.8	35.8
$\text{BaO}_2 + \text{Zn} \rightarrow \text{BaO} + \text{ZnO}$	64.1	32.1
$2\text{BaO}_2 + \text{Sn} \rightarrow 2\text{BaO} + \text{SnO}_2$	99.3	24.8
$5\text{BaO}_2 + \text{CaSi}_2 \rightarrow 5\text{BaO} + \text{CaO} + 2\text{SiO}_2$	236.7	23.7
$3\text{BaO}_2 + 2\text{Fe} \rightarrow 3\text{BaO} + \text{Fe}_2\text{O}_3$	140.3	23.4
$\text{BaO}_2 + \text{Cd} \rightarrow \text{BaO} + \text{CdO}$	45.8	22.9
$3\text{BaO}_2 + \text{W} \rightarrow 3\text{BaO} + \text{WO}_3$	137.5	22.9
$3\text{BaO}_2 + \text{Mo} \rightarrow 3\text{BaO} + \text{MoO}_3$	118.3	19.7
$2\text{BaO}_2 + 2\text{S} \rightarrow \text{BaS} + \text{BaSO}_4$	155.8	19.5
$\text{BaO}_2 + \text{Ni} \rightarrow \text{BaO} + \text{NiO}$	39.0	19.5
$\text{BaO}_2 + \text{Co} \rightarrow \text{BaO} + \text{CoO}$	38.1	19.1
$3\text{BaO}_2 + 2\text{Sb} \rightarrow 3\text{BaO} + \text{Sb}_2\text{O}_3$	107.8	18.0
$3\text{BaO}_2 + 2\text{Bi} \rightarrow 3\text{BaO} + \text{Bi}_2\text{O}_3$	78.9	13.2
$\text{BaO}_2 + \text{Cu} \rightarrow \text{BaO} + \text{CuO}$	16.4	8.2
$2\text{BaO}_2 + 2\text{Se} \rightarrow \text{BaSe} + \text{BaSeO}_4$	54.3	6.8

out the system. Although extremely complicated mechanisms exist in some cases, a knowledge of the problems involved is important to the improvement of pyrotechnic compositions and hardware design.

Heat is transferred by one or by a combination of the three basic mechanisms: conduction, convection, and radiation. During propagative burning, only one of these modes is controlling.

### 5-3.2.1 Conduction

In conduction, the heat energy is transferred by molecular motion and free electrons. Materials like the metals, which are good conductors of heat, have a well-ordered crystalline structure and are rich in free electrons. All materials conduct heat to some extent. In liquids and gases, the amount

transferred by this method is usually small when compared with the amount transferred by other means. The rate of heat transfer  $q$ , at which heat flows across an area  $A$ , is given by:

$$q = -kA \frac{dt}{dx} \quad (5-1)$$

where  $k$  is the thermal conductivity, and  $dt/dx$  is the temperature gradient at the point of interest. The rate expressions for a general three-dimensional case are more complex.

The thermal conductivity of the pyrotechnic mixture has been shown to influence the burning rate due to a preheating of the unburned composition (Paragraph 6-3.5). The amount of preheating is usually a function of the metal content of the mixture due to its higher thermal conductivity.

The degree of consolidation also affects the rate of heat transfer. The heat conduction along solid flares has been measured<sup>3</sup> by imbedding thermocouples in the composition at the time of compaction. From these data it was possible to construct a model for relating the instantaneous temperature at a point in the flare to that of the reaction zone.

Conduction heat transfer as well as radiation influence the on-target combustion efficiency of certain types of incendiary mixtures. The rate of energy release of the fuel-oxidant reaction, intimacy of contact, and chemical-physical properties of the target influence the heat transfer rate.

Heat is transferred by conduction as well as by the other modes in ignition trains, delays and heat powders, and should be taken into consideration in establishing design criteria.

### 5-3.2.2 Convection and Radiation

Convective and radiative modes of heat transfer in pyrotechnics are more closely associated with post-combustion phenomena. Convective heat transfer effects are less important and will only be mentioned briefly. Transfer of heat energy by convection results from the gross movement of the fluid transfer medium. The amount  $q$  of heat transferred by convection can be expressed by the general equation:

$$q = hA(\Delta T) \quad (5-2)$$

where  $h$  is the heat transfer coefficient, which may be a complex function of a large number of properties including those relating to the fluid motion;  $A$  is the cross-sectional area; and  $\Delta T$  is the temperature difference. Convective heat transfer effects may exert an influence on the luminous output and efficiency of flame plumes by moving oxygen into the combustion area and/or by cooling. These effects are usually slight and their measurement extremely complicated.

Heat transfer by radiation does not require a transfer medium. The amount of energy emitted from a heated surface which has blackbody characteristics is:

$$q = \sigma AT^4 \quad (5-3)$$

where  $\sigma$  is the Stefan-Boltzmann constant,  $A$  is

the area of the emitting surface, and  $T$  the absolute temperature. A graybody, or nonselective radiator, is one in which its emissivity is independent of the wavelength. At a given temperature, the amount of energy emitted per unit area at any wavelength is less than that from a blackbody. The net heat exchange between two bodies in which both the hot and cold body are graybodies is:

$$q_{net} = q_h - q_c \quad (5-4)$$

where the net heat exchange is the difference between the amount of heat  $q$  transferred by radiation to the cooler body, less the amount  $q$  transferred from the cooler to the hotter body. This may be written also as:

$$q_{net} = E_h \alpha_c F_{h \rightarrow c} A_h \sigma T_h^4 - E_c \alpha_h F_{c \rightarrow h} A_c \sigma T_c^4 \quad (5-5)$$

or by application of the reciprocity theorem:

$$q_{net} = E_h \alpha_c F_{h \rightarrow c} A_h \sigma (T_h^4 - T_c^4) - E_c \alpha_h F_{c \rightarrow h} A_c \sigma (T_h^4 - T_c^4) \quad (5-6)$$

where  $E$  is the emissivity,  $\alpha$  is the absorptivity,  $F$  is the fraction of the energy emitted by a radiating body that is absorbed by the absorbing body,  $A$  is the area of the emitting surface,  $\sigma$  is the Stefan-Boltzmann constant, and  $T$  is the absolute temperature. The subscripts  $h$  refer to the hotter body, and the subscripts  $c$  refer to the cooler body.

Radiation heat transfer is important in post-combustion phenomena of pyrotechnic flares since it is the primary mechanism by which heat is returned to the reaction zone. This feedback is important to the maintaining of propagative burning and maximum possible efficiencies in these type reactions. As already indicated, radiative heat transfer mechanisms also influence the efficiency of certain types incendiary mixtures. In this case, it is expedient to produce radiating species which will be readily absorbed by the target.

### 5-3.3 HEAT EFFECTS

If heat is transferred to or from a system, the temperature of the system usually changes. The magnitude of the temperature change depends on the mass of a system and its heat capacity. These quantities are discussed in Paragraph 3-2.1. Transfer of heat may also cause phase changes such as crystalline transition, melting (or freezing), vap-

orization (or sublimation), and dissociation. The energy involved in these changes in state may be large in comparison with those involved in the raising or lowering of the temperature of the system. Changes in state brought about by the absorption of heat may be extremely important in initiating combustion since the fuel and oxidizer must in some cases be converted into the gaseous state for the combustion process to proceed.

#### 5-4 INCENDIARIES

Incendiary devices are used to initiate destructive fires in a large variety of targets. While aircraft, buildings, industrial installations, ammunition, and fuel dumps are among the principal targets for incendiary attack, incendiaries have proved to be effective against personnel, armored vehicles, and tanks. In many cases, the psychological fear of fire increases the effectiveness of an incendiary attack as personnel may abandon relatively safe positions and vehicles thus exposing themselves to the action of other weapons.

Incendiary compositions and incendiary devices can be classified in many ways depending on their composition and use. In this handbook, incendiaries are grouped into three large classes based on their use:

1. Small arms incendiary ammunition used primarily against aircraft and fuel dumps.
2. Other incendiary munitions including bombs, grenades, mortar and artillery projectiles; to initiate fires in buildings, industrial installations, ammunition, fuel dumps and other targets in the combat zone, in areas behind the combat area, and in the zone of interior of the enemy.
3. Special incendiary devices used for covert purposes, in connection with guerrilla operations, and for the destruction of material and documents.

##### 5-4.1 SMALL ARMS INCENDIARY AMMUNITION<sup>6</sup>

Small arms incendiaries are used primarily for starting destructive fires in aircraft fuels. The burst produced serves, basically, as an ignition source for the fuel carried by the aircraft since it is unlikely that a small arms incendiary burst of sufficient intensity or duration would weaken air-

craft structures. It is important that the bullet or projectile provide a hole in a self-sealing fuel tank so that some fuel is spilled and ignited by the burning incendiary material. This emphasizes the importance of widespread distribution of burning particles and long burst duration. Most small arms incendiary compositions are mixtures of metal, or metal alloys, and an oxidizing compound. These mixtures when initiated, in contrast to some other incendiaries, usually burn rapidly; often with explosive violence. Unfuzed incendiary rounds up to 20 mm sizes are usually initiated by the heat produced from the crushing of the metal nose by impact while 20 mm and larger sizes are provided with fuzes which are initiated by impact.

The functioning of a thin metal nose, nonfuzed, small arms incendiary bullet can be divided into three separate stages:

1. Initiation of incendiary compositions by bullet impact on target.
2. Rapid burning and heating of the composition and its combustion products until a maximum temperature is reached and the burning contents burst from the bullet jacket.
3. Cooling of the products from their maximum temperature to the minimum effective temperature, i.e., the minimum temperature necessary for fuel ignition.

The chain of reaction with fuzed incendiary rounds, such as 20 mm, is similar to that described except that the sensitive fuze starts ignition upon impact.

The degree of penetration before initiation of the burst is determined, primarily, by the sensitivity of the bullet and its ability to carry through target areas to the interior of the aircraft. The physical size of the incendiary burst produced also affects its burst location in the aircraft. This has been found to be especially important in the case of sparking-type incendiary compositions since they spread throughout a target area and produce a very large and effective burst volume.

For many incendiary compositions, for which the burning time is very short, the effective burst duration is the time required for the products to cool to the minimum temperature required for fuel ignition. In other mixtures which contain relatively

**TABLE 5-6  
SUMMARY OF LIMITS OF FLAMMABILITY OF VARIOUS GASES  
AND VAPORS IN AIR AND IN OXYGEN**

Gas or Vapor	Limits in Air, %				Limits in Oxygen, %				Oxygen Percentage Below Which No Mixture is Flammable	
	Lower		Higher		Lower		Higher		Nitrogen as Diluent of Air	Carbon dioxide as Diluent of Air
<b>HYDROCARBONS</b>										
Methane.....	5.3	(5.0)	14	15	5.1	.....	61	.....	12.1	14.6
Ethane.....	3.0	.....	12.5	15	3.0	.....	66	.....	11.0	13.4
Propane.....	2.2	.....	9.5	.....	2.3	.....	55	.....	11.1	14.3
Butane.....	1.9	.....	8.5	.....	1.8	.....	49	.....	12.1	14.5
Isobutane.....	1.8	.....	8.4	.....	1.8	.....	48	.....	12.0	14.8
Pentane.....	1.5	1.4	7.8	.....	.....	.....	.....	.....	12.1	14.4
Isopentane.....	1.4	.....	7.6	.....	.....	.....	.....	.....	.....	.....
2-2 Dimethyl propane.....	1.4	.....	7.5	.....	.....	.....	.....	.....	.....	.....
Hexane.....	1.2	.....	7.5	.....	.....	.....	.....	.....	11.0	14.5
Dimethyl butane.....	1.2	.....	7.0	.....	.....	.....	.....	.....	.....	.....
2-Methyl pentane.....	1.2	.....	7.0	.....	.....	.....	.....	.....	.....	.....
Heptane.....	1.2	1.1	6.7	.....	.....	.....	.....	.....	.....	.....
2-3 Dimethyl pentane.....	1.1	.....	6.7	.....	.....	.....	.....	.....	.....	.....
Octane.....	1.0	.....	.....	.....	.....	.....	.....	.....	.....	.....
Iso-octane.....	1.1	1.0	.....	6.0	.....	.....	.....	.....	.....	.....
Nonane.....	.....	.8	.....	.....	.....	.....	.....	.....	.....	.....
Tetramethyl pentane.....	.8	.....	4.9	.....	.....	.....	.....	.....	.....	.....
Diethyl pentane.....	.....	.7	.....	5.7	.....	.....	.....	.....	.....	.....
Decane.....	.8	.....	.....	5.4	.....	.....	.....	.....	.....	.....
Ethylene.....	3.1	2.7	32	34	3.0	.....	80	.....	10.0	14.7
Propylene.....	2.4	2.0	10.3	11	2.1	.....	53	.....	11.5	14.1
Butylene.....	2.0	.....	9.6	.....	.....	.....	.....	.....	.....	.....
Butene-1.....	1.6	.....	9.3	.....	1.8	.....	58	.....	11.6	14.0
Butene-2.....	1.8	.....	9.7	.....	1.7	.....	55	.....	.....	.....
Isobutylene.....	1.8	.....	8.8	.....	.....	.....	.....	.....	.....	.....
n-n-Amylene.....	1.5	1.4	8.7	.....	.....	.....	.....	.....	.....	.....
Butadiene.....	2.0	.....	11.5	.....	.....	.....	.....	.....	10.4	13.1
Acetylene.....	2.5	(2.3)	.....	81	.....	.....	.....	.....	.....	.....
Benzene.....	1.4	.....	7.1	.....	.....	.....	.....	.....	11.2	13.9
Toluene.....	1.4	1.3	.....	6.7	.....	.....	.....	.....	.....	.....
o-Xylene.....	.....	1.0	.....	6.0	.....	.....	.....	.....	.....	.....
Ethylbenzene.....	1.0	.....	.....	.....	.....	.....	.....	.....	.....	.....
Styrene.....	.....	1.1	.....	6.1	.....	.....	.....	.....	.....	.....
Butylbenzene.....	.....	.8	.....	5.8	.....	.....	.....	.....	.....	.....
Naphthalene.....	.....	.9	.....	5.9	.....	.....	.....	.....	.....	.....
Cyclopropane.....	2.4	.....	10.4	.....	2.5	.....	60	.....	11.7	13.0
Ethyl cyclobutane.....	1.2	.....	7.7	.....	.....	.....	.....	.....	.....	.....
Ethyl cyclopentane.....	1.1	.....	6.7	.....	.....	.....	.....	.....	.....	.....
Cyclohexane.....	1.3	.....	8	.....	.....	.....	.....	.....	.....	.....
Methyl cyclohexane.....	1.2	.....	.....	.....	.....	.....	.....	.....	.....	.....
Ethyl cyclohexane.....	.9	.....	6.6	.....	.....	.....	.....	.....	.....	.....
<b>MIXTURES</b>										
Water gas.....	7.0	.....	72	.....	.....	.....	.....	.....	.....	.....
Carbureted water gas.....	5.5	.....	36	.....	.....	.....	.....	.....	.....	.....
Pittsburgh natural gas.....	4.8	.....	13.5	.....	.....	.....	.....	.....	12.0	14.4
Other natural gases.....	1.8-6.5	.....	13-17	.....	.....	.....	.....	.....	.....	.....
Benzine.....	1.1	.....	.....	.....	.....	.....	.....	.....	.....	.....
Gasoline.....	1.4	.....	7.6	.....	.....	.....	.....	.....	11.6	14.4
Naphtha.....	.....	0.8	.....	5	.....	.....	.....	.....	.....	.....
Kerosene.....	.....	.7	.....	5	.....	.....	.....	.....	.....	.....
Coal gas.....	5.3	.....	32	.....	7	.....	70	.....	11.5	14.4
Coke-oven gas.....	4.4	.....	34	.....	.....	.....	.....	.....	.....	.....
Blast furnace gas.....	35	.....	74	.....	.....	.....	.....	.....	.....	.....
Producer gas.....	17	20-35	70	70-80	.....	.....	.....	.....	.....	.....
Oil gas.....	4.7	.....	33	.....	.....	.....	.....	.....	.....	.....

slow-burning metal fuels, the burning time is an appreciable part of the total burst duration.

#### 5-4.1.1 Ignition and Combustion of Aircraft Fuels

It is generally accepted<sup>9,10</sup> that the combustion of a hydrocarbon: (1) occurs in the gas phase, (2) involves a chain-reaction mechanism which includes the formation of unstable species such as free atoms and free radicals, and (3) can occur only when the concentration of the hydrocarbon vapor in the air falls within certain well-defined limits, as illustrated in Table 5-6.<sup>11</sup> Normal variations in atmospheric pressure do not appreciably affect the limits of flammability; and, for most mixtures, there is a straight line relationship between the limit of flammability and the initial temperature of the mixture.<sup>12</sup>

For fuel concentrations within the flammability zones, a fire or explosion can result from contact with an incendiary source when the temperature of this source is sufficiently high. Various methods have been tried to determine the minimum ignition temperatures for various liquid fuels. A popular experimental procedure for such determinations involves confinement of the fuel vapor and air mixture in a suitable container and application of external heat until the mixture ignites. In general, the hydrocarbons of a higher molecular weight tend to ignite at lower temperatures. There exists, however, an ignition lag<sup>13</sup> (Paragraph 3-3.6.1) which is dependent upon several variables.

Grades JP-1 and JP-3 aviation fuel have minimum ignition temperatures between 400°F and 500°F, with an associated ignition lag from 100 to 200 seconds. Aviation gasolines have minimum ignition temperatures of 800°F to 950°F with an ignition lag of 2.0 to 2.5 seconds.<sup>14</sup> The ignition lag for all hydrocarbon fuels becomes less with increasing temperatures. At the minimum ignition temperature of gasoline, about 900°F, the ignition lag for kerosene is in the range of 2 to 10 seconds.<sup>15</sup> Fires, therefore, can be initiated and propagated in a flammable kerosene vapor and air mixture as readily as in a gasoline vapor and air mixture if both mixtures are within the flammability zone. Consequently, factors which control the formation of fuel vapor are of primary importance in determining ignition characteristics.

The energy required to vaporize a given quantity of kerosene is somewhat less than that for gasoline. The energy must be available, however, at somewhat higher temperatures because of the lower volatility of kerosene. The energy made available for evaporation of fuel by the flame of a self-propagating fire is roughly the same for gasoline and kerosene inasmuch as heat of combustion for both fuels lies in the range of 20,000 to 22,000 BTU per pound.

It is well established<sup>16</sup> that fires can be initiated by an incendiary bullet penetrating self-sealing aviation fuel cells above the liquid level, if the free space contains air, perhaps because of a previous puncture or air leaking into the tank. Rarely, if ever, has a fire been started inside the tank by an incendiary bullet striking below the liquid level. In fact, during developmental tests of incendiary ammunition, care was always taken to strike the tank below the liquid level with a second shot if the first shot failed to ignite. All effort was toward developing an incendiary bullet with one shot ignition capability below liquid level as this was most difficult to achieve. Success was achieved when incendiaries of long burst duration and long particle burning time were developed. These long burning particles ignite the small spurt of fuel which is forced through the bullet hole after 30 to 50 milliseconds by the pressure wave set up inside the tank by the bullet.

Flame will propagate in kerosene mist-air mixtures for a wider range of concentrations than in kerosene vapor-air mixtures. It is impossible to obtain a concentration of kerosene mist in air too rich to be ignited if the temperature is below the flash point of kerosene. However, at temperatures high enough to produce a vapor concentration in air near the upper limit of flammability, the mixture may be so rich that it fails to propagate. The initiation of a mist explosion takes place after the evaporation of mist droplets near the ignition source from a local vapor concentration within the explosive limits. This vapor ignites to form the initial flame front. Propagation of the flame proceeds by evaporation of droplets which form an inflammable gas mixture in the preheating zone in advance of the flame front.

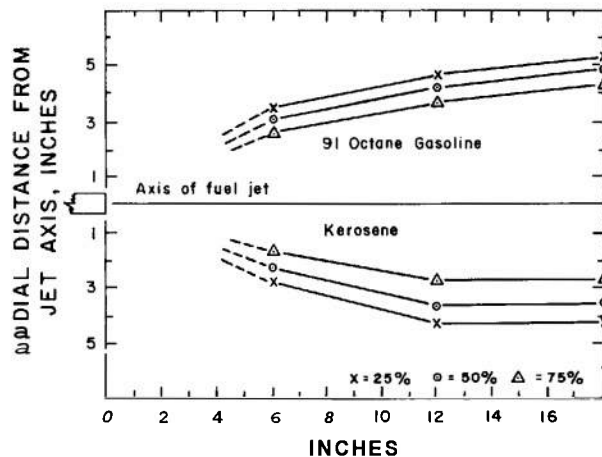

Figure 5-1. Constant Ignition Probability Regions About a Fuel Jet of Gasoline or Kerosene

Studies of phenomena associated with the penetration of liquid fuel tanks show that hydrodynamic forces resulting from the impact of a projectile on an aircraft fuel cell produce a pressure wave in the stored liquid. A high, positive pressure is near the point of tank penetration a few milliseconds after impact by the projectile. The fuel spray emerging from the hole made by the projectile has the normal characteristics of filament jets with droplets forming at the leading edge of the filament.

The basic factors which account for the differences in flammability characteristics of aircraft fuels are the relative volatility and viscosity of the fuels. The relatively low volatility and high viscosity of kerosene make it considerably more difficult to ignite than gasoline. Results of tests (with fuel jets designed to simulate the fuel spray made as a projectile penetrates a fuel tank) presented in Figure 5-1 indicate that the probability of a positive ignition is greater for gasoline than for kerosene at any point in the volume surrounding the axis of the jet. The type of fire occurring with the gasoline jet is usually different than that occurring with kerosene. Most gasoline fires propagate rapidly through the fuel spray. Little, if any, unburned fuel is left in the area. In contrast, nearly all kerosene ignitions are localized, seldom propagating more than a few inches from the point of ignition so that most of the fuel is left unburned.

The effectiveness of incendiary ammunition also

depends strongly on the ambient pressure and the supply of oxygen from the atmosphere since these factors are important if a self-sustaining fire is to result from the action of incendiary bullets. Information obtained from tests in partially inert atmospheres, both in altitude chambers and in actual flight tests, indicates that damaging fuel fires cannot be started at very high altitude. Studies with several pure fuels indicate that the relationship between spark minimum ignition energy  $H$  and pressure for a fuel-air mixture can be represented by:<sup>18</sup>

$$H = \frac{k}{p^n} \quad (5-7)$$

where  $p$  is the pressure,  $k$  is a constant which depends on the nature of the fuel, and  $n$  is another constant having a value of about 1.82. Even if fires are initiated at high altitude, the nature of the fires, especially at the higher airflows, might be diffused and low in temperature, thus limiting the damage produced.

#### 5-4.1.2 Nature of a Small Arms Incendiary Burst

As already indicated, the burst produced by the functioning of small arms incendiaries is fundamentally an ignition source for starting a destructive fuel fire in an aircraft. The amount of energy transferred to the fuel depends on the nature of the combustion process (the temperature reached and the characteristics of the products of combustion), the mode of energy transfer process, and the efficiency with which the energy is absorbed by the fuel.

The maximum temperature reached in an incendiary burst is a measure of both its relative intensity and duration, as a result of chemical reactions which occur within the burst to the end of its cooling cycle. A consideration of the burst temperature, and the effects of the physical and thermodynamic properties of incendiary mixture ingredients and their reaction products, comprise an important area of study concerning an incendiary burst. The temperature produced by an incendiary burst can be estimated by calculations using the methods outlined in Paragraph 3-2.5. It is necessary to assume, arbitrarily, the amount of atmospheric oxygen available for combustion of the

incendiary mixture. The extreme conditions are either: (1) that the only oxygen available for combustion is that contained in the mixture components due to insufficient time for the diffusion of atmospheric oxygen into the flame; or (2) that the surrounding air supplies the additional oxygen required for complete combustion of the reactants. The actual condition is probably somewhere between. Limited experimental data obtained for bursts in controlled atmospheres indicate that the surrounding atmosphere does not enter appreciably into the incendiary reaction so that condition (1) is the better assumption. The difference in the results is small, however, because of the necessity for heating the nitrogen of the air under assumption (2). (See also Example 4, Paragraph 3-2.5.)

The rate of heat transfer from the burst cloud to its surroundings depends also upon the method by which the heat is transferred. Heat can be transferred by combustion, convection, and radiation; however, at temperatures above the ignition temperature of aircraft fuels, heat transfer by radiation is probably the dominant method. Radiant energy emitted by the liquid, solid, and gaseous species in an incendiary burst is a complicated function of wavelength, pressure, geometry, and chemical composition of the emitting molecular aggregate, as well as of temperature. However, based on experimental results, it can be assumed that the incendiary burst cloud radiates as a graybody with a relatively high emissivity.

The rate of heat transfer from an incendiary burst cloud, radiating as a graybody may be expressed by:

$$dQ/d\theta = \frac{E_B E_S \sigma (T_B^4 - T_S^4) A}{E_B + E_S - E_B E_S} \quad (5-8)$$

where  $A$  is the total radiating area of the components in the burst cloud,  $dQ$  is quantity of heat radiated by the incendiary burst cloud during time interval  $d\theta$ ,  $\sigma$  is the Stefan-Boltzmann constant,  $E$  is the emissivity, and  $T$  is the absolute temperature. The subscript  $B$  refers to the burst and the subscript  $S$  refers to the surroundings. By combining this equation with the equation  $dQ = mCdT$  where  $C$  is the overall average specific heat—i.e., equals the heat evolved per gram, including that from phase changes, in the cooling of the reaction

products from the maximum temperature reached by the incendiary burst to the minimum effective temperature divided by the temperature difference—and neglecting  $T_S^4$  since it is very much smaller than  $T_B^4$ , integration yields:

$$\theta^2 = \left( \frac{1}{T_2^3} - \frac{1}{T_1^3} \right) \frac{m}{3} \frac{(E_B + E_S - E_B E_S) C}{\sigma E_B E_S A} \quad (5-9)$$

If it is assumed that the radiating area  $A$  and emissivities  $E_B$  and  $E_S$  have average values which may be assumed constants for the various bursts, the terms outside of the parentheses may be considered a constant  $K$  and:

$$\theta_2 = kC \left( \frac{1}{T_2^3} - \frac{1}{T_1^3} \right) \quad (5-10)$$

If  $k$  is assumed to be  $10^8$  ( $A \cong 2 \times 10^4 \text{cm}^2$ ,  $E_B = 0.9$ ,  $E_S = 0.1$  and  $m = 1$ ), the curves in Figure 5-2 result where it is assumed that the minimum effective temperature is  $800^\circ\text{K}$ .

If the adiabatic flame temperature can be calculated or experimentally obtained and if the heat of reaction is known, Figure 5-3 can be used to estimate an average specific heat. If Figures 5-2 and 5-3 are combined, Figure 5-4 results. As can be seen, the cooling time varies directly with the average specific heat. The curves also indicate that any increase in the burst temperature above  $2000^\circ\text{K}$  results in only a small increase in the cooling time. Change in cooling times resulting from transformations is difficult to determine because the details of the cooling mechanism are not known.

Experimental cooling curves for incendiary mixtures are given in Figure 5-5.<sup>19</sup> IM-11, 50 percent barium nitrate and 50 percent magnesium-aluminum alloy, is one of the standard mixtures used in incendiary bullets. IM-23, 50 percent potassium perchlorate and 50 percent magnesium alloy, contains no barium nitrate and its calculated temperature is higher than that for IM-11. IM-63—50 percent calcium peroxide, 45 percent red phosphorus, and 5 percent aluminum hydroxide—does not contain either barium nitrate or alloy, and has a considerably lower theoretical maximum temperature than IM-11. It is to be noted that IM-103, 50 percent red phosphorus and 50 percent magnesium-aluminum alloy, does not contain an oxidizer.

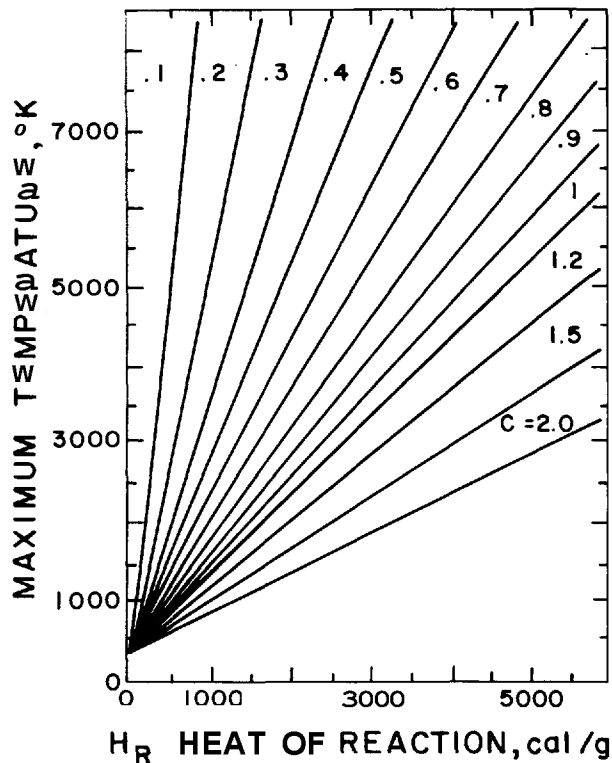

Figure 5-2. Maximum Temperature,  $T$ , as a Function of Heat of Reaction and Average Specific Heat,  $C$

#### 5-4.1.3 Small Arms Incendiary Fillers

Small arms incendiary ammunition, which now includes ammunition through 40 mm, has been developed, like other ammunition, to meet the particular needs of the using Services. Important modifications and improvements were made through the years in response to changes in Service needs or anticipated changes in Service requirements. Early developments in small arms incendiary ammunition fillers have been discussed in the historical review of incendiaries (Paragraph 5-1).

Sensitive explosives—including mercury fulminate, lead azide, and PETN—were employed in some early incendiary fillers. Other explosives—including tetryl, MOX, TNT, Haleite, and EDNA—also have been tried in smaller nonfuzed incendiary ammunition but have not proved satisfactory. High explosive incendiary ammunition in 20 mm and larger sizes contains a purely ex-

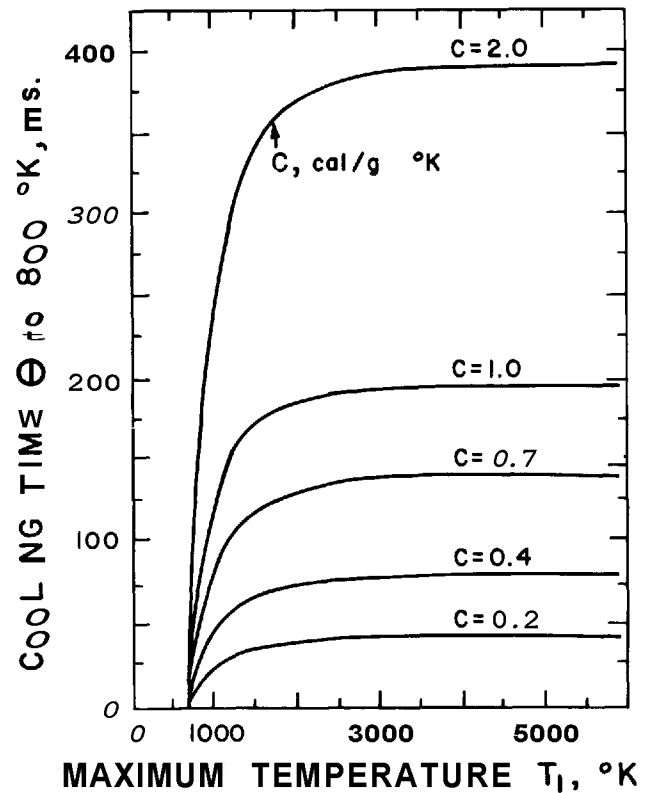

Figure 5-3. Cooling Time to 800°K as a Function of Temperature and Heat Capacity,  $C$

plosive material in addition to its incendiary filler material.

Magnesium-aluminum alloys have been an essential ingredient in most of the successful incendiary mixtures, and have replaced both white phosphorus incendiaries and tracer compositions. Tracers, first used as incendiaries, employed a filler consisting of two parts magnesium and seventeen parts barium peroxide for incendiary purposes. Until the development of the highly satisfactory incendiary filler based on a magnesium-aluminum alloy (50/50) fuel, with barium nitrate as the oxidizer, changes in tracer mixtures used as incendiaries were limited to those which would improve the performance of metal-oxidant compositions. Numerous incendiary mixtures have been tested for use in small arms ammunition in the period since the beginning of World War II. A detailed card file listing of the incendiary mixtures which have been given an IM number (approximately 1000) is maintained at Frankford Arsenal.



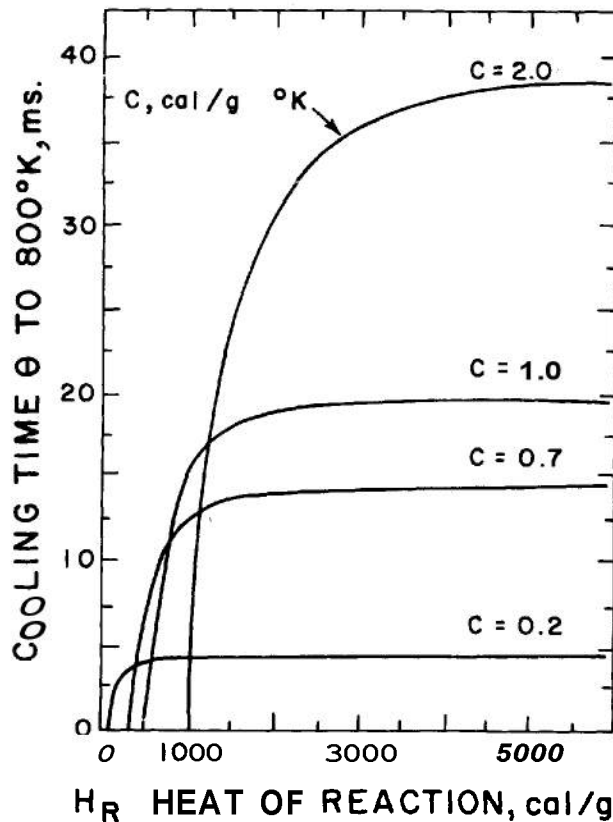

figure 5-4. Cooling Time to 800°K as a Function of Heat of Reaction and Specific Heat, C

#### 5-4.1.3.1 Fuels

Incendiary compositions containing magnesium-aluminum alloy have been the basis of most of the standard incendiary compositions investigated until recent years. Studies have indicated that an alloy of 50/50 proportions, prepared by grinding with a particle size range from 60 to 325 mesh, is optimum for a wide variety of applications. The effects of variation in the granulation of the magnesium-aluminum alloy were evaluated early in the program, leading to the development of IM-11 (composed of 50 percent magnesium-aluminum alloy 50/50, and 50 percent barium nitrate) which was the basic incendiary mixture used in World War II. Figure 5-6 shows the cooling curves and burst duration (the time from ignition until burst cloud cooled to 1540°K) curves for mixtures which contain either the ground or atomized alloy in a variety of mesh sizes with some barium nitrate. The results presented in this

figure indicate that an increase in burst duration and cooling time results with coarser and with atomized or spherical particles. Firing tests confirm these results. Evaluations of magnesium-aluminum alloys other than 50/50 show that the 50/50 alloy is superior for a variety of applications whether ground or atomized.

In an attempt to develop improved small arms incendiary mixtures, a large number of metals and alloys were evaluated for their effectiveness as incendiary fuels with several oxidizing agents, as reported in detail in Reference 6. Some of these mixtures produced incendiary bursts which have a longer duration than those produced by IM-11. These mixtures also have proved to be more effective than IM-11 in comparative tests against aircraft targets.

#### 5-4.1.3.2 Oxidizers

A wide variety of materials have been used as oxidizers in incendiary mixtures. An oxidizer, for use in mass-produced items which are loaded by automatic machines, must meet a variety of requirements in addition to being able to supply the necessary quantity of oxygen.

The effects of oxidizer particle size on incendiary bursts have been studied. Incendiary mixtures containing oxidizer particles of comparatively large size (100 to 200 mesh) could not be ignited unless the mixture contained finely divided (less than 325 mesh) alloy fuel particles. Mixtures containing fine or medium-sized barium nitrate particles would not burn except when mixed with coarse alloy. Alloy particle sizes in the range specified for IM-11 reacted erratically with either a narrow range coarse or a fine barium nitrate powder. Specification grade alloy reacted best with barium nitrate which consisted of both fine and coarse particle sizes. The cooling durations of the incendiary burst for the few mixtures which could be ignited increased as the particle size of the barium nitrate was increased, but these changes were relatively small.

Some of the alkali metal and alkaline earth nitrates have been more widely employed than other types of oxidizers because they are available at low cost, contain large quantities of available oxygen, are safe, and can be handled easily.

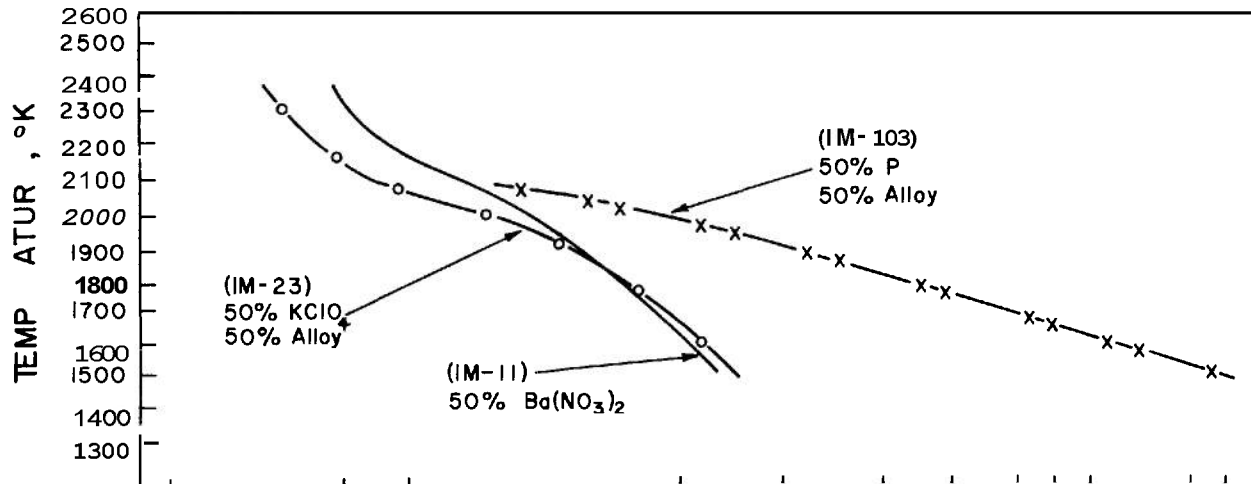

Figure 5-5. Time-Temperature Histories for IM-11, IM-23 and IM-703

Barium nitrate has been incorporated in over 200 incendiary mixtures, including the widely used IM-11 filler, and has been utilized in proportions ranging from one percent to 65 percent of the total mix. This oxidizer is stable to approximately 600°C, has a high critical humidity, is easily handled, and is available at moderate cost. Some compositions in which barium nitrate is used as the primary oxidizer are improved, from the standpoint of incendiary functioning, by the addition of a small quantity of a more reactive oxidizer such as ammonium nitrate or potassium perchlorate. Ammonium nitrate has been used in several incendiary mixtures as an oxidizer, however, it has a relatively low decomposition temperature and tends to sensitize incendiary mixtures in which it is used. Other nitrates are potentially good oxidizers, but are not widely used because of some undesirable characteristic, such as being relatively hygroscopic or uneconomical.

The alkali metal perchlorates are the second most widely used group of oxidizers for incendiary mixtures.<sup>2</sup> Potassium perchlorate has been used in many incendiary fillers in proportions varying from 2.5 percent to 75 percent of the total mixture. Potassium perchlorate has essentially the same total and available oxygen content as barium ni-

trate but exhibits a lower decomposition temperature. Mixtures containing potassium perchlorate tend to be more sensitive and to burn faster than mixtures which contain only barium nitrate as the oxidizer. Ammonium perchlorate has also been used as an oxidizer. This material is considered to be an explosive since the hydrogen contained in the compound can be oxidized rapidly as the decomposition of ammonium perchlorate takes place. This oxidizer-explosive has been used extensively in the MOX series of metalized explosives and probably contributes to the explosive energy of these compositions, as well as providing oxygen for the burning of the metallic fuel which provides the major incendiary effect of MOX-loaded ammunition. Ammonium perchlorate is a rather sensitive oxidizer and, therefore, is somewhat hazardous to handle. Other perchlorates have been used; but, in general, they are hygroscopic and, therefore, are difficult to handle in production loading equipment.

Some peroxides and less stable oxides can be used as oxidizers in incendiary mixtures. Lead dioxide is probably the most important member of this group, and it has been used in several incendiary fillers. It tends to sensitize mixtures in which it is used, although by itself it is safe

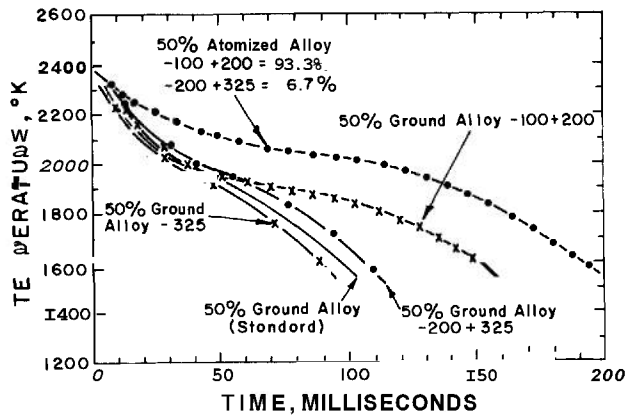

Figure 5-6. Cooling Curves for Mixtures Containing Various Particle Sizes and Shapes of Magnesium Aluminum 50/50 Alloy

and easy to handle. Less oxygen is available from lead dioxide than from many of the nitrate and perchlorate oxidizers. Its high density has made lead dioxide useful for applications where an increase in bullet weight is desirable.

A few additional oxidizers that have been evaluated in incendiary mixtures are worthy of mention. These include potassium chlorate, which is a relatively good oxidizer except for its sensitivity and incompatibility with certain fuels, notably red phosphorus; strontium chromate, potassium dichromate, and potassium permanganate have also been used. None of these has been found to be fully satisfactory as oxidizers for incendiary mix applications.

One of the most intriguing applications of oxidizing materials to the destruction or damaging of aircraft structures is the direct reaction of an oxidizing agent with the fuel contained in the aircraft. The idea is appealing because of the potential chemical energy release since only oxygen or an oxidizing agent is placed in the projectile and no space is required for fuel. Many rather difficult practical problems are involved in adapting this principle to realistic target conditions using standard projectile components and fuzing mechanisms. Some of the oxidizing chemicals which might be useful in this connection include  $IF_5$ ,  $ClF_3$ ,  $BrF_3$ ,  $HClO_4$ ,  $OF_2$ ,  $O_2F_2$ ,  $O_3F_2$ ,  $NO_3F$ ,  $ClO_2F$ , and  $NF_3$ .

### 5-4.1.3.3 Binders, Lubricants, and Other Incendiary Mixture Additives

The first metal-fuel incendiary compositions used in small arms ammunition contained only the metal-fuel and a suitable oxidizer. The mass production of small arms incendiary ammunition during World War II created problems concerning pelleting of incendiary mixtures, sticking of compression punches, lumping of mixtures during handling, and failure of mixtures to flow properly in the automatic loading equipment. These problems were met by adding binders, lubricants and flow promoters to the then standard compositions. The amount of additive present in the compositions was small and did not impair the incendiary functioning of the ammunition, and they were essential to the successful mass production of incendiary ammunition. Without these additives it would have been impossible to achieve the high level of ammunition quality that was maintained during World War II. Since then, the requirements for mass produced ammunition have become even more stringent.

The two most frequently used binders in small arms incendiary mixtures are calcium resinate and asphaltum. In incendiary filler compositions, calcium resinate is used in amounts varying between one and two percent, and asphaltum is used in amounts varying between one and five percent. A number of other binders have been tested in several compositions from time to time. These include Acrawax, dextrin, starch, nitrocellulose, gum arabic, polyvinyl alcohol, red gum, vistanex (a rubber preparation), and AP-2 (a jellied gasoline and aluminum mixture),

Graphite, in a range of particle sizes, has been used successfully as a lubricant to prevent the sticking of pelleting and compression punches during the loading of incendiary ammunition. This lubricant is normally added in amounts ranging from 0.25 percent to 2.0 percent. Stearates of zinc and aluminum have been employed in a number of small arms incendiary compositions to prevent lumps from forming in the mixtures and to improve the flow characteristics during the automatic loading processes. These ingredients are of some assistance in forming pellets of the mix in addition to their flow-inducing characteristics. Zinc stearate

**TABLE 5-7**  
**TYPICAL SMALL ARMS INCENDIARY MIXTURES**

IM-11	49% Potassium Perchlorate
50% Magnesium-Aluminum Alloy (50/50)	2% Calcium Resinate
50% Barium Nitrate	
IM-21A	IM-139
48% Magnesium-Aluminum Alloy (50/50)	10% Magnesium-Aluminum Alloy (50/50)
48% Barium Nitrate	40% Red Phosphorus
3% Calcium Resinate	47% Barium Nitrate
1% Asphaltum	3% Aluminum Stearate
IM-23	IM-142
50% Magnesium-Aluminum Alloy (50/50)	46% Magnesium-Aluminum Alloy (50/50)
50% Potassium Perchlorate	48% Barium Nitrate
	5% Asphaltum
IM-28	1% Graphite
50% Magnesium-Aluminum Alloy (50/50)	IM-214
40% Barium Nitrate	50% Zirconium (60/80) (lot 6)
10% Potassium Perchlorate	25% Magnesium-Aluminum Alloy
	25% Potassium Perchlorate ( <b>-250</b> )
IM-68	IM-241
50% Magnesium-Aluminum Alloy (50/50)	50% Zirconium (20/65)
25% Ammonium Nitrate	25% Magnesium-Aluminum Alloy
24% Barium Nitrate	25% Potassium Perchlorate ( <b>-250</b> )
1% Zinc Stearate	
IM-69	IM-385
50% Magnesium-Aluminum Alloy (50/50)	49% Magnesium-Aluminum Alloy (50/50)
40% Barium Nitrate	49% Ammonium Perchlorate
10% Iron Oxide (Fe <sub>2</sub> O <sub>3</sub> )	2% Calcium Resinate
IM-112	MOX-2B (High Explosive Incendiary Fillers)
45% Magnesium-Aluminum Alloy (50/50)	52% Aluminum Powder
5% Tungsten Powder	35% Ammonium Perchlorate
50% Barium Nitrate	6% RDX/Wax (97/3)
	4% TNT (Coated on the Ammonium Perchlorate)
IM-136	2% Calcium Stearate
49% Magnesium-Aluminum Alloy (50/50)	1% Graphite

in the amounts of 1%-2% has been most widely used for this purpose. Aluminum stearate has also been employed for this purpose.

#### 5-4.1.3.4 Typical Compositions

The compositions of 14 small arms incendiary mixtures, considered to be typical, are given in Table 5-7.

#### 5-4.1.4 Typical Small Arms Incendiary Bullets

Typical incendiary rounds are shown in Figures 5-7 through 5-10. Illustrated are a caliber .50 incendiary bullet, Figure 5-7, and a caliber .50 armor-piercing incendiary, Figure 5-8. A 20 mm armor-piercing incendiary bullet is shown in Figure 5-9 and a 20 mm high explosive incendiary projectile is shown in Figure 5-10.

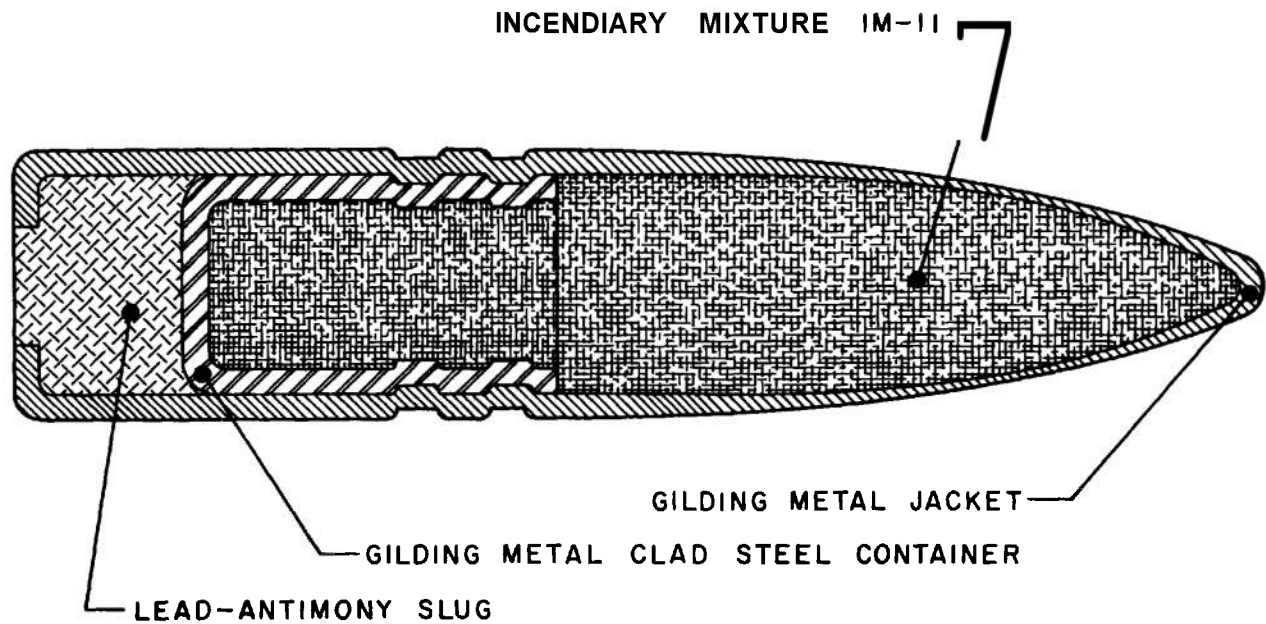

**TOTAL WEIGHT: 512 GRAINS**

*Figure 5-7. Typical Caliber .50 Incendiary Bullet*

#### 5-4.2 INCENDIARIES FOR GROUND APPLICATION

Ground incendiaries include that class of munitions used for damage, mainly by combustion, to ground targets and are considerably larger than the small arms incendiaries previously discussed. Incendiary bombs, for example, are more effective against cities than high explosives, especially when antipersonnel features are included to delay fire fighting operations. The delay in fire fighting operations allows the smaller fires to grow and unite to form a conflagration which is almost impossible to control. In many cases, toxic effects resulting from the use of incendiaries or flame weapons (high carbon monoxide content-low oxygen content) cause many casualties. In some cases, the psychological fear prevents effective fire fighting operations and may result in the loss of equipment through abandonment.

Because progress in the development of incendiary and flame weapons for use against ground targets has been made mainly during times of stress, emphasis has been directed toward the development of weapons which could be rapidly put into the

hands of combat troops. Little, if any, effort was directed toward studying those factors concerned with the initiation of destructive fires in various targets. As a consequence, less is known about the factors which might increase the effectiveness of incendiary munitions against ground targets than is known about the effectiveness of incendiaries against aircraft targets.

##### 5-4.2.1 Ignition and Combustion of Ground Targets

Incendiary and other flame-producing weapons, like most weapons used against ground targets, are a source of energy which, when absorbed by the target, will cause damage. The amount of energy absorbed from the incendiary source by the target is not usually sufficient to produce appreciable damage but serves only to initiate combustion of the target in the oxygen of the air. Small fires started in this manner serve as ignition sources for the remainder of the target material, resulting in the spread of the fire. The ignition process and early growth of the fire are the critical stages in the development of a damage-producing fire.

To initiate burning of a target in air, three

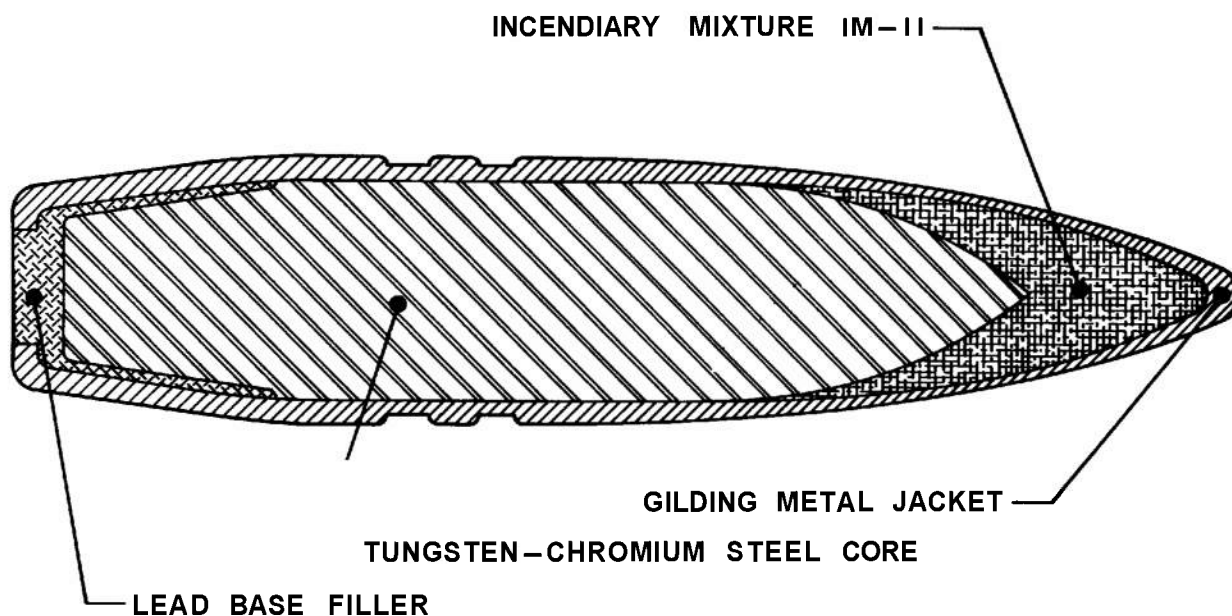

**TOTAL WEIGHT: 662 GRAINS**

*Figure 5-8. Typical Caliber .50 Armor-Piercing Incendiary Bullet*

essentials must be provided, namely : (1) a source of heat to initiate the fire, (2) combustible material which serves as kindling, and (3) the fuel. All incendiary munitions, except those which are spontaneously combustible, must contain an initiator. The major part of an incendiary filling serves as the kindling and the target supplies the fuel. The efficiency of an incendiary depends on the total heat output and the rate of transfer of the energy to the target so as to initiate a sequence of events which will result in the burning of the target. Solid materials, such as wood, must be heated to a sufficiently high temperature in order to form the gaseous intermediates to react with the oxygen of the air. Liquid fuels, as discussed in detail in Paragraph 5-4.2.2.2.1, also must be vaporized before combustion is initiated.

#### 5-4.2.2 Incendiary Compositions

Most of the research on incendiaries has been concerned with quantity and type of combustible used as an incendiary filler. Incendiary fillers can be basically classified into three categories: metal-based incendiaries, liquid fuel-based incendiaries,

and a combination of these two. Fillings can also be classified into those which owe their incendiary effect to a self-supporting exothermic reaction and those which depend on atmospheric oxygen for their combustion.

##### 5-4.2.2.1 Metal-Based Ground Incendiaries

Incendiaries containing metallic components are of two types: those which utilize the oxygen of the air in their combustion, and those in which an oxidizing agent furnishes the oxygen.

Magnesium-aluminum alloy used both as the case and in the composition of a four-pound incendiary bomb is an effective incendiary and was widely used in World War II in raids against German and Japanese cities. Reaction with oxygen of the air produces more heat with an incendiary metal than with solid oxidizing compounds. The use of these compounds, therefore, must be justified by an increase in effectiveness due to the higher rate of heat release.

Thermite-type incendiary mixtures are composed of approximate oxygen-balanced mixtures of reducing and oxidizing agents. While there are

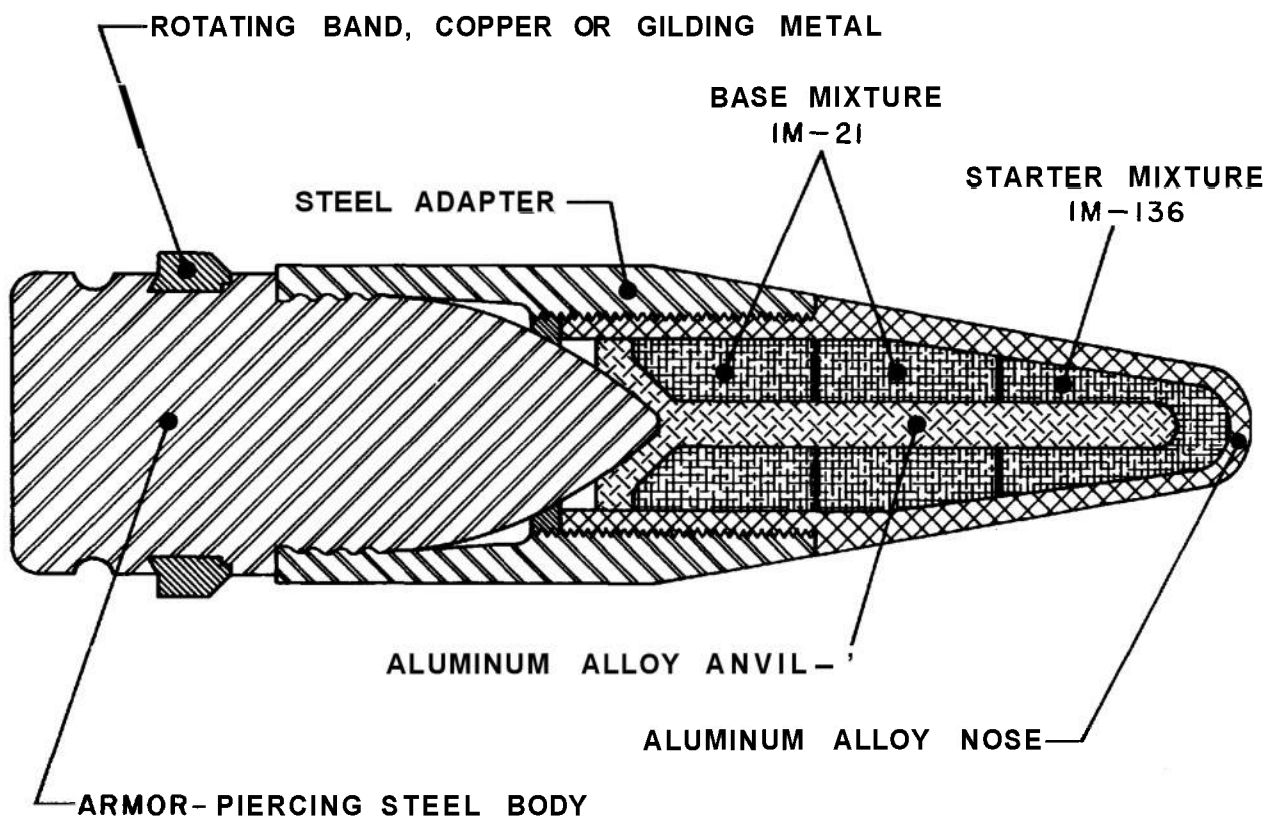

**TOTAL WEIGHT: 1700 GRAINS**

*Figure 5-9. Typical 20 mm Armor-Piercing Incendiary Bullet*

a large number of possible combinations which contain one or more reducing agents with one or more oxidizing agents; aluminum (Table 5-1) and, to a lesser extent, magnesium (Table 5-8) have been the only reducing agents used in thermite-type incendiary mixtures.

Military thermite for incendiary purposes is composed of 2.75 parts of iron oxide scale and one part of granular aluminum.<sup>20</sup> The reaction:



gives the stoichiometrical ratio of one part of aluminum to 3.2 parts of iron oxide,  $\text{Fe}_3\text{O}_4$ . Ferric oxide,  $\text{Fe}_2\text{O}_3$ , reacts as follows:

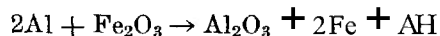

and gives the stoichiometrical ratio of one part of aluminum to 2.96 parts of ferric oxide. Ferrous oxide,  $\text{FeO}$ , reacts as follows:

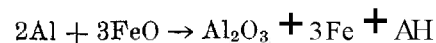

and gives the stoichiometrical ratio of one part of aluminum to four parts of ferrous oxide. Since iron oxide scale (hammer scale) is a mixture of ferrous and ferric oxide in various proportions, the stoichiometric amount of aluminum required to react with the available oxygen present will also vary.

The ferrous oxide,  $\text{FeO}$ , content of the hammer scale has little effect on either the burning time or the penetration of the molten iron produced by the thermite reaction. A lower ferrous oxide content produces a considerably better flame and better propagation of burning; however, for values below 22 percent ferrous oxide, the improvement is slight. Thinner flake scales, such as pipe scale and rod scale, have been found to be more satisfactory than coarser scales; however, the use of a slight excess

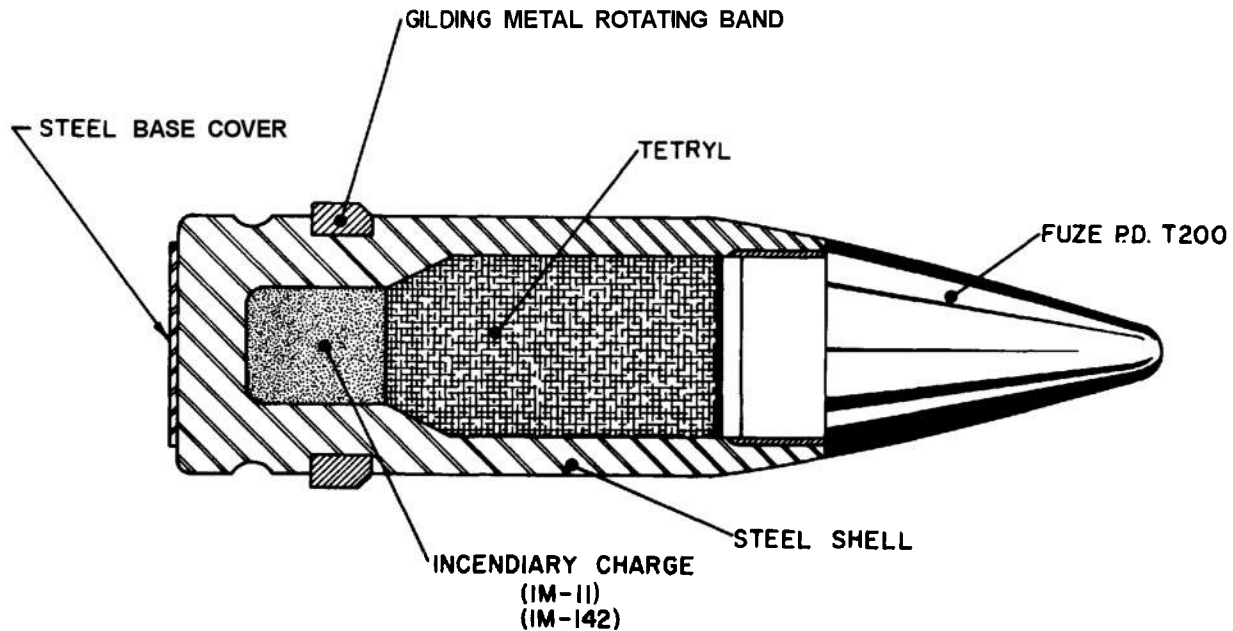

TOTAL WEIGHT: 1600 GRAINS (APPROX.)

Figure 5-70. Typical 20mm High Explosive Incendiary Projectile

of aluminum minimizes the effect of particle shape of the hammer scale.

The use of low-purity aluminum (92.5 percent) requires a higher ratio of aluminum to hammer scale (1 to 2.7-2.8) to obtain optimum burning characteristics. The use of fine-mesh granular aluminum results in decreased burning times approaching a minimum limit with decrease in particle size. If the aluminum is too coarse, poor propagation, poor flame, and a longer burning time result.

During World War I, binders such as sodium silicate, sulfur or celluloid were added in order to reduce segregation of the thermite after loading; however, these techniques were only partially successful. Thermite has not been used since World War I for incendiary applications. While the heat released by a thermite mixture is sufficient to heat the products of reaction to around 3000°C, the incendiary action is confined to a relatively small area. In order to improve the incendiary effectiveness, several other incendiary compositions, including several modified thermite compositions,

have been tried without appreciable success. The compositions of some of the incendiary mixtures tried are given in Table 5-9.

#### 5-4.2.2.2 Liquid Fuel-Based Incendiaries

Liquid fuel incendiaries depend entirely upon the oxygen of the air for their combustion. The organic substance with the highest heat of combustion on a volume basis is anthracene with 11,900 calories per milliliter. A wide variety of natural oils and waxes fall in the range of 8,500 to 9,200 calories per milliliter. For hydrocarbons, there is a definite relationship between the heats of combustion and the hydrogen-carbon ratio as shown in Table 5-10. The order of heat on a unit-volume basis is the inverse of the order of the hydrogen-carbon ratios, while the position is reversed on a unit-weight basis. While the heat evolution per unit-volume of n-octane is comparatively low, its heat evolution per unit-weight is very high (11,500 calories per gram), being exceeded only by boron and beryllium on this basis.



**TABLE 5-8**  
**HEAT OF REACTION OF THERMITE-TYPE**  
**MIXTURES CONTAINING MAGNESIUM**

<i>Mixture</i>	<i>Heat of reaction, cal/g</i>
Mg + Sb <sub>2</sub> S <sub>3</sub> .....	507
5Mg + Ba(NO <sub>3</sub> ) <sub>2</sub> .....	1,636
4Mg + BaSO <sub>4</sub> .....	1,046
4Mg + CaSO <sub>4</sub> .....	1,529
3Mg + Fe <sub>2</sub> O <sub>3</sub> .....	1,030
4Mg + Fe <sub>3</sub> O <sub>4</sub> .....	956
2Mg + FeS <sub>2</sub> .....	764
Mg + PbO .....	378
2Mg + PbO <sub>2</sub> .....	789
4Mg + Pb <sub>3</sub> O <sub>4</sub> .....	736
5Mg + PbSO <sub>4</sub> .....	1,054
4Mg + MgSO <sub>4</sub> .....	1,661
2Mg + MnO <sub>2</sub> .....	1,248
5Mg + 2KNO <sub>3</sub> .....	793
4Mg + KClO <sub>4</sub> .....	2,442
9Mg + K <sub>2</sub> S <sub>2</sub> O <sub>8</sub> .....	1,870
4Mg + K <sub>2</sub> SO <sub>4</sub> .....	1,916
4Mg + Na <sub>2</sub> SO <sub>4</sub> .....	1,060

#### 5-4.2.2.2.1 Liquid Incendiaries

Liquid incendiaries such as petroleum oils, carbon disulfide, wood-distillation products, and other flammable liquids, were tested during World War I. These materials all had the drawback of excessive dispersion; to overcome this, the liquids were absorbed in some material such as cotton

waste, but this method was only fairly satisfactory. During World War II this idea was revived and, based on development work, 14 percent cotton waste saturated with 86 percent of a 50/50 mixture of gasoline and fuel oil was tried as a possible filling for incendiary bombs, but was discontinued as more effective fillers became available.

#### 5-4.2.2.2.2 Solidified Liquid Incendiaries

Because of the high degree of dispersion and consequent flash burning of liquid incendiaries, many substances have been proposed for solidifying liquid incendiaries. These include ?

##### a. Fatty acid derivatives

- (1) Aluminum, sodium, zinc, and ammonium salts
- (2) Lead salts of hydroxy acids
- (3) Sulfonated products
- (4) Amides
- (5) Fatty acids *per se*
- (6) Natural waxes
  - (a) Nitrated
  - (b) Sulfonated
  - (c) *Per se*
- (7) Anilides

##### b. Polyhydroxy derivatives

- (1) Glycol compounds : Esters of fatty acids
- (2) Ethanolamine compounds
  - (a) Esters of fatty acids
  - (b) Compounds of mono-, di-, and tri-ethanolamine
- (3) Glycerol compounds

**TABLE 5-9**  
**'MODIFIED THERMITE COMPOSITIONS**

<i>Constituents</i>	<i>Composition, Percent</i>				
	<i>Therm-8</i>	<i>Therm 8-2</i>	<i>Therm 64-c</i>	<i>Barytes Thermite</i>	<i>Calcium Sulfate Thermite</i>
Iron Oxide Scale	61	55.2	44	59.2	—
Aluminum	22.8	25	25	25.3	40.9
Barium Nitrate	15	19.5	29	—	—
Sulfur	0.90	—	2	—	1.0
Castor Oil	0.30	0.30	—	—	0.3
Barium Sulfate	—	—	—	15.3	—
Calcium Sulfate	—	—	—	—	57.8

**TABLE 5-10**  
**HEATS OF COMBUSTION AND HYDROGEN-CARBON**  
**RATIOS OF SELECTED FUELS**

<i>Hydrocarbon</i>	<i>Hydrogen- Carbon Ratio</i>	<i>Calories per ml</i>	<i>Calories per g</i>	<i>Density, g/u</i>
Anthracene	0.72	11,900	9,500	1.25
Naphthalene	0.80	11,000	9,600	1.15
Toluene	<b>1.14</b>	8,800	10,200	0.866
Methylcyclohexane	2.00	8,600	11,100	0.769
n-Octane	2.25	8,100	11,500	0.706

- (a) Saponified vegetable oil mixes
- (b) Nitrated vegetable oils
- (c) Vegetable oils *per se*
- (4) Polysaccharide compounds
  - (a) Lactose anhydride
  - (b) Dextrins
  - (c) Pectins
- (5) Cellulose esters
  - (a) Ethyl cellulose (7 to 10 percent)
  - (b) Pulp
- e. Resinous derivatives
  - (1) Natural
    - (a) Alkali-treated resin
    - (b) Shellac
    - (c) Damar
    - (d) East India fossil
    - (e) African fossil
    - (f) New Zealand fossil
  - (2) Synthetic : Saponified polyacrylates
- d. Hydrocarbon derivatives
  - (1) Paraffin
  - (2) Synthetic rubber
  - (3) Natural rubber
  - (4) Salts of sulfonated petroleum fractions
  - (5) Salts of naphthenic acid
- e. Inorganic derivatives
  - (1) Organo-silicon compounds : Esters
  - (2) Bentonite
  - (3) Oil shale

Of these, only a few were ever found practical for use in thickening incendiary liquids. The most successful substances were:

- a. Rubber (natural and synthetic)
- b. Aluminum salts of mixed fatty acids and naphthenic acid
- c. Polyacrylates

#### 5-4.2.2.2.1 Rubber Thickeners

The addition of thickeners—e.g., smoked rubber, crepe rubber, and latex—to gasoline produces an incendiary filling resembling sticky rubber cement. Fillings of this type are reasonably satisfactory; the material sticks to the target and burns slowly enough to allow an effective transfer of heat to the target. During World War II, however, rubber was in critically short supply and other thickeners had to be developed. Satisfactory thickeners can also be made with some synthetic rubbers.

#### 5-4.2.2.2.2 Napalm Thickeners

The napalm thickener finally adopted consisted of a granular base aluminum soap of naphthenic, oleic, and coconut fatty acids. The sodium soap used for the precipitation of the aluminum soap contained 0.10 to 0.15 percent alpha-naphthol. The recommended formula of the organic acids used in making the napalm thickener was:

	<i>Parts by weight</i>
Coconut fatty acids	50
Naphthenic acid	25
Oleic acid	25

The aluminum content of the finished thickener

TABLE 5-11  
COMPOSITION OF IM-TYPE INCENDIARY GELS

code	IM	IM	IM	F-1416	F-1429	P-1431	F-1457
	Type 1	Type 2	Type 3				
Constituent	Composition, Percent						
Isobutyl methacrylate polymer <b>AE</b> (IM)	5.0	5.0	2.0	3.0	3.0	3.0	3.0
Stearic acid (Fatty acids)	3.0	—	—	1.0	4.0	3.0	4.5
Naphthenic acid	—	2.5	3.0	—	—	—	—
Calcium oxide	—	2.5	3.0	3.0	—	1.0	0.5
Caustic soda (40% solution)	2.0	—	—	3.1	4.0	3.5	—
Ammonium hydroxide (27% solution)	—	3.0	4.5	—	—	—	—
Gasoline	—	—	—	—	—	—	2.3
Water	88.75	87.0	87.5	87.6	86.5	87.3	89.3
	1.25	—	—	2.3	2.5	2.2	—

ranges from 5.4 to 5.8 percent and the moisture content from 0.4 to 0.8 percent. Varying the composition of napalm from the standard to 2:1:1 ratio of coconut to oleic to naphthenic acid indicated that the viscosity of the gel increased primarily with increased oleic acids and, to a lesser extent, with increased coconut acid above normal composition. The acid number of the coconut acid was found important. Iron was an undesirable impurity when found in the alum but not in the acid. Impurities in

napalm thickener which may cause partial or complete breakdown of gels formed with gasoline or oxidation of the thickener, include excess water, lime, caustic soda; soaps of sodium, copper, lead, iron, manganese, and cobalt; powdered or sheet zinc and lead; lead nitrate; rust preventatives containing amines, alcohols, and all acids. Tetraethyl lead, on the other hand, has no injurious effects.

The fundamental reactions may be expressed as follows (HR denotes the mixture of fatty and naphthenic acid) :

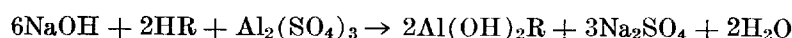
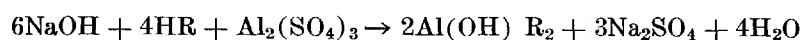

The soaps may hydrolyze:

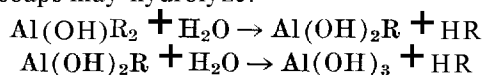

Because of hydrolysis,  $\text{AlR}_3$  does not form, and fatty acid in excess of that required remains as such :

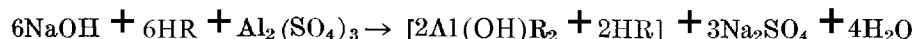

Three processes have been used successfully for the manufacture of napalm. All are based on the above equations, but the mechanical details for combining the materials differ.

Napalm, while a satisfactory thickener, is susceptible to oxidation by the atmosphere and is hygroscopic, resulting in a thickened gasoline with poor characteristics.

#### 5-4.2.2.2.3 Methacrylate Thickeners

Satisfactory thickened gasoline could be made when 15-20 percent isobutyl methacrylate polymer (IM) was added. Some satisfactory IM gels are summarized in Table 5-11.

Low temperature stability is favored by a low polymer content, the use of polymer of low meth-

**TABLE 5-12**  
**COMPOSITION OF PT INCENDIARY MIXTURES**

<i>Code</i>	<i>PT-1</i>	<i>PT-2</i>	<i>PT-3</i>
<i>Constituent</i>	<i>Composition, Percent</i>		
<b>Goop</b>	<b>49.0</b>	<b>30.0</b>	—
Isobutyl methacrylate polymer <b>AE</b>	<b>3.0</b>	—	—
Magnesium (coarse) (50/50 Mg-Al alloy)	10.0	10.0	<b>30.0</b> <b>10.0</b>
Sodium Nitrate	5.0	8.0	<b>6.5</b>
Gasoline	<b>30.0</b>	<b>44.0</b>	<b>37.5</b>
Petroleum Oil Extract (Bright stock)	<b>3.0</b>	—	— 10.0
GR-S (Buna-S synthetic rubber)	—	8.0	<b>6.0</b>
Sulfur monochloride (S <sub>2</sub> Cl <sub>2</sub> )	—	<b>0.2 (add)</b>	<b>0.2 (add)</b>

acrylic acid content, a high soap content, a high concentration of gelling agent, a low water content, and the use of gasoline which has a low aniline point. With a reasonably stable basic formula, the most important factors appear to be the nature of the gasoline and the strength and concentration of the gelling agent. High temperature stability is favored by a high polymer content, a high stearic acid content, and the use of concentrated solutions of the gelling agent, i.e., a low water content. The presence of oxygenated solvents destroys high temperature stability.

In order to increase the effectiveness of the incendiary filling in starting fires in targets more difficult to ignite, a complex filling was developed having as its main constituent "goop", a mixture of magnesium particles and asphalt. To this was added gasoline, thickened with IM oxidizing agents and magnesium scraps. PT-I composition, and the substitutes PT-2 and PT-3, used synthetic rubber instead of IM and an aluminum-magnesium alloy in place of "goop". (See Table 5-12.)

#### 5-4.2.2.3 Other Incendiaries

Phosphorus and its compounds have been used as an incendiary against personnel and readily-ignitable materials. Burning phosphorus produces serious skin burns and tends to demoralize attacked

troops. Because white phosphorus has a low combustion temperature, it is relatively ineffective against any but the most easily ignitable targets. The alkali metals, especially sodium, have been used as incendiaries but the results have not been satisfactory.

#### 5-4.2.3 Typical Incendiary Devices

The principal military characteristic of an incendiary device is its ability to initiate combustion of material with which it comes in contact, and to provide the energy to maintain the combustion process and assist in enlarging the area over which combustion takes place. This characteristic is called fire raising power. Other military characteristics covering tactical use, provision of fire-fighting deterrents, and design details are also specified.

The four-pound magnesium alloy bomb, shown in Figure 5-II, was used during World War II in tremendous quantities. Its hexagonal shape adapted it to assembly in clusters for shipping and loading on planes. After dropping from the planes the bombs were separated from the clusters and widely dispersed in random manner. The explosive charge in the base was exploded by the heat, providing a deterrent to fighting the fire. Only a portion of

the bombs had the high explosive charge ;the others were constructed as shown in Figure 5-12.

A "fire bomb" using napalm-thickened gasoline as the incendiary filling is illustrated in Figure 5-13. An incendiary grenade, suitable either for combat use or for destruction of materiel, is illustrated in Figure 5-14. It is loaded with a thermate, and is provided with an igniting charge, specified as first fire mixture.

### 5-5 DELAY COMPOSITIONS AND HEAT POWDERS

Gasless pyrotechnic mixtures are used for producing a controlled amount of heat and for time delays in a number of military applications. These compositions, which are physical mixtures of certain metals with one or more powdered oxidizing agents, react at a predetermined rate when ignited by the application of heat or flame. Their combustion is characterized by high reaction temperatures and the formation of mainly solid products. Both the burning rate and calorific output can be varied over fairly wide ranges by controlling the properties and proportions of the ingredients. Since little gas is produced by the combustion of these mixtures, atmospheric oxygen is not required for combustion, and the reaction rate is not greatly influenced by pressure ; "gasless" compositions are particularly valuable for use in armament, e.g., in short delay bomb fuzes.

#### 5-5.1 PYROTECHNIC DELAYS

Some ordnance items are more effective if functioning is delayed for an interval of time after the initiating stimulus. While a variety of mechanical and electrical devices— have been employed for this purpose, a time delay can be obtained by incorporating a pyrotechnic delay element into an explosive train. The time delay, in this case, depends on the length and rate of burning of the delay composition. Time delays can also be obtained by controlling the rate of heat flow through a thermal barrier,<sup>30</sup> or by the rupture of a barrier by the build-up of gas pressure.<sup>31</sup>

##### 5-5.1.1 Delay Elements

A delay element is a self-contained pyrotechnic

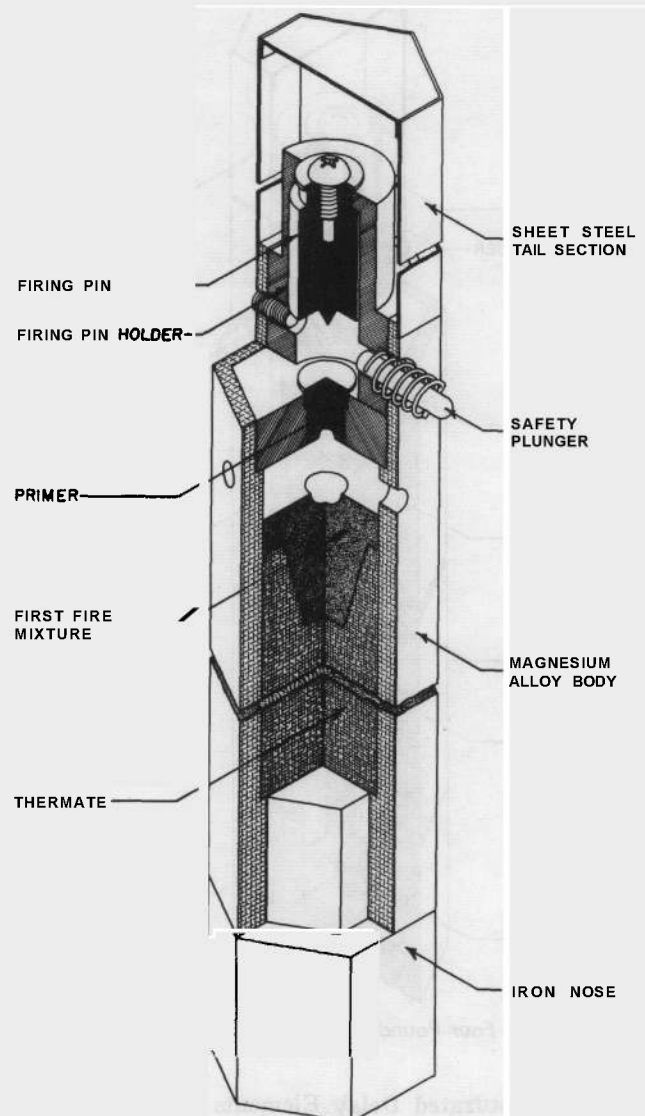

Figure 5-77. Four-Pound Magnesium Alloy Incendiary Bomb

device consisting of an initiator, delay column, and an output terminal charge or relay; all assembled into a specially designed inert housing. In some designs, one or more of these components may be omitted. In some cases, depending on the application and delay composition, the delay element may also include baffles, a housing, and provision for an internal free volume. Based on their construction, pyrotechnic delays can be subdivided into two general types, obturated or vented.<sup>29</sup>

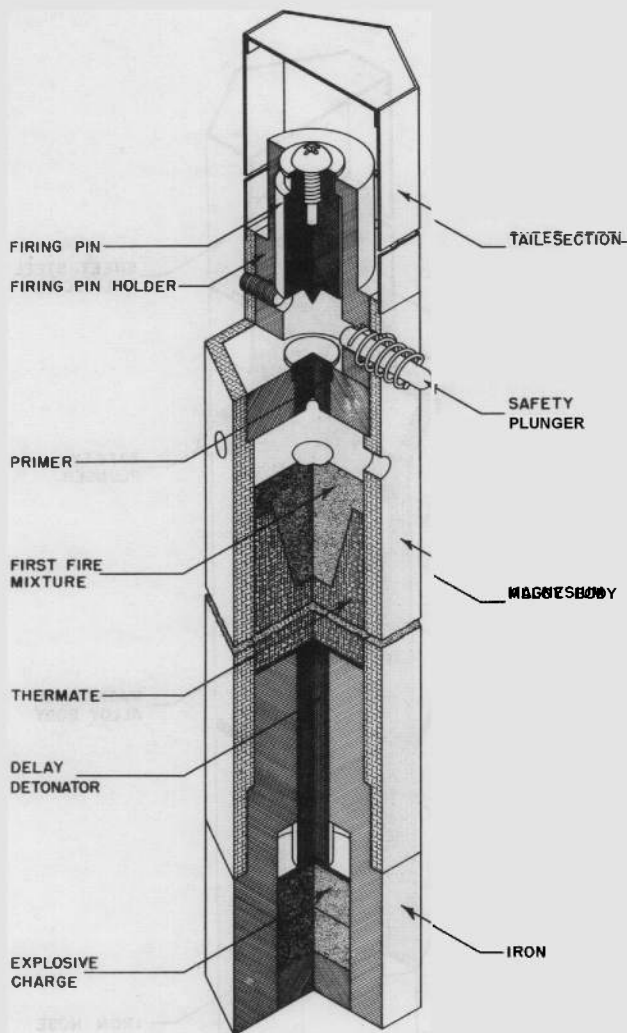

Figure 5-72. Four-Pound Thermite Incendiary Bomb

#### 5-5.1.1.1 Obturated Delay Elements

An obturated delay element, as shown in Figure 5-15, is constructed to contain all of the gases produced by the functioning of the initiator and delay composition before the functioning of the terminal charge. Delays in which the gases produced are internally vented into a closed chamber in the explosive device are considered to be obturated. Because they are sealed, obturated delays are not influenced by the effects of the ambient pressure or humidity. The combustion products are contained which prevents possible harm to other components of the device. Short time delays are often obturated as obturation tends to increase the average burning rate of the delay composition.

#### 5-5.1.1.2 Vented Delay Elements<sup>30,32</sup>

Vented delay elements have openings through which the gases produced by the functioning may escape. Vented delays are used when large quantities of gas are produced by the burning of the delay powder and may even be necessary for "gas-less" mixtures when long delay times are required in order to eliminate pressure buildup within the delay element. Venting exposes the burning delay composition to ambient pressure. As a consequence, the burning rate of the delay mixture is sensitive to changes in altitude. In addition, these vents require sealing up to the time of functioning in order to protect the delay composition from humidity. Two methods for sealing vented delays are illustrated in Figure 5-16.

Another vented delay is the time ring which consists, as shown in Figure 5-17, of a column of fuze powder which is pressed into the fuze cavity. Because of its construction, the ring delay occupies a large part of the total fuze volume. With a ring delay the delay time can be set to any desired value within its time range by rotating a calibrated ring which varies the length of the delay train that must be burned before the terminal charge functions.

#### 5-5.1.2 Delay Compositions

The delay compositions, being a critical part of the delay element, should ideally have certain characteristics which may be summarized as follows:

- a. The ingredients should be stable and non-hygroscopic; should have the highest purity consistent with requirements; should be readily available and inexpensive; and should be compatible with each other.
- b. The compositions should be capable of being blended, loaded, and assembled into an item with minimum risk from impact, friction, moisture, heat, and electrical discharge.
- e. They should be readily ignitable, and should change little in performance characteristics with small changes in percentages of ingredients. Their burning rates should be reproducible within each batch and from batch to batch with a minimum of variation.

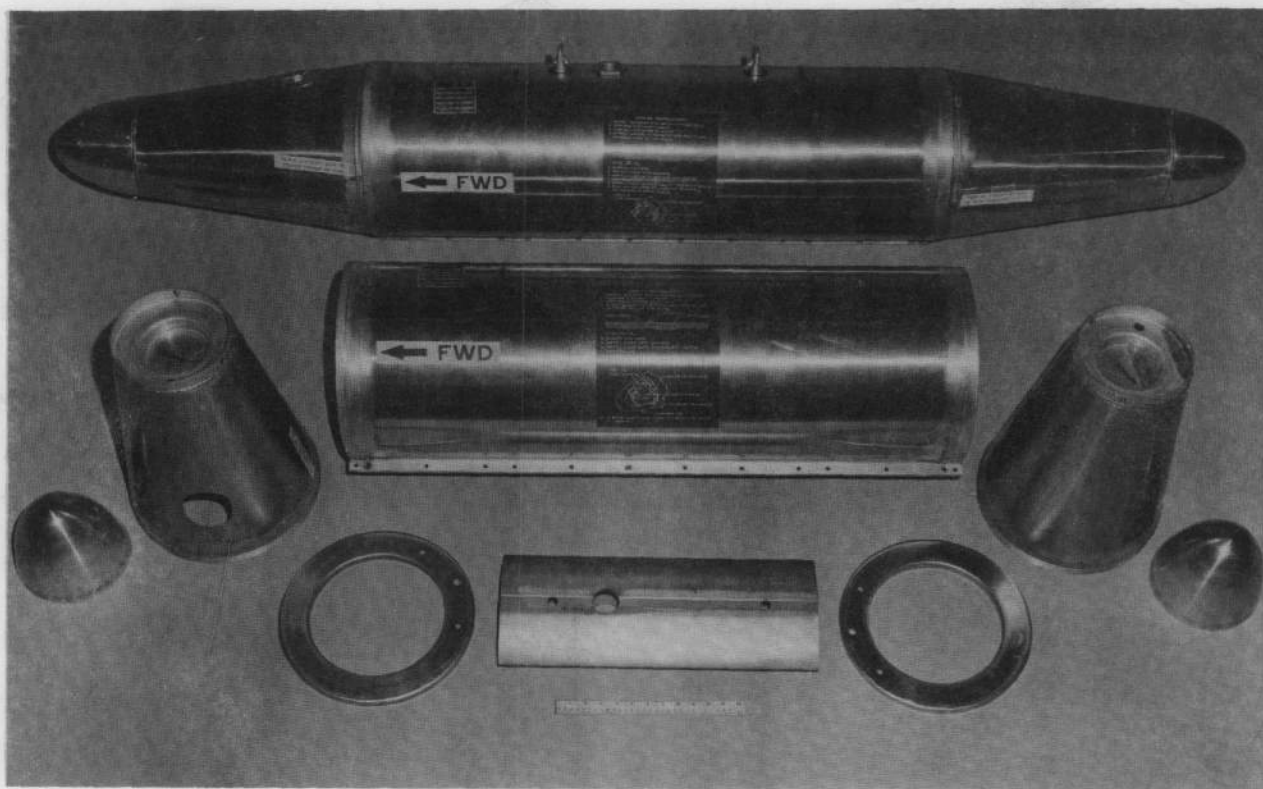

Figure 5-13. Typical Napalm Bomb

d. They should be compatible with their container as well as with other contacting compositions. Performance characteristics should not change appreciably with long term storage.

e. They should be relatively insensitive to changes in pressure and temperature.

f. They should be capable of withstanding the vibration and shock of transportation, setback, rotation, and impact, and should be resistant to physical abuse inherent in the loading, and firing of ammunition.

#### 5-5.1.2.1 Black Powder Delays

Black powder has been long and widely used as a delay material in spite of the fact that it does not meet many of the ideal characteristics for a delay composition. This popularity may be attrib-

uted largely to its good dry surveillance characteristics, its ease of ignition, its wide availability in reproducible quality and granulation, its ease of loading, and its versatility from the standpoint of delay times obtainable.

As already indicated, black powder produces gases on burning, and the burning rate is affected by pressure. Hence, the disposition of the gases is a primary consideration in design; delay elements using black powder are generally vented. The burning rate of black powder is affected by the rotational speed of the projectile and by the ambient pressure. A major shortcoming of black powder has been and still is its marked hygroscopicity. As has been indicated earlier, because of these undesirables, gasless delay compositions were developed.

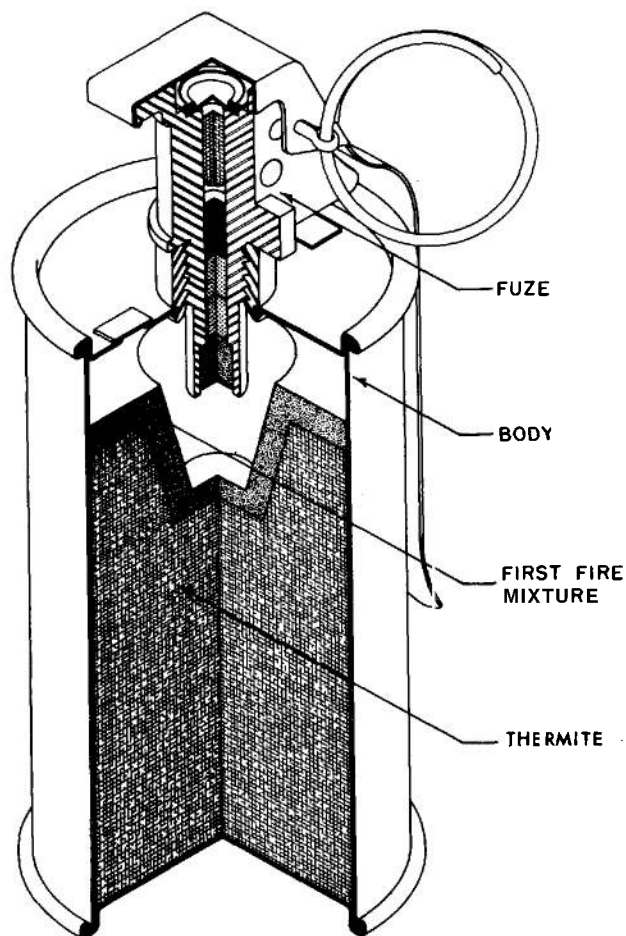

Figure 5-74. Typical Incendiary Grenade

#### 5-5.1.2.2 Typical Gasless Compositions

The gasless pyrotechnic mixtures which have been reasonably satisfactory for delays are given in Table 5-13. Different burning rates can be obtained by selecting a specific composition or by varying the proportions of ingredients in a composition.

The burning rates obtained with these compositions are given in Table 5-14. Under controlled laboratory conditions, the coefficient of variation of most of the compositions listed is three percent or less. Lot-to-lot variability may be compensated by adjusting the length of the delay column for each new lot of delay composition or by adding appropriate ingredients and remixing to speed up or slow down the mixture. Variation may be controlled by use of standardized raw materials and preparation procedures.

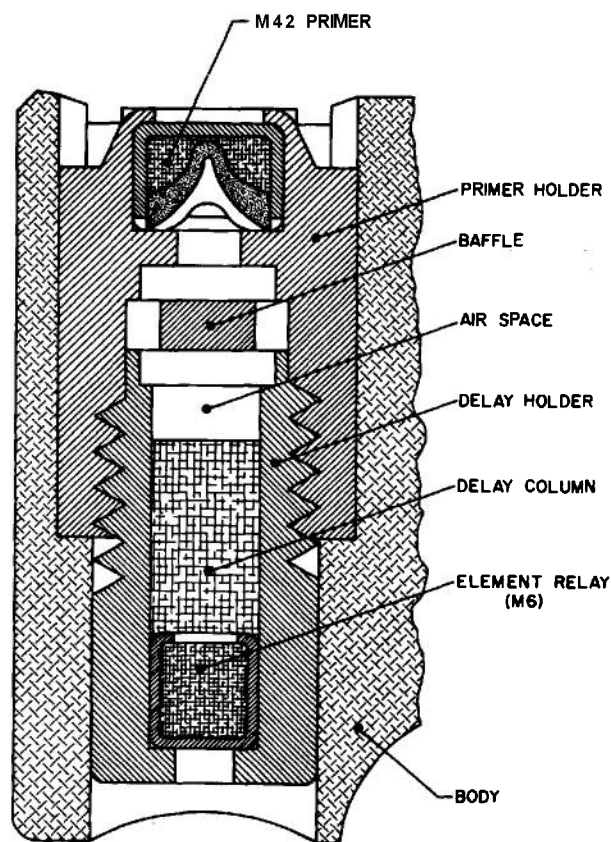

Figure 5-15. Obturated Delay Element

#### 5-5.1.3 Factors Affecting Performance<sup>36</sup>

The propagative burning of a pressed column of a gasless delay composition is a combustion reaction in which the fuel and oxidizer react to give essentially solid products. The gases formed consist mainly of hydrogen, water, nitrogen, carbon monoxide, carbon dioxide, and traces of organic materials.<sup>37</sup> These gaseous products are produced as a result of the presence of impurities or for other reasons not directly related to the primary reaction. The observed velocities of the reaction have been justified; however, quantitative agreement was purely on the basis of thermal flow.<sup>38,39</sup>

Questions have been raised concerning the details of burning of gasless delay compositions. For some compositions, there is evidence that the formation of a gaseous phase plays an important part in the overall reaction mechanism while condensed phase reactions are important in the pre-



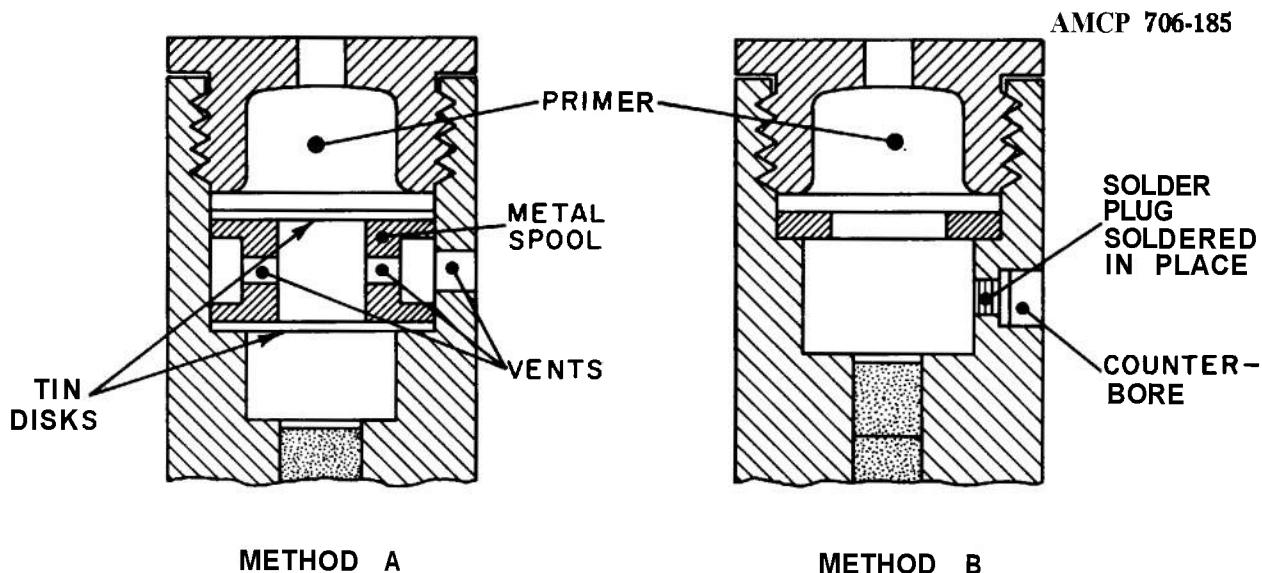

*Figure 5-76. Sealing of Vented Delay Element*

ignition reactions.<sup>39,40,41,42,43</sup> DTA and TGA studies of the ingredients in barium chromate-boron delay compositions do not, however, indicate the formation of a gaseous phase before ignition of the composition,<sup>44</sup> and that a gaseous phase may not be important, at least in this particular reaction.

In some cases the effectiveness of an explosive train depends greatly on the accuracy of the time delay produced by the burning of a delay column. While it is possible under controlled laboratory conditions to obtain coefficients of variation (Paragraph 5-5.1.2.2), less than three percent for many delay mixtures, the effect of ambient conditions and manufacturing variation in many cases is somewhat less than desirable. Factors which may influence the accuracy of a gasless pyrotechnic include :

- a. Composition and Quantity of Charge
- b. External Pressure
- c. External Temperature
- d. Terminal Charge
- e. Particle Size
- f. Ignition
- g. Column Diameter
- h. Loading Pressure
- i. Housing Material
- j. Acceleration
- k. Storage
- l. Processing

#### 5-5.1.3.1 Composition

There are a large number of exothermal reactions between inorganic solids which yield little or no gaseous products. However, most of the reactions are not satisfactory for one or more of the following reasons :

- a. Erratic burning rates
- b. Large column diameter required for reliable propagation
- c. Large temperature coefficient of burning rate
- d. Failure at low temperatures
- e. Hygroscopicity
- f. Rapid deterioration
- g. Unavailability of reproducible supply of raw materials
- h. Large pressure coefficient of burning rate
- i. Failure at low pressure

Reactions which were studied are summarized in Table 5-15.<sup>24</sup> Under the standardized conditions for these tests, it was found that for each oxidizing agent used, very fast burning times were obtained with magnesium, aluminum, zirconium, and titanium. Slower burning times were obtained with silicon, manganese, and chromium ; while still slower ones occurred with iron, tungsten, and others. Metals which gave fast burning times with silver oxide, silver chromate, barium peroxide, and lead chromate gave slower burning times with cuprous oxide, barium chromate, and iron oxide.

The variation in burning rate for the barium

**TABLE 5-13**  
**GASLESS DELAY COMPOSITIONS IN CURRENT USE<sup>33,34,35,50,51</sup>**

<i>Fuel, %</i>	<i>Oxidants, %</i>		<i>Inert, %</i>
Manganese <b>30 to 45</b>	Barium Chromate 0 to 40	Lead Chromate 26 to 55	None
Boron 4 to 11 <b>13 to 15</b>	Barium Chromate 89 to 96 <b>40 to 44</b>	Chromic Oxide — <b>41 to 46</b>	None
Nickel-Zirconium Alloy 26	Barium Chromate <b>60</b>	Potassium Perchlorate <b>14</b>	None
Nickel-Zirconium Mix <b>5/31</b> <b>5/17</b>	Barium Chromate 22 <b>70</b>	Potassium Perchlorate 42 8	None
Tungsten <b>27 to 39</b> <b>39 to 87</b> 20 to 50	Barium Chromate 59 to 46 46 to 5 <b>70 to 40</b>	Potassium Perchlorate <b>9.6</b> 4.8 <b>10</b>	Diatomaceous earth 5 to 12 <b>3 to 10</b>
Molybdenum 20 to <b>30</b>	Barium Chromate <b>70 to 60</b>	Potassium Perchlorate <b>10</b>	
Silicon <b>20</b>	Red Lead 80		Diatomaceous earth Max 8 parts by weight
Zirconium 28	Lead Dioxide 72		

chromate-boron system as the percentage of boron in the composition was increased to 50 percent is summarized in Table 5-16.<sup>33</sup> As indicated by the data presented in this table, a sharp drop in burning time is obtained initially as the percentage of boron is increased. At approximately 10 percent boron, the burning rate levels off and remains nearly constant to approximately 25 percent boron, when it begins to decrease quite rapidly. The heat of reaction reaches a maximum at approximately 13 percent boron, which is a somewhat lower percentage than that composition (19 percent) producing the maximum burning rate. A plot of total heat evolved against burning times, Figure

5-18,<sup>33</sup> indicates that compositions with less than 11 percent boron burn slower than those containing more than 13 percent boron when the amount of heat evolved is the same.

#### 5-5.1.3.2 External Pressure

As shown in Figure 5-19 for a 95.476 barium chromate-4.6% boron composition, an increase in the external pressure resulted in a decrease in burning times (an increase in burning rate). The relationship is hyperbolic and can be represented by an equation of the form:

$$t = ap^n \quad (5-11)$$

**TABLE 5-14**  
**BURNING RATES OF GASLESS DELAY COMPOSITIONS**<sup>33-36,51,52</sup>

<i>Composition</i>	<i>Inverse Burning Rate, sec/in.</i>
BaCrO <sub>4</sub> /B (amorphous)	0.5-3.5
95/5	1.5
90/10	0.6
BaCrO <sub>4</sub> /B (crystalline)	9-12.5
BaCrO <sub>4</sub> /KClO <sub>4</sub> /Zr-Ni (70-30)/Zr-Ni (30-70)	3-11
60/14/9 (70-30)/17 (30-70)	6
60/14/3 (70-30)/23 (30-70)	11
BaCrO <sub>4</sub> /PbCrO <sub>4</sub> /Mn	2.5-12.5
30/37/33	9.45
35/33/42	12.5
Red Lead/Si/Celite	4-11
80/20/3 to 7 added	
Zr/Ni/BaCrO <sub>4</sub> /KClO <sub>4</sub>	
5/31/42/22	6.5
5/17/70/8	17.5
BaO <sub>2</sub> /Se/Talc	
84/16/05 added	2.3 (approx)
PbO <sub>2</sub> /Zr	
28/72	< 0.5
BaCrO <sub>2</sub> /Cr <sub>2</sub> O <sub>3</sub> /B	4.5-8.5
44/41/15	4.5 (approx)
44/42/14	6.5 (approx)
BaCrO <sub>4</sub> /KClO <sub>4</sub> /W	
40/10/50	12.5 (approx)
60/10/30	31 (approx)
32/5/58	1
4115/49	10
58/10/27	40

where  $t$  is the burning time in seconds,  $p$  is pressure in pounds per square inch, and  $a$  and  $n$  are constants. The numerical values of the constants are  $n = 0.13$  and  $a = 2.52$  for the 95.4/4.6 barium chromate-boron composition.

No significant change was found, see Figure 5-19, in the burning times for a 90/10 and 81/19 barium chromate-boron composition for pressures less than atmospheric.

Results obtained with other delay mixtures also indicated that the burning rate would increase

\* 2 rounds not ignited.

slightly with increasing pressure above atmospheric. Results with mixtures which contained manganese, cobalt and a nickel-zirconium mixture as the fuel indicated that a change in composition of the atmosphere did not have a significant effect on the burning rate.<sup>45</sup>

### 5-5.1.3.3 External Temperature

As shown in Figure 5-20, the burning times for delay compositions were found to decrease with increasing temperature. For 90/10 barium chromate-boron, a plot of burning rate against the

TABLE 5-15  
HEATS OF REACTION OF INORGANIC MIXTURES  
CONSIDERED FOR DELAYS

Metals	Silver Oxide		Silver Chromate		Barium Peroxide		Lead Chromate		Cuprous Oxide		Barium Chromate		Iron Oxide	
	$-\Delta H^\circ$	$-\Delta H^\circ/n$	$-AH''$	$-\Delta H^\circ/\tau$	$-\Delta H^\circ$	$-\Delta H^\circ/\tau$	$-\Delta H^\circ$	$-\Delta H^\circ/\tau$	$-\Delta H^\circ$	$-\Delta H^\circ/n$	$-\Delta H^\circ$	$-\Delta H^\circ/\tau$	$-\Delta H^\circ$	$-\Delta H^\circ/n$
MAGNESIUM	139.1	69.6(I)	688.5	68.9(I)	126.7	63.4(I)	560.7	56.1(I)	103.6	51.8(5)	292.9	48.8(5)	239.8	40.0
ALUMINUM	378.0	63.0	1869.0	62.3	340.8	56.8(I)	1485.6	49.5	271.5	45.3	253.6	42.3(N)	200.5	33.4
ZIRCONIUM	244.1	61.0	1206.5	60.3	219.7	54.9(I)	950.9	47.5	173.1	43.3	483.5	40.3	377.3	31.4
TITANIUM	211.0	52.8	1041.0	52.1	186.2	46.6(I)	785.4	39.3(5)	140.0	35.0	384.2	32.0	278.0	23.2
SILICON	187.0	46.8	921	46.1(N)	164.8	41.2(I)	665.4	33.3'	116.0	29.0(N)	312.2	26.0(12)	206.0	17.2(N)
MANGANESE	89.5	44.8	440.5	44.1	77.1	38.6(4)	312.7	31.3	54.0	27.0(10)	144.1	24.0(23)	91.0	15.2(N)
CHROMIUM	252	42.0(N)	1239	41.3(N)	214.8	35.8(5)	855.6	28.5	145.5	24.3	63.8	21.3	74.5	12.4
ZINC	76.5	38.3	374.5	37.5	63.9	32.0	247.7	24.8	41.0	20.5	104.6	17.4	52.0	8.7
TIN	124.1	31.0	606.5	30.3	99.3	24.8	350.9	17.5	53.1	13.3	123.5	10.3	17.3	1.4
IRON	177.5	29.6(8)	866.5	28.9(8)	140.3	23.4	483.1	16.1(11)	71.0	11.8(N)	53.1	8.9(N)	0	0
CADMIUM	58.2	29.1	284	28.4	45.8	22.9	156.2	15.6	22.7	11.4	50.2	8.4	-2.9	-0.5
TUNGSTEN	174.7	29.1	852.5	28.4	137.5	22.9	469.1	15.6	68.2	11.4	50.3	8.4		
MOLYBDENUM	155.5	25.9	759	25.2	118.3	19.7	373.1	12.4(17)	49.0	8.2	31.1	5.2		
NICKEL	50.5	25.3	260.0	25.0	39.0	19.5	122.2	12.2	15.9	8.0	29.8	5.0		
COBALT	51.4	25.7	245.5	24.6	38.1	19.1	117.7	11.8	15.0	7.5	27.1	4.5		
ANTIMONY	145	24.2	704.0	23.5(10)	107.8	18.0(6)	320.6	10.7	38.5	6.4	20.6	3.4		
BISMUTH	116.1	19.4	544.0	18.1	78.9	13.2	176.1	5.9	9.6	1.6	-8.3	-1.4		
COPPER	31.5	15.8	150.5	15.1	16.4	8.2	22.7	2.3			-29.9	-5.0		
NONMETALS														
PHOSPHORUS	195	39(I)	192.4	38.5(I)	487.6	48.8(I)	128.4	25.7(2)	213	21.3	552.8	18.4(6)	35.3	7.1(15)
SULFUR	142.1	23.7	682.5	22.8(4)	158.2	26.4(4)	101.2	16.9(9)	95.9	4.8	28.8	4.8	-15.1	-0.5
SELENIUM	67.9	11.3	311.5	10.4	86.6	14.4	31.3	5.2	-6.2	-0.3				

$-\Delta H^\circ$  HEAT OF REACTION.

$-\Delta H^\circ/n$  EQUIVALENT HEAT OF REACTION (HEAT OF REACTION PER ELECTRON CHARGE).

(N) NO REACTION OBSERVED.

(I) VERY FAST BURNING RATE.

( ) BURNING TIME, SECONDS

logarithm of the absolute temperature results in a straight line. For the 95.4/4.6 compositions, this is also true for most of the temperature range; however, for some 95.4/4.6 compositions, there is a departure from this type of relationship at the lower temperatures. Over the narrower temperature range ( $-60^\circ\text{F}$  to  $160^\circ\text{F}$ ), the burning rate is essentially a linear function of the  $\log_{10}$  temperature.

#### 5-5.1.3.4 Terminal Charge, Anticipatory Effect<sup>46</sup>

The burning characteristics of pressed delay compositions are different when loaded above a thermally-sensitive terminal charge. The overall burning time and the reproducibility are both decreased under these conditions. This anticipatory effect has been observed with a variety of thermally-sensitive terminal charges for both gaseous and nongaseous delay compositions. The effect has also been observed for typical end item delay elements having a lead styphnate-lead azide relay.

The extent of the reduction in burning time that occurs with delay elements having thermally-sensitive terminal charges, compared with similarly pressed delay columns without a terminal charge, approaches a constant value as the length of the delay column above the terminal charge increases.

The magnitude of this reduction in burning time for several barium chromate-boron compositions is a function of the burning rate of the composition. (See Table 5-17.) As shown in Table 5-18 the reduction in burning rate is less for the more rapid burning compositions. Obturation of the delay column substantially increases the magnitude of the anticipatory effect. The anticipatory effect is reduced by barriers, between the delay column and the thermally-sensitive terminal charge, which would reduce the flow of gases. The importance of gas permeation in the burning of pressed delay compositions is indicated.

#### 5-5.1.3.5 Particle Size

The effect of particle size on the inverse burning rates of delay compositions follow a nearly direct proportionality. In addition to increasing the burning rate, reduction of the particle size tends to reduce the effects of temperature and pressure. This effect is shown to a marked degree by tungsten delay compositions, as is shown in Table 5-19. Although the percentage compositions are not identical, they are close enough that little difference in burning time would be observed if the tungsten fuel had the same surface area. The weight, average diameter, and the surface area

TABLE 5-16  
EFFECT OF PERCENT COMPOSITION ON BURNING TIME,  
HEAT OF REACTION, AND IMPACT VALUES  
OF THE BARIUM CHROMATE-BORON SYSTEM

% Boron	Charge Wt, mg	No. Results Avg and Range based on	Avg Burning Time, sec	Range, sec	Range, sec/sec B. T.			Total Cal in Loaded Fuze	Cal/sec	Impact Test PA, inches
						Cal/g	Volume gas ml/g			
3.0%	2130	5	7.56	0.469	0.620		Incomplete reaction			40+
3.5%	2150	4	3.54	0.070	0.020	278	5.0	597	169	40+
4.0%	2140	4	1.72	0.031	0.018	354	5.0	768	446	40+
4.5%	2125	5	1.44	0.040	0.028	400	4.0	850	590	39
5.0%	2130	5	1.09	0.035	0.032	420	8.0	895	821	40+
6.0%	2110	5	0.767	0.021	0.027	231	8.4	909	1186	37
7.0%	2000	4	0.653	0.010	0.015	453	6.4	906	1387	38
8.0%	2000	4	0.560	0.001	0.002	462	7.9	924	1650	28
9.0%	2000	4	0.539	0.002	0.004	474	7.5	948	1758	29
10.0%	1975	4	0.465	0.015	0.032	515	7.3	1017	2187	21
11.0%	1925	4	0.432	0.020	0.046	536	6.9	1032	2388	18
13.0%	1900	4	0.397	0.006	0.015	556	8.9	1056	2661	20
15.0%	1875	4	0.382	0.027	0.071	551	7.0	1033	2704	16
17.0%	1800	4	0.375	0.027	0.072	543	11.6	977	2606	13
19.0%	1750	4	0.366	0.021	0.057	535	8.8	936	2558	16
21.0%	1685	4	0.375	0.007	0.019	526	8.6	886	2363	34
23.0%	1650	4	0.407	0.023	0.057	503	4.2	830	2703	40
25.0%	1625	4	0.433	0.025	0.058	497	10.2	808	1865	40+
30.0%	1611	4	0.574	0.025	0.044	473	10.4	762	1328	40+
35.0%	1500	4	0.965	0.115	0.119	446	12.7	669	693	40+
40.0%	1430	4	2.19	0.110	0.050	399	14.1	571	261	40+
45.0%	1360	3	5.25*	0.210	0.040	364	15.0	495	94	40+
50.0%	1290	2	14.5*	1.000	0.069			Incomplete reaction		40+

\*2 rounds not ignited

were determined on the micromerograph. Under these experimental conditions, a fuel with about twice the surface area will have a linear burning time of about one-fifth of the former.

For the 90/10 barium chromate-boron composition, the use of boron of 1, 13.5, and 53 micron average particle size resulted in an increase in the inverse burning rate of 0.45, 6.61 and 9.53 seconds per inch, respectively. Similar results were observed for manganese delays.<sup>35</sup>

In addition to the average particle size, the particle size distribution and blending of delay mixtures is important if reproducible burning rates are to be obtained.<sup>47</sup> For the barium chromate-boron composition, there appears to be little difference between delay mixtures produced by wet and dry blending methods. Wet blending is preferred for safety reasons.

#### 5-5.1.3.6 Ignition Compositions

Some gasless delay compositions are difficult to ignite. It is the usual practice to press a small

charge of an igniter composition on top of the delay column, which is easy to ignite and is capable, in minimum quantities, of igniting the delay column. The complex interactions between initiating source and igniter and, in turn, igniter and main charge are yet to be determined. For the most part, igniters have been and still are selected on an arbitrary basis. Compositions of some of the ignition powders which have proved relatively satisfactory are given in Table 5-20. These mixtures are also gasless.

#### 5-5.1.3.7 Column Diameter

Radial losses of heat can retard or extinguish the reaction in a delay column. Such losses become more serious as the column diameter, burning rate, and ambient temperature are reduced. These effects combine to result in a failure diameter associated with a given delay mix for a given ambient condition. For manganese delay compositions at  $-65^{\circ}\text{F}$ , the failure diameter for a three-second per inch composition is less than 0.109 inch;

**TABLE 5-17**  
**EXTENT OF ANTICIPATORY EFFECT AS A FUNCTION OF**  
**BURNING RATE OF VARIOUS BARIUM CHROMATE-BORON**

	Average Burning Time, msec		
	95/5	90/10	86/14
Delay composition alone	464	167	132
Delay composition above terminally pressed 100-mg increment of SI-98	<u>158</u>	<u>124</u>	<u>116</u>
Burning time reduction, msec	306	43	16

SI-98 squibs were employed for initiation of columns. Composition loaded in M112 fuze housings at 36,000 psi.  
 SI-98 Composition:  
 MoO<sub>3</sub>—26%  
 KClO<sub>4</sub>—21%  
 Zr—53%

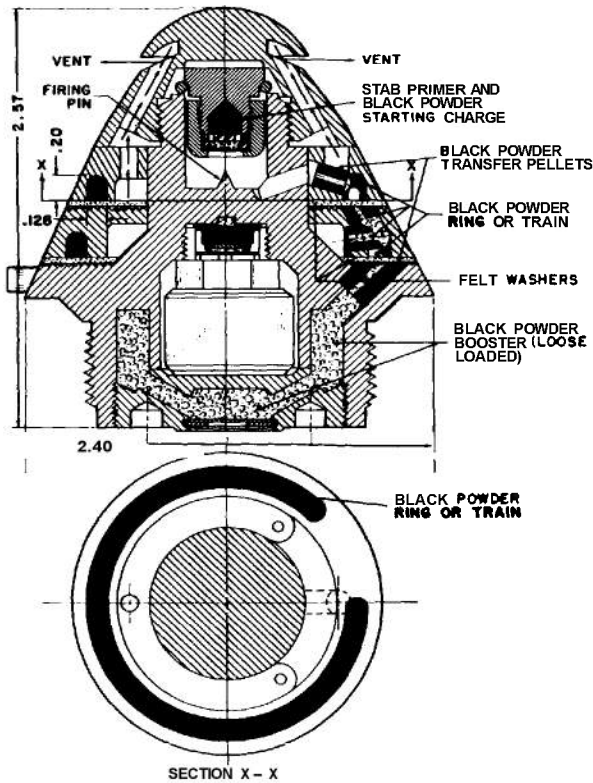

Delay Type: Ring or Train; Vented; Without Baffle.  
 Time: Selective; 1 to 21 Seconds.  
 loading:  
 Upper Ring—3.185 Grams.  
 Lower Ring—3.640 Grams.  
 A-7 Black Powder, loaded in Place in Single Increment at 68,000 psi.

Figure 5-77. Time Delay Ring or Train, Vented

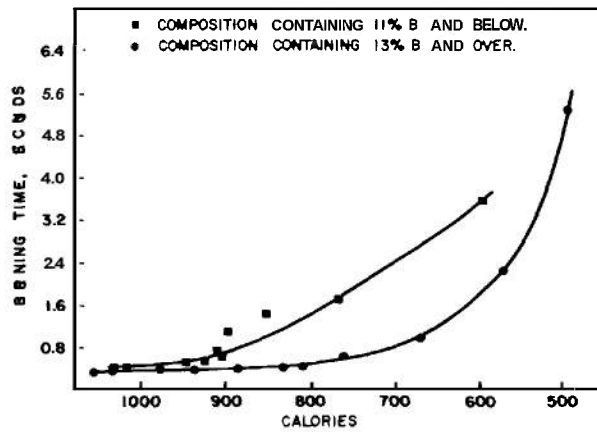

Figure 5-78. Total Heat Evolved Versus Burning Time of Binary Barium Chromate-Boron Compositions Loaded to a Height of 0.79 Inch in M112 Fuze Housing at 36,000 psi

that of a ten-second per inch mix is between 0.125 and 0.156 inch, while for a 12.5-second per inch composition, the failure diameter is between 0.156 and 0.203 inch. As shown in Table 5-21, the effect of column diameter was found to be significant for all 95/5 barium chromate-boron delay systems and for obturated 90/10 barium chromate-boron delay systems.

**5-5.1.3.8 Loading Pressure**

Burning rates of delay mixtures will decrease as the consolidation pressure increases. The rather small and systematic changes with loading pressure for barium chromate-boron composition are

TABLE 5-18  
EXTENT OF ANTICIPATORY EFFECT AS A FUNCTION OF  
COLUMN LENGTH 55/35/10 TUNGSTEN-BARIUM CHROMATE-  
POTASSIUM CHROMATE COMPOSITION\*

	Average Burning Time,*** msec	Burning Time Range, msec	Percent A Range	Burning Time	% Column By-passed	Length of Column By-passed, in.
One 1000-mg increment						
Without terminal charge	2348	411	18			
With terminal charge**	1473	462	31	875	37	0.07
Two 1000-mg increments						
Without terminal charge	4291	259	6			
With terminal charge	3404	583	17	887	21	0.09
Three 1000-mg increments						
Without terminal charge	6082	328	5		15	
With terminal charge	5192	1042	20	890		0.09
Four 860-mg increments						
Without terminal charge	6914	337	5			
With terminal charge	6173	990	16	741	11	0.08

\* SI-98 squibs were employed for initiation of columns. The compositions was loaded in M112 fuze housings at 36,000 psi.

\*\* SI-98 terminal charges were used.

\*\*\*Average burning time values have been reduced by 6 msec in order to take into account the burning time of the terminal charge itself.

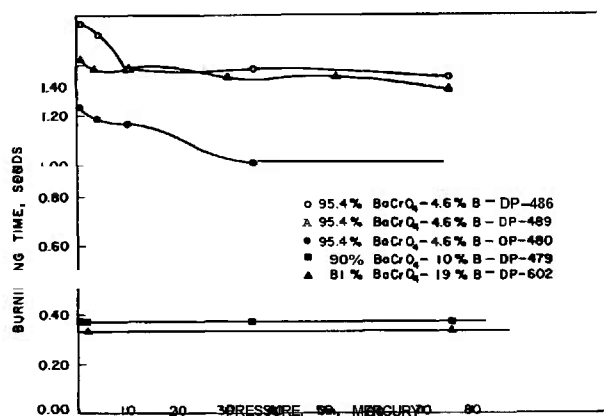

Figure 5-79. Burning Time of M112 Fuze Versus External Pressure

summarized in Table 5-22.<sup>40</sup> These effects might be used to compensate for the differences in burning rate from lot to lot. However, this method has not been used due to the established practice of loading delays at pressures between 30,000 and 40,000 psi in order to withstand the forces to which it is subjected in use. Yielding of the delay element while pressing the delay composition will cause erratic delay times.

#### 5-5.1.3.9 Housing Material

The body into which a delay composition is loaded serves as a heat sink, as metals in general are much better conductors of heat than delay compositions. Delay columns close to their low-temperature failure diameters tend to have larger temperature coefficients as the surrounding wall thickness is increased. For materials well above

TABLE 5-19  
EFFECT OF SPECIFIC SURFACE ON BURNING  
TIME OF TUNGSTEN DELAY COMPOSITIONS

<i>Type of Tungsten Composition</i>	<i>M10</i>	<i>ND 3499</i>	
Fuel Characteristics	Surface Area cm <sup>2</sup> /g	1377	709
	Weight Average Diameter, microns	2.3	4.9
Delay Composition, %	Tungsten	40	38.0
	BaCrO <sub>4</sub>	51.8	52.0
	KClO <sub>4</sub>	4.8	4.8
	Diatomaceous Earth	3.4	5.2
Burning Time, sec/inch	4.17	21.5	

TABLE 5-20  
IGNITION POWDERS FOR GASLESS DELAY ELEMENTS

<i>Fuel, %</i>	<i>Oxidants, %</i>	<i>Inert, %</i>
Zirconium 65	Ferric Oxide 25	Diatomaceous Earth 10
Boron 10	Barium Chromate 90	
Zirconium 33 Titanium 17	Ferric Oxide 50	
Zirconium 51	Ferric Oxide 39	Diatomaceous Earth 10
Boron 30	Lead Peroxide 70	



**TABLE 5-21**  
**EFFECT OF FUZE HOUSING MATERIAL AND DIMENSIONS ON BURNING TIME**  
**OF BARIUM CHROMATE-BORON COMPOSITIONS**

<i>Parameters</i>	<i>Effect</i>
1. <i>Metal Housings</i>	
a. Aluminum, Brass and Stainless Steel	<ul style="list-style-type: none"> <li>a. No effect on burning times over test temperatures, internal diameter, wall thickness and for either vented or obturated columns.</li> <li>b. No interaction between metal and composition.</li> </ul>
2. <i>Internal Diameter, inch</i>	
a. 0.250 95/5 vented vs obturated	<ul style="list-style-type: none"> <li>a. Results for vented columns significantly different at 95% confidence level.</li> </ul>
b. 0.375 95/5 vented vs obturated	<ul style="list-style-type: none"> <li>b. Results for obturated columns significantly different at 95% confidence level.</li> </ul>
c. 0.250 90/10 vented vs obturated	<ul style="list-style-type: none"> <li>c. No significant difference for either column at this diameter.</li> </ul>
d. 0.375 90/10 vented vs obturated	<ul style="list-style-type: none"> <li>d. Results for obturated column significantly different at 95% confidence level.</li> </ul>
3. <i>Temperature, °C</i>	
a. — 54, Room Temperature, and 76	<ul style="list-style-type: none"> <li>a. The effect of temperature was significantly different at the 95% confidence level for all metals, internal diameters, wall thickness and for vented and obturated columns.</li> </ul>
4. <i>Wall Thickness, inch (0.05, 0.15, 0.30, 0.50, 0.75, and 1.00)</i>	
a. 95/5 vented and obturated columns	<ul style="list-style-type: none"> <li>a. Results for different wall thickness were significantly different, although no apparent trend was observed.</li> </ul>
b. 90/10 vented and obturated columns	<ul style="list-style-type: none"> <li>b. No significant differences or trends in results due to wall thickness for either type of column.</li> </ul>

**TABLE 5-22**  
**EFFECT OF LOADING PRESSURE ON BARIUM CHROMATE-BORON COMPOSITIONS**

Loading Pressure (10 <sup>3</sup> psi)	95/5 BaCrO <sub>4</sub> -B					
	36	18	9	3.6	1.3	0.5
Mean BR, sec/inch*	1.69	1.60	1.49	1.39	1.29	1.21
Mean BR, sec/gram	0.648	0.655	0.645	0.642	0.646	0.693
% Coefficient of Variation	1.2	0.6	0.7	0.7	0.8	0.8
	90/10 BaCrO <sub>4</sub> -B					
Mean BR, sec/inch	0.671	0.653	0.619	0.586	0.558	0.544
Mean BR, sec/gram	0.272	0.276	0.280	0.287	0.297	2.309
% Coefficient of Variation	1.5	0.9	1.1	1.6	2.0	1.8

\* BR = burning rate,

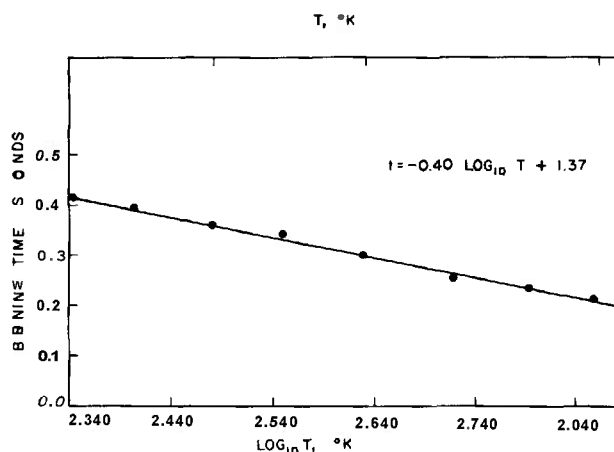

Figure 5-20. Burning Time of M112 Fuze Containing 90% Barium Chromate-10% Boron Composition Versus Logarithm of Absolute Temperature

their failure diameters, the effect of wall thickness becomes less important.<sup>32</sup> As shown in Table 5-21 for the 95/5 barium chromate-boron composition, the wall thickness had a significant effect for both vented and obturated items; however, the differences observed were small and had no apparent trend. No significant difference due to wall thickness was noted for the 90/10 barium chromate-boron compositions.<sup>48</sup>

As also shown in Table 5-21, the material used for the housing did not appreciably affect the burning rate of barium chromate-boron composition. \*

Delay compositions have been loaded and consolidated into lead tubing by a swaging technique. The accuracy of delays prepared by the lead-tube method depends on many factors associated with the composition, application, etc. However, it may be said that in some applications it is more accurate and in others less accurate than the conventional method of filling.<sup>49</sup>

#### 5-5.1.3.10 Acceleration

Delay elements are often subjected to very high accelerations while the delay composition is burning, as in skip bombing. If the structure of the material at or behind the reaction front is too weak, the accelerations may cause the hot products to lose contact with the unburned delay composi-

tion or a subsequent charge and extinguish the reaction. Quantitative data regarding the resistance of delay compositions to this type of failure are not available. "Slag retention," i.e., the fraction of the weight of the original charge remaining in an open ended delay column after functioning, has been used as a possible qualitative indication of the resistance of a delay element to acceleration forces. Slag retention for some delay compositions is as follows: manganese, > 95%; red lead, 90%-95%; tungsten, > 95%; nickel-zirconium, 80%-90%; boron, 59%-90%.<sup>34</sup>

Introduction of a binder will improve performance under high acceleration conditions; however, binders tend to produce sufficiently large amounts of gaseous products so that the system could no longer be considered gaseous. Mechanical support of the delay column at both ends tends to reduce variation in burning times by minimizing slag flow.

#### 5-5.1.3.11 Storage

The effectiveness of an item of ammunition may depend greatly on accuracy of the delay. Because it is necessary to store ammunition for a long time, it is important to know the effect of storage on the burning times of delay compositions. In general, dry storage for relatively long periods of time results in little change in burning time. For example, barium chromate-boron compositions loaded and stored over a desiccant show little change after time intervals up to two years, as illustrated in Table 5-23. For loose powders stored up to two years in unheated magazines and then loaded, a slight increase in burning time has been observed. Storage under dry conditions prevents further increase in burning time and may reverse the trend as shown in Table 5-24.

When manganese delay mixtures are kept dry, their burning times will not increase more than five percent during eight weeks' storage at +165°F. Some mixtures containing manganese did not change their burning times when stored without sealing at 100 percent relative humidity and +165°F. Other manganese mixtures deteriorate rapidly under the same conditions. This wide variation in storage stability is due to differences in the manganese powder used in preparing them,

**TABLE 5-23**  
**EFFECT OF STORAGE ON FUZES LOADED WITH**  
**BARIUM CHROMATE-BORON COMPOSITIONS**

<b>Comp., % B</b>	<i>Zero Time</i>			<i>Stored 19 months</i>		
	<i>Mean B. T.,* Sec.</i>	<i>Std. Dev.</i>	<i>% Coef. Var.</i>	<i>Mean B. T.,* Sec.</i>	<i>Std. Dev.</i>	<i>% Coef. Var.</i>
10.0	0.514	0.013	2.5	0.515	0.025	4.9
10.0	0.590	0.012	2.0	0.579	0.012	2.2
10.0	0.519	0.015	3.0	0.476	0.010	<b>2.2</b>
10.0	0.574	0.004	0.8	0.522	0.012	2.2
5.0	1.590	0.015	0.9	1.587	0.020	1.3
5.0	1.075	0.016	1.5	1.059	0.015	1.4
5.0	1.294	0.026	2.0	1.264	0.019	1.5
5.0	0.818	0.016	2.0	0.785	0.016	2.0
5.0	1.192	0.036	3.0	1.277	0.016	1.3
5.0	0.986	0.033	3.4	0.955	0.014	1.4

M112 Fuzes loaded at 36,000 psi, stored over desiccant

\* B. T. = burning time.

**TABLE 5-24**  
**BURNING TIMES OF FUZES LOADED WITH 93/7 BARIUM**  
**CHROMATE-BORON COMPOSITIONS STORED LOOSE**  
**UNDER VARIOUS CONDITIONS**

<i>Initial Conditions</i>		<i>Storage Conditions</i>			
<i>Mean B. T.,* Sec.</i>	<i>% Coef. Var.</i>	<i>Temp.</i>	<i>Time</i>	<i>Mean B. T.,* Sec.</i>	<i>% Coef. Var.</i>
0.694	2.7	150°C	4 hours	0.707	<b>1.1</b>
			8 hours	0.722	1.0
		105°C	1 week	0.723	1.8
			50% RH	1 week	0.720
0.647	2.3	Desiccated	1 week	0.685	1.7
			150°C	4 hours	0.685

Compositions loaded in M112 Fuze Housings at 36,000 psi.

\* B. T. = burning time.

and, apparently, is associated with the manganese crystallite size and surface oxidation. Protective treatment of the manganese fuel against corrosion --oxidation of surface by dichromation and coating with a thin film of stearic acid—did not improve the dry surveillance properties of manganese delay powders but did improve the wet surveillance characteristics.

For zirconium-nickel delays, four weeks' dry surveillance increases burning times up to 16 percent. Wet surveillance for four weeks results in unreliable performance. Delay compositions of silicon and red lead exhibited increased burning times of up to 10 percent after four weeks' dry surveillance and were unreliable after four weeks' wet surveillance.

In general, results of tests indicate that gasless delays will exhibit changes of up to 15 percent in burning times after four weeks of dry surveillance. Wet surveillance appreciably affects performance of most delay mixtures, in some cases sufficiently to make the mixture unreliable.

### 5-5.2 HEAT POWDERS<sup>30</sup>

The majority of pyrotechnic heat powders have been developed for thermal battery applications to melt the solid electrolyte and activate the electrochemical system. In general, the heat powder—which generates between 350 and 500 calories per gram—is mixed with inorganic fibers and made into heat paper using conventional paper making techniques. The heat paper can be stamped into required shapes and easily assembled with the other battery components. Other uses include warming of battery electrolytes, melting of soldered joints to activate spring loaded mechanisms, and furnishing heat for thermal delays. Many gasless heat powders and gasless delay compositions can be used interchangeably; however, the electrical conductivity of the products formed during burning is important in the ability of heat powders to satisfactorily perform their function.

The heat output of a heat powder is of prime significance and the burning rate is important only to the extent of its influence on the heat output of the mixture. Other important characteristics include:

- a. Heat of reaction. Basically determines the heat output per unit weight of heat powder.
- b. Gas evolution. The gases evolved must be controlled because it is possible they will affect the behavior of the heat battery.
- c. Burning rate. Basically determines the rate of heat release by the heat mixture powder. (The burning rate of heat paper has been suggested as a means of obtaining a controlled delay time.)

### 5-6 INITIATORS, FIRST FIRES, AND STARTERS

The initiation of combustion of a pyrotechnic composition requires that a portion of the composition be raised to its ignition temperature. (See also Paragraph 3-3.6.1.) Since some pyrotechnic

compositions are relatively difficult to ignite, an explosive train similar to that used in other explosively loaded items is used to produce the ignition stimulus required to initiate the main pyrotechnic composition. Such a train can be considered as divided into three parts. The first part contains a sensitive initiating composition that can be initiated by a relatively small, mechanical, electrical, or chemical stimulus. This initiating composition, on burning, produces sufficient heat to initiate intermediate explosive or pyrotechnic composition(s) in the second part of the explosive train. The output of this second part will initiate the main charge in the third part of the explosive train.<sup>29,31,32</sup> In many cases, a delay train (see Paragraph 5-5.1) can be included in the second part of an explosive train. Emphasis in the following paragraphs will be on initiator, first fire, and starter compositions used in pyrotechnic items.

Work on the development of initiators, first fires and starters for military pyrotechnics has indicated that ignition is a complex phenomenon. Ignition failures of pyrotechnic items emphasized the need for more research and the need for more understanding of the ignition and combustion processes. The available compositions, with descriptions of their applications, are discussed in the paragraphs which follow.

#### 5-6.1 PRIME IGNITION<sup>50</sup>

Prime ignition is the starting of a fire without the use of another fire and includes methods based on friction, percussion, concentration of the sun's rays by mirrors or lenses, and an electric impulse.

Many materials and mixtures of materials have been found which produce heat as a result of chemical reaction and which require relatively little physical effort for initiation. Chemicals, such as white phosphorus and phosphorus-containing compounds, burst into flame on exposure to air. Other materials, including many metals which commonly will not ignite in air, become pyrophoric when finely ground; while other materials are activated by exposure to water or acid, to a spark with a small energy content, or to very slight impact. Still other mixtures require only a small and predictable amount of energy to be initiated. This

last group, which includes matches, is of importance as initiators for ordnance items.

Development of modern matches made fire-making a commonplace act. A safety match head is, essentially, potassium chlorate in a matrix of animal glue. The striking strip is composed of red phosphorus in a similar binder. Use of additives and adjustments in the manufacturing process results in a safety match which ignites easily when rubbed on the striking surface. The friction and contact of potassium chlorate crystals with red phosphorus results in the ignition of the match head which, in turn, causes the ignition of paraffin impregnated in the match splint. A typical match head formula, and that for the striker, are given in Tables 5-25 and 5-26.<sup>50</sup>

TABLE 5-25  
COMMERCIAL  
SAFETY MATCH COMPOSITION

<i>Ingredient</i>	<i>Percent*</i>
Animal (Hide) Glue.....	9-11
Extender (Starch, Dextrin).....	2-3
Sulfur (Rosin).....	3-5
Potassium Chlorate.....	45-55
Neutralizer (Zinc Oxide, Calcium Carbonate).....	45-55
Infusorial (Diatomaceous) Earth.....	5-6
Other Siliceous Filler.....	15-32

\* Fractional percentages of a soluble burning rate catalyst, such as potassium dichromate, are added, also soluble dye stuffs. Lead thiosulfate or zinc ferrocyanide can be used if the match head is to be white.

Present "strike-anywhere" (SAW) matches have a small, easily ignitable tip composed of tetraphosphorus trisulfide (phosphorus sesquisulfide) affixed to a larger bulb composed of a rather insensitive modified, safety match head composition. Table 5-27 gives the formulation for two such compositions.<sup>50</sup>

The match mixtures used in munitions are generally much less complicated in composition and manufacture than the commercial match mixtures which require a special striking surface. Compositions which have been widely used in friction primers for artillery are given in Table 5-28. A composition used in the friction primer for an

airplane flare contains 14 parts potassium chlorate and 1.6 parts charcoal hardened with 0.3 part dextrin. Ignition is effected by pulling a loop of braided wire coated with red phosphorus and shellac through a pellet of the composition.<sup>51</sup> Modified scratch sensitive mixtures containing some thermite produces very high temperatures and can ignite some smoke mixtures without an intermediate starter.<sup>8</sup>

In addition to matches and other scratch sensitive materials, prime ignition of pyrotechnic munitions, like other munitions, is accomplished with :

a. Percussion (or stab) primer which contains a mixture that is relatively sensitive to impact and friction, or

b. Electrically ignited primer (or squib) in which the heat produced by the flow of electric current in a bridgewire ignites a heat sensitive explosive. For certain applications, especially those involving initiation of high explosives, a bridgewire may be exploded by application of a high current pulse causing direct initiation of some less-sensitive explosives.<sup>29,31,32,52</sup>

Certain chemical reactions have been used for ignition of explosive trains. As has been indicated earlier, some materials burn when exposed to air. An example is white phosphorus. It has been used in bursters for jelled gasoline incendiaries where it serves the dual purpose of igniting the incendiary, and the reigniting jelled gasoline which has been extinguished. Diethyl zinc, or triethyl aluminum, contained in a glass vial, has been used to ignite a match mix in a silent igniter. Some materials, notably the alkali metals, react very vigorously with water, liberating hydrogen which is ignited by the heat of reaction. Bursters filled with sodium have been considered for igniting oil slicks on water.<sup>8</sup> The vigorous chemical reaction resulting from bringing iron powder, potassium permanganate, and sulfuric acid together is another method of prime ignition.

#### 5-6.2 CHARACTERISTICS OF IDEAL IGNITER, FIRST FIRE, AND STARTER COMPOSITIONS

The compositions used to ignite any burning-type pyrotechnic should have the following characteristics:<sup>53</sup>

**TABLE 5-26**  
**SAFETY MATCH STRIKER COMPOSITION**

<i>Ingredient</i>	<i>Formula 1,†</i> %	<i>Formula 2,†</i> %	<i>Formula 3,†</i> %
Binder	*	20	16
Red Phosphorus	53	50	50
Antimony Sulfide	42	—	—
Charcoal	5	—	—
Carbon Black	—	—	4
Neutralizer (ZnO, CaCO <sub>3</sub> )	—	—	—5
Sand	—	30	—
Powdered Glass	—	—	25

\* In NC laquer, Dextrin, Casein, Animal Glue, plus hardener of U.S. Pat. 2,722,484 129.

† Formulas 1 and 2 are "one-strike" military or firework strikers. Formula 3 is a commercial formula. Antimony sulfide and charcoal act as extenders to the phosphorus. Antimony sulfide also seems to fulfill the role of a neutralizer and preservative for red phosphorus.

**TABLE 5-27**  
**SAW ("STRIKE-ANYWHERE") MATCH COMPOSITION**

<i>Ingredient</i>	<i>Formula 1,*</i> %	<i>Formula 2,*</i> %
Animal Glue	11	12
Extender	4	5
Paraffin	—	2
Potassium Chlorate	32	37
Phosphorus Sesquisulfide (P <sub>4</sub> S <sub>3</sub> )	10	3
Sulfur	—	6
Rosin	4	6
Dammar Gum	—	3
Infusorial Earth	—	3
Powdered Glass and Other Filler	33	21½
Potassium Dichromate	—	1½
Zinc Oxide	6	1

\*Formula 1 represents the tip formula which ignites on any hard surface. Formula 2 is the match composition's base, loaded with combustibles for strong billowing flame but of low friction sensitivity.

- Be ignited by the primer, fuze, or match employed in the munition.
- Ignite the main pyrotechnic composition.
- Be sufficiently insensitive for safe handling in manufacturing and loading operations.
- Be resistant to the effect of moisture.

The specific nature of the ignition composition is primarily determined by the particular ignition problem since it involves the nature of the filling to be ignited and the method by which the ignition composition is ignited. The wide variety of fillings used in burning-type munitions makes it impossible

TABLE 5-28  
FRICTION PRIMER COMPOSITIONS

<i>Ingredient</i>	<i>Parts by Weight</i>	
Potassium Chlorate. ....	56.2	44.6
Antimony Sulfide. ....	24.6	44.6
Sulfur . ....	9.0	3.6
Meal Powder. ....		3.6
Ground Glass. ....	10.2	3.6

to develop one composition for all purposes. A composition producing a slag and a high temperature would be desirable for ignition of a thermite-type incendiary or most illuminating compositions, but would be unsatisfactory for ignition of a colored smoke since the high temperature would cause flaming of the dye.

Requirements for ignition compositions, therefore, must be varied depending on their use. Ignition mixtures can be classified as slag-producing or gas-producing mixtures. As some compositions produce both slag and gas, the type of filling to

be ignited appears to be the most practical basis for differentiation of the various compositions. Ignition compositions may be classified as those:

a. For munitions containing thermite-type fillings or illuminating compositions, the reaction should be very hot yet evolve little gas.

b. For munitions containing HC smoke fillings, the reaction should be hot and preferably produce some slag; some evolution of gas is acceptable.

c. For munitions containing colored smoke mixtures and toxic smoke mixtures, the reaction product may vary from gaseous slag to highly gaseous with no slag.

Ignition compositions which are used as rocket motor igniters are usually ignited by the output of a black powder which was commonly used for this purpose, has been replaced by igniter compositions composed of a powdered metal and inorganic oxidizer.

### 5-6.3 TYPICAL COMPOSITIONS

The compositions of typical igniter, first fire, and starter mixtures are given in Table 5-29.

## REFERENCES

1. *The Thermochemistry of Incendiaries*, NDRC Unnumbered, 2 Aug. 1943, Available at Technical Library, Edgewood Arsenal, as NDRC Misc. Pub. 308, Report of Division 11, National Defense Research Committee, Office of Scientific Research and Development, Washington, D. C.
2. A. T. Wilson, *Development of MOX Explosives: Various Oxidants in MOX*, NFOC-6, National Northern Corporation, West Hanover, Mass., December 1952.
3. R. W. Evans, *Experimental Investigation of Infrared Radiating Sources*, TN-9, Denver Research Institute, Denver, Colorado, July 1961 (DDC-AD 324 807).
4. S. Gordon, C. Campbell, "Differential Thermal Analysis of Inorganic Compounds," *Analytical Chemistry* 27, 1102 (1955).
5. A. M. Prentiss, *Chemicals in War*, McGraw-Hill Book Co., Inc., N. Y., 1937.
6. G. H. Custard, G. Francis, W. Schnackenberg, *Small Arms Incendiary Ammunition, A Review of the History and Development*, Frankford Arsenal Report R-1407-3, December 1956.
7. L. Finkelstein, A. E. Gaul, *Incendiaries, Vol. 18, Part II of History of Research and Development of the Chemical Warfare Service in World War II*, Edgewood Arsenal, Maryland.
8. S. J. Magram, *Starters, Vol. 16 of History of Research and Development of the Chemical Warfare Service in World War II*, Edgewood Arsenal, Maryland.
9. W. Jost, *Explosion and Combustion Processes in Gases*, McGraw-Hill Book Co., Inc., N. Y., 1946.
10. B. Lewis and G. Von Elbe, *Combustion Flames and Explosions of Gases*, 2nd Ed., Academic Press, Inc., N. Y., 1961.
11. H. F. Coward and G. W. Jones, *Limits of Flammability of Gases and Vapors*, Bulletin



**TABLE 5-29**  
**SOME FIRST FIRE, STARTER, AND IGNITER COMPOSITIONS**

<i>Composition (Percent by weight)</i>						
Aluminum						13
Boron			10			
Charcoal						4
Magnesium					25	
Silicon	20	25				26
Titanium		25				
Zirconium			20			
Zirconium Hydride	15					
Barium Chromate						
Barium Nitrate	50			90	75	
Iron Oxide ( $Fe_3O_4$ )		25				
Iron Oxide ( $Fe_2O_3$ )		25				
Iron Oxide (Scale)						22
Lead Oxide ( $PbO_2$ )			80			
Lead Oxide ( $Pb_3O_4$ )						35
Potassium Nitrate						
Tetranitracarbizole	5					
Laminac Binder	5*	**	**	**	**	**

\* Laminac binder: Laminac 99%; Lupersol 1%.

\*\* Most of these compositions can be used as a loose powder mixture or with binders such as celluloid, nitrocellulose or NC lacquer.

### REFERENCES (cont'd)

- 503, Bureau of Mines, Washington, D. C., 1952.
12. A. G. White, "Limits for the Propagation of Flame in Inflammable Limits," *Journal of the American Chemical Society* **127** (1925).
13. G. Von Elbe, B. Lewis, Papers presented at Third Symposium on Combustion and Flame and Explosion Phenomena, held at University of Wisconsin, Sept. 7-11, 1947, with Bureau of Mines, Pittsburgh, Pa.
14. G. W. Jones, *Research on Flammability Characteristics of Aircraft Fuels*, Progress Report No. 5, Bureau of Mines, Pittsburgh, Pa., March 1951.
15. *Science of Petroleum, IV*, Oxford University Press, 1938.
16. *Gunfire Tests to Determine the Vulnerability of Jet-propelled Aircraft Fuels*, Report F-27-1, Naval Proving Ground, Bureau of Naval Weapons, Washington, D. C., December 1945.
17. A. Stein, M. J. Torsch, *Effectiveness of Incendiary Ammunition Against Aircraft Fuel Tanks*, BRL Memorandum Report 484, Aberdeen Proving Ground, Md., 1948 (DDC-ATI 42 383).
18. A. J. Metzler, *Minimum Spark Ignition Energies of 12 Pure Fuels at Atmospheric and Reduced Pressure*, NACA-RME53H31, National Advisory Committee for Aeronautics, Washington, D. C., 1953.
19. G. W. Bauserman, *An Instrument for Determination of Transient Flame Temperatures*,

## REFERENCES (cont'd)

- Phase Report No. 4, Denver Research Institute, Denver, Colorado, 1952.
20. *Thermite, Plain, Incendiary*, CWS Formula No. D-1-1, 19 August 1944 (CWS Formulary, Technical Command, Edgewood Arsenal, 1 September 1945), Edgewood Arsenal, Maryland.
  21. *A Solidified Oil Incendiary, ETP-182-1*, Massachusetts Institute of Technology, Cambridge, Massachusetts.
  22. D. Hart, *Gasless Powders for Delay Elements of Fuzes*, Picatinny Arsenal Technical Report 1239, Picatinny Arsenal, Dover, N. J., 1943.
  23. S. Sage, *Manufacture of Barium Chromate Delay Powder on a Semi-Plant Scale*, Picatinny Arsenal Technical Report 1432, Picatinny Arsenal, Dover, N. J., 1944.
  24. D. Hart, *Delay Compositions*, Research and Development Lecture 27, Picatinny Arsenal, Dover, N. J., 1956.
  25. C. A. Poppendieck, *Research on Heat-Producing Compositions*, First Quarterly Report, Contract DA-36-039-SC-75071, Catalyst Research Corporation, Baltimore, Md., 1958.
  26. L. Apostolos, *Powder Plate Development*, Catalyst Research Corporation, Baltimore, Md., 1953.
  27. *Apparatus for Testing Pulp and Paper*, Bulletin VII, Williams Apparatus Company, Wauertown, N. Y.
  28. R. H. Comyn, *Pyrotechnic Research at DOFL. Part I. Heat Source Materials*, Technical Report 884, Harry Diamond Laboratories, Washington, D. C., 1960 (DDC-AD 321 045).
  29. AMCP 706-210, Engineering Design Handbook, *Fuzes, General and Mechanical*.
  30. R. H. Comyn, *The Use of Gasless Mixtures for Producing Controlled Time Delays in Ordnance Devices*, DOFL Report 22-576, Harry Diamond Laboratories, Washington, D. C., 1957.
  31. *Ordnance Explosive Train Designers Handbook*, R-1111, Naval Ordnance Laboratory, Bureau of Naval Weapons, Washington, D. C., 1952.
  32. AMCP 706-179, Engineering Design Handbook, *Explosive Trains*.
  33. B. Werbel, S. Lopatin, *Development of Delay Powders*, Picatinny Arsenal Technical Report 2477, Picatinny Arsenal, Dover, N. J., 1958.
  34. M. F. Murphy, *A Comparative Study of Five Pyrotechnic Delay Compositions*, NAVORD-5671, Naval Ordnance Laboratory, Bureau of Naval Weapons, Washington, D. C., 1958.
  35. M. F. Murphy, *Current Topics in Gasless Heat Powder Work at NOL*, Speech before NOL Pyrotechnic Symposium, Naval Ordnance Laboratory, Bureau of Naval Weapons, Washington, D. C., 1959.
  36. R. H. Comyn, *Pyrotechnic Research at DOFL. Part II. Pyrotechnic Delays*, TR-1015, Harry Diamond Laboratories, Washington, D. C.
  37. P. Rochlin, *Mass Spectrometric Analysis of Gaseous Combustion Products from Delay Powders*, Picatinny Arsenal Technical Report 2006, Picatinny Arsenal, Dover, N. J., 1954.
  38. R. A. W. Hill, T. L. Cottrell, "Studies of Combustion Waves in Solids," *Fourth Symposium (International) on Combustion*, The Williams and Wilkins Company, Baltimore, Md., 1963.
  39. J. E. Spice, L. A. K. Staveley, "The Propagation of Exothermic Reactions in Solid Systems, Part I. Preignition Reactions. Part II. Heats of Reaction and Rates of Burning," *Journal of the Society of Chemical Industry* 68, 313-19, 348-55 (1949).
  40. S. Nakahara, "Studies on Delay Powders, I. Measurement of Temperature of Combustion of Delay Powders," *Industrial Explosives Society Journal*, 1958.
  41. S. Nakahara, T. Hikita, "Studies on Delay Powders, 11. The Combustion Pressure of Delay Powders," *Industrial Explosives Society Journal*, 1958.
  42. S. Nakahara, T. Hikita, "Studies on Delay Powders, 111. On Mechanism of Delay Powders," *Industrial Explosives Society Journal*, 1958.
  43. S. Nakahara, "Studies on Delay Powders, IV. Theory of Combustion Propagation Velocity of Delay Powders," *Industrial Explosives Society Journal*, 1958.
  44. S. Gordon, E. D. Crane, *Compilation and*

## REFERENCES (cont'd)

- Evaluation of the Ignition Temperature Parameters and Differential Thermal Analysis for Pyrotechnic Systems. I. Barium Chromate-Boron*, Picatinny Arsenal Technical Note 24, Picatinny Arsenal, Dover, N. J.
45. R. Comyn, R. Skelton, *Effect of Pressure on the Burning Rate of Gasless Delays*, NAVORD-1787, Naval Ordnance Laboratory, Bureau of Naval Weapons, Washington, D. C.
  46. M. Gilford, B. Werbel, G. Weingarten, L. Key, *The Anticipating Effect. A Study of the Burning Mechanism of Delay-Relay Columns*, Picatinny Arsenal Technical Report 3047, Picatinny Arsenal, Dover, N. J., 1964.
  47. R. E. McIntyre, *Factors Affecting the Blending of Gasless Mixtures*, TP-648, Harry Diamond Laboratories, Washington, D. C., 1959.
  48. B. Werbel, *Recent Advances in Pyrotechnic Delay Compositions*, Speech presented at White Sands Proving Ground, November 17, 1959, Picatinny Arsenal, Dover, N. J.
  49. *The Application of Lead Tubing to the Filling of Pyrotechnic Delays*, Branch Memo X4/3/58, Armament Research and Development Establishment, Ministry of Supply, Great Britain.
  50. H. Ellern, *Modern Pyrotechnics*, Chemical Publishing Co., 1961.
  51. K. L. Davis, *Chemistry of Powder and Explosives*, John Wiley & Sons, N. Y., 1943.
  52. R. C. Maninger, *Background of Exploding Bridgewire and Conventional Systems*, Presented at American Ordnance Association Joint Technical Meeting on Exploding Bridgewire Systems, Los Angeles, California, February 10-11, 1964.
  53. S. J. Magram, *A Survey of Starters for Burning Type Munitions*, TDMR-655, Edgewood Arsenal, Maryland.

## CHAPTER 6

## PRODUCTION OF LIGHT

## 6-1 HISTORICAL SUMMARY

Military pyrotechnic items used for illumination and signaling by the military share a common origin with the spectacular white and colored flames produced by fireworks. Tracing the development of these compositions is relatively easy since there was little progress made in the development of flame producing compositions until the introduction of potassium chlorate pyrotechnic mixtures near the end of the 18th century.<sup>1</sup>

## 6-1.1 CONSOLIDATED ILLUMINANTS

## 6-1.1.1 Flares and Signals

Modern fireworks, with a few exceptions, can be divided into two types, those designed to produce force and sparks, and those producing a flame.<sup>1,2</sup> Early efforts were directed toward the development of spark and force producing compositions. At that time, there was no known way of imparting color to a flame. As a result, there was little difference to the eye between a flame produced by a pyrotechnic mixture and one resulting from the burning of pitch, petroleum, or resinous wood. Sparks could be varied in form and brightness, although not in color, so that spark compositions became, and remained for centuries, the main consideration of the fireworks maker.

The few flame compositions available in the 17th century usually included a flammable liquid in order to ensure combustion of the rest of the mixture consisting of gunpowder, antimony sulfide, and arsenic sulfide. Appier<sup>1,2</sup> was far in advance of his time when he suggested the use of acetate of copper to give a green tint to a flame. By the early part of the 19th century, a pyrotechnist, Claude-Fortune Ruggieri,<sup>3,4,5</sup> suggested the use of metal salts and ammonium chloride in the production of a colored flame.

The modern era in pyrotechnics began with the introduction of potassium chlorate which was first

prepared in 1786 and first mentioned as an ingredient in a pyrotechnic composition in 1823.<sup>6</sup> By 1830 several formulas containing potassium chlorate had been developed for firework display, military signaling and signaling at sea. While most colors could be produced in a more or less satisfactory manner by 1850, it was several years later before a satisfactory blue flame was produced. This was accomplished by adding copper salts to compositions containing potassium chlorate. The color was enriched by the use of calomel,  $Hg_2Cl_2$ . During this period colored flames produced by adding color-emitting salts to potassium chlorate and sulfur compositions were found to be very satisfactory. In spite of their good color quality, these compositions were abandoned because of their sensitivity to impact and friction. Sulfur was replaced first by powdered shellac and later by other gums and resins.

Magnesium was first produced on a commercial scale in 1860 and was used by European pyrotechnicians several years later. In the United States, possibly because of its cost, magnesium was not used in military pyrotechnic mixtures until around 1926. Aluminum was not used appreciably in pyrotechnic compositions until near the end of the 19th century when it became commercially available.

Illuminating compositions for military applications were, basically, the same as those used in firework displays over two hundred years earlier. A primitive type of light producing item—whose composition consisted of saltpeter, sulfur, resin, and linseed oil—was included in British military stores until at least 1870. Most important of the few inventions in military pyrotechnics during the latter part of the 19th century was the parachute light which appears to have originated about 1820 in Denmark much in advance of its widespread use in the World Wars of the 20th century. Another invention, the Very Pistol which was patented in 1878, originated as a civil signaling device. Ini-

tially, the pistol had a one-inch bore; this was later increased to one and one-half inches during World War I. Improved illuminating and signaling devices were developed in the 1914-1918 period because they were required in the trench warfare of World War I to a much greater extent than in prior wars. The growing importance of air warfare opened a whole new field for the use of illuminants and signals. Simulators and decoys were developed for the purpose of misleading enemy observers.

Most of the illuminating and signaling devices produced in the period between World Wars were developed by empirical methods. The limited amount of work performed in this period necessitated a hurried attempt to put the pyrotechnic field on a scientific basis at the start of World War II. This attempt was hampered by the necessity of producing items for immediate use on the battlefield. Most of the research and development continued to rely upon empiricism. However, a limited amount of basic and applied research, much of it directed toward the development of better light producing compositions, was started at several of the Government installations and continued after the war. Results of the work done after the war were extremely rewarding. At the end of World War II some opinion was expressed that little improvement could be made in flare and photoflash compositions.<sup>7</sup> Contrary to this opinion, major improvements were made, some of them in time to be of great service in the Korean Conflict.<sup>8</sup>

Current research and development effort is being directed toward the development of advanced flare compositions, for both illuminating and signaling purposes, to function at altitudes where little or no atmospheric oxygen is available.

### 61.1.2 Tracers

Before the invention of gunpowder and the use of bullets, there was no need for tracers. The projectiles used, namely spears and arrows, were large in size, and traveled at a low velocity, so that their line of flight could be readily followed. Arrows tipped with burning grass might be considered the first tracers. Though the prime reason for using these burning arrows was to start fires, the course of the arrow could be followed at night.

The range of the crude guns introduced after the invention of gunpowder was so short that the point of impact of the projectile could be noted by the eye. However, this was no longer possible after the introduction of weapons which fired small-caliber, high-velocity bullets over ranges of more than a thousand yards. During World War I, the need for tracers was intensified by the wide use of machine guns. The need for tracers became acute, coincident with the enormous expenditure of ammunition by infantry and air service. At long range, in the air and on the ground, it was almost impossible to estimate range and correct aim by observing the point of impact of bullets which did not incorporate tracers.

During World War I, the air services of both the Allied and Central Powers urgently demanded an efficient, accurate tracer bullet and, as the result, tracer ammunition was soon developed by all of the belligerents. A German tracer composition—containing a mixture of magnesium, strontium nitrate, calcium hydroxide and rosin—was not very satisfactory because it was difficult to ignite and produced a very dim and indistinct trace. The French tried several tracer mixtures which contained a small amount of linseed oil as a binder. These tracers were quite brilliant and dependable but were unstable in storage and became practically useless soon after manufacture. As a result, French tracers were made immediately behind the lines so that the ammunition could be placed in the hands of the troops as promptly as possible. If the ammunition could not be used within two or three weeks, it was scrapped and replaced.

After the United States entered the War, a program of developing better tracer ammunition for the American Expeditionary Forces was activated. The result of this work was the development of M1917 tracer ammunition, which consisted of a jacket of cupronickel surrounding a container of gilding metal and a lead shot. The tracer composition was a mixture of barium peroxide and magnesium in grain alcohol, which was dried and pressed into the container at 48,000 pounds per square inch. This tracer was quite satisfactory and produced a trace—which was not especially brilliant—for about 500 yards. Another tracer

was developed in cooperation with the British, using a mixture of barium nitrate, barium peroxide, and magnesium loaded in a hollow brass bullet. An igniter mix of barium peroxide and magnesium was required with this tracer mixture.

The using services were not satisfied with the status of tracer ammunition at the end of the War, and again studies directed toward the production of a better tracer bullet were resumed. Many mixtures were tried during this period and it was found that calomel would increase the brilliance and luminosity of the trace produced; this resulted in the introduction of the M1923 tracer bullet, caliber .30, and the design of an M1924 prototype. During this period, tracers were developed for caliber .50 and also for caliber .45 weapons; these were used primarily as red, green, and white signal rounds. It is also interesting to note that the M1923 tracer was evaluated as a small arms incendiary bullet and found to be superior to the then-available small arms incendiary ammunition; for some time thereafter this tracer also served as a small arms incendiary. By December 1926, military requirements brought about standardization of the red tracer as the only one approved for general military use. The designation was "Bullet, Tracer, Caliber .30, M1." The tracer composition contained strontium peroxide made by the dry process and a higher-density calomel.

The igniter composition contained barium peroxide and fine magnesium. Tracer M1 was also loaded with a subigniter consisting of three parts igniter and one part tracer composition to insure ignition of the tracer composition. These changes resulted in an increased length of trace to 1300 yards for caliber .30 tracers, and to 2200 yards for caliber .50 tracers. Research and development concerned with small arms ammunition continued at a very limited rate resulting in changes such as the development of a gilding metal bullet jacket to replace the cupronickel jacket. The bullet design of the caliber .30 M1 tracer was standardized in 1929, based upon the M1924 prototype round; however, the pyrotechnic compositions were changed significantly during the period between World War I and 1929. For example, many strontium compounds such as strontium peroxide, strontium oxalate, and strontium nitrate were in-

vestigated as a means of improving color of the flame and burning. During this period, calcium resinate was introduced as an improved composition binder. By 1929, there was concern as to the effects of incorporating mercury compounds such as calomel in tracer bullets because, under certain conditions, it was observed that the jackets split in storage, probably due to the liberation of the mercury from the calomel. Investigation proved that the cracking of the jacket was due to the presence of free mercury, and elimination of tracer compositions followed.

In addition to this work, a limited amount of research and development effort directed toward the development of red tracer compositions for ammunition larger than caliber .50 was initiated. During this same period, the Navy had developed and adopted satisfactory compositions for red, white, green, and orange tracers.

About 1934, study of test records showed that Army tracers became unsatisfactory after five years' storage. The tracer composition had been wet-processed to obtain good storage stability; i.e., the calcium resinate was dissolved in carbon tetrachloride, mixed to a paste with the other ingredients, baked dry, and pulverized to a powder to render all ingredients moisture-repellent. Poor storage stability was apparently due, not to the tracer composition, but rather to the dry-blended barium peroxide-magnesium-red lead igniter composition. Red lead, although aiding bonding and identification of the igniter composition, was found to be chemically incompatible with barium peroxide and, therefore, was removed from the formula. The magnesium was pre-treated with water to form a protective oxide coating and one percent zinc stearate was added as a water repellent. This igniter blend proved to be more stable under high-humidity testing and was adopted for use in 1937.

During the period from 1935 to 1941, development work on delay action and dim igniters for small arms tracers was active.<sup>9,10</sup> Two compositions were developed which were standardized. These compositions form the basis for all delay action and dim igniters used in small arms ammunition. The basic composition is designated I-136 Delay Action and is composed of 90 percent strontium peroxide and 10 percent calcium resi-

nate. Dim initial trace is controlled by the quantity of magnesium added to 1-136 composition. Standard I-194 Dim Igniter contains 6 percent magnesium. Compositions incorporating "delay action" function so as to produce no visible trace up to some prescribed distance along the trajectory; then the tracer composition is ignited. This action is desirable to avoid revealing gun positions. Dim ignition provides a dim trace and has the advantage of providing fire control directly from the gun muzzle for some prescribed distance, at which distance the bright tracer composition is ignited. This type of ignition is particularly desirable for firing at planes and other fast-moving objects at night since the dark-adapted eyes of the gunner would be seriously affected by the standard, bright igniter composition used for daylight conditions. To insure proper functioning and storage stability of delay and dim igniters, it was necessary to develop a high assay, wet-processed (or precipitated) strontium peroxide. Unconverted strontium hydroxide (always present in this compound) had to be reacted with the free abietic acid of the calcium resinate which had previously been dissolved in carbon tetrachloride. This wet-processing technique provided a composition more sensitive to ignition and less affected by moisture.

During the 1935-1941 period, the Navy again became interested in the development of dim and dark types of tracers for use with the 40 mm gun because of the self-destruct requirements for its ammunition.

Immediately prior to and during World War II, demands were suddenly made on U.S. industry to supply huge quantities of pyrotechnic chemicals which had previously been supplied in very limited quantities by only a few manufacturers. These demands resulted in large production of such chemicals as the alkaline earth peroxides, perchlorates, nitrates, and magnesium powder by establishments with relatively little experience in their manufacture. Because of the urgency of maintaining peak production schedules, specifications defining the quality of raw materials were often waived to the detriment of overall ammunition function and stability during storage. A notable example was magnesium powder, which had been produced during peacetime as clean, bright

metal particles of 98 percent metal content. During the war, magnesium powder was used which ranged from dark gray to almost black with a metal content as low as 80 percent.

Another example was the immediate change from wet-processing of tracer compositions to dry-processing, or simple blending of the dry ingredients. This was a faster and less hazardous method but it produced compositions that were more difficult to load, less uniform in ignition and burning, and more susceptible to attack by moisture. For several years the technical effort expended in both the Government and industry—when conducting chemical, engineering, and functional tests—had the purpose of assuring a continuous supply of ammunition which was intended for almost immediate expenditure by the troops. As the war proceeded, it became apparent that much of this war production would not be used immediately and would probably remain for relatively long periods in storage depots.

A review of the overall situation aimed at improving quality of pyrotechnic ammunition was then initiated, and research programs for this purpose resulted. In addition, the continuous development of many new types of tracer ammunition continued. These developments included colored smoke tracers, tracers for caliber .30 M1; caliber .30 carbine; caliber .45; caliber .50; caliber .60; 20 mm; and the larger artillery rounds (most of which included the combination types, i.e., armor-piercing tracer, and armor-piercing incendiary tracer).

The surge of effort for improved tracer pyrotechnics, begun during World War II, included research and development programs to investigate higher purity chemicals, effect of chemical impurities on functioning and stability, critical moisture content permissible for long term storage, development of metal and plastic types of base closure seals to prevent moisture entry, and water pre-oxidation and dichromate treatment of magnesium powder for improved stability. In addition, many new kinds of materials were developed for use in pyrotechnic compositions. These include new grades of alkaline-earth peroxides, atomized (consisting of spherical particles) magnesium,

magnesium-aluminum alloys, and titanium and boron powders.

More basic studies have included investigations of threshold visibility and its relationship to background, distance, candlepower, and color Values; the relationship between impact sensitivity of the composition and reliability of tracer ignition, and the effect of cavity geometry and high speed bullet rotation on the candlepower and burning time; and particle-size measurement and the effect of particle size on burning characteristics. Recent studies have been concerned with the determination of the reaction kinetics of pyrotechnic compositions by such methods as differential thermal analysis and differential gravimetric analysis. Use of pyrotechnics at very high altitudes presents new problems. These problems have resulted in studies of the mechanisms of reaction at low pressure and/or in the absence of an oxygen atmosphere and the development of pyrotechnic compositions designed from the data thus obtained.

## 6-1.2 NONCONSOLIDATED ILLUMINANTS

Nonconsolidated illuminants are comprised mainly of various types of photoflash devices including photoflash bombs and cartridges, and spotting devices. They consist of loose-loaded pyrotechnic compositions which react rapidly to produce a brilliant flash of light, when confined, similar to that produced by the common photoflash bulb.

### 6-1.2.1 Photoflash Devices

The use of photoflash powder to provide artificial illumination for photographic purposes was fairly common long before the military use of aircraft for reconnaissance purposes. Toward the end of World War I, when the importance of aerial photographic reconnaissance during the day had been widely recognized, the military advantages of night aerial photography also became apparent and attempts to provide devices for this purpose were made by both Allied and Central Powers.

#### 6-1.2.1.1 Photoflash Bombs

##### 6-1.2.1.1.1 Composition Type

The study of artificial light sources for night aerial photography was continued in the United

States after World War I, when commercial flashlight powder was exploded in 25-, 60- and 100-pound containers with only partially satisfactory results. In 1925, the Air Corps tested commercial photoflash powder, carried in towed gliders, as a light source. About this time, attempts to produce a suitable photoflash powder followed two general lines of investigation. The first was to develop a fast burning flashlight composition and the second involved the development of illuminating materials which could be detonated. Essentially, all photoflash mixtures used during the period through World War II were of the first type. Development of an illuminating mixture which could be detonated was not completed until after World War II.

The hazardous and unsatisfactory system using the towed glider, which limited a mission to one photograph, was abandoned in favor of a parachute-suspended cylindrical bomb. While other shapes were tried later, this shape, in general, proved to be most efficient. An important requirement was for a flash powder that would produce peak light output during the time the camera shutter was open. This resulted in the development, by 1930, of a photoflash mixture consisting of 34 percent magnesium, 26 percent aluminum, and 40 percent potassium perchlorate. This was established as the Standard Type I photoflash powder.

In the early part of the 1930's, two photoflash bomb designs were in use: one, a rectangular plywood box designed to be carried on external racks; the other, a paper tube seven inches in diameter and 32 inches long, which contained about 25 pounds of flash powder. This latter type became the first standard photoflash bomb and was later known as the T1 or M12 Photoflash Bomb.<sup>11</sup> It was carried within the fuselage of the airplane; used a parachute to retard its drop; and was satisfactory for use with aircraft operating at 200 miles per hour at altitudes up to 5000 feet. The final modification of this bomb produced a peak intensity of 325 million candlepower and an average total radiation of 22 million candlepower-seconds. The M12 Photoflash Bomb was used for training purposes only.

The M23 Photoflash Bomb<sup>12</sup> was developed in



order to increase the number of photographs obtainable on a mission. It contained about seven pounds of flash powder in a cylindrical paper-board case. Later it was placed in a streamlined steel outer case to improve its operational characteristics. Development of the M46 Photoflash Bomb was started just before the United States entered World War II. This bomb contained up to 25 pounds of photoflash mixture in a streamlined metal case and was widely used in World War II for photography from intermediate altitudes.

In an attempt to increase the intensity of the light from pyrotechnics, scientists under National Defense Research Committee auspices at Wesleyan University and at the California Institute of Technology conducted a more fundamental study of photoflash powder. Both groups reached the conclusion that no real improvement in flash output could be gained by changing the standard magnesium-aluminum-potassium perchlorate mixture then in use. Consideration was then given to possible methods of obtaining a more efficient distribution of the light from the flash. Further study, however, indicated that a larger bomb was an easier way to obtain higher levels of illumination. Because of shortages of aluminum and magnesium powders at the start of World War II, a mixture using a magnesium-aluminum alloy as a fuel instead of a mixture of magnesium and aluminum, known as Type 11, Class A, photoflash powder was developed. Later, barium nitrate was adopted as the oxidizer. This mixture was known as Type II, Class B, photoflash powder. Later, a new standard photoflash powder, Type III, Class A, consisting of 40 percent aluminum, 30 percent barium nitrate, and 30 percent potassium perchlorate was adopted.<sup>13</sup> It was found that the latter mixture, when confined in a heavy-walled casing, would produce more light output from a smaller and safer photoflash bomb. These results led to the cancellation of further work on thin-walled photoflash bombs for high altitude, night aerial photography, and led to the development of the safer heavy-walled bombs. These bombs were in production in late 1951 and were used in the Korean Conflict in 1952. While much safer than the M46, this type of bomb still did not meet

the requirement that it should be no more sensitive to projectile fragments and bullet impact than a general purpose bomb.

Work on photoflash compositions continued with considerable emphasis directed toward the development of flash mixtures containing calcium, which were more effective at higher altitudes than other photoflash mixtures.

#### 6-1.2.1.1.2 Dust Type<sup>14</sup>

The need for night illuminant safer than the standard flash powder bomb (which was easily detonated by bullet impact) led to a requirement for a less-sensitive powder composition. This approach was considered to be preferable to armor-ing the bomb. By 1943, British reports of the development of a safe metal dust bomb, using either aluminum or magnesium powder detonated by a tetryl burster, had been received. Initial tests made in this country of the metal dust type were not encouraging. It was found that the "safe" powder produced only about 20 percent as much light as the standard photoflash bomb. Further work resulted in the T8 bomb, which was a complete failure. Instead of dispersing as a dust to explode in a short bright flash, the milled magnesium powder used in the bomb apparently compacted into large adhering masses which burned progressively.

The T8E1 bomb, containing 70 pounds of flake aluminum and weighing over 200 pounds, reached a peak intensity of one billion candlepower in about 12 milliseconds. This was little more than the peak candlepower of the 50-pound M46 bomb. A ring-shaped flash with a characteristic non-luminous core was produced, presumably caused by gaseous decomposition of the high explosive burster. The same dark center was also noted in the British dust bombs, Mark III and Mark IV. By the end of the War, small scale tests of a variety of metal dusts, bursters, and casings showed that a conical burster eliminated the dark core.

Continuing research on metal dust bombs showed that a satisfactory bomb was unattainable with magnesium dust. The smaller the burster, in proportion to weight of dust, the greater the efficiency in terms of candlepower-seconds per gram, but the slower the flash. No satisfactory point of

compromise could be found. The use of atomized magnesium-aluminum alloy was then suggested because of its nonhygroscopic nature. It provided twice the peak candlepower of magnesium dust accompanied by relatively little change in total light output.

A separate development project was started in 1948 and led to the standardization of the M122 dust bomb in 1952.<sup>15</sup> The M122 was eight inches in diameter by 54 inches in length, with a total weight of 110 pounds. The bomb achieved a peak of 0.82 billion candlepower, although the average of several tests was about 0.70, and in the best 40 millisecond period it produced 31.9 million candlepower-seconds. It was slow to peak, requiring about 42 milliseconds. The flash was so long in duration that on one occasion two photographs were taken with a single camera using the light of a single bomb. Under ideal conditions of clear atmosphere and high reflectance terrain, it was possible to obtain usable photographs at altitudes of 16,000 to 20,000 feet. Good photos under normal conditions were possible at altitudes of 5000 to 12,000 feet. The bomb was stable from an airspeed of 185 to 400 miles per hour. The RB-26 aircraft carried a load of ten M122 bombs; the RB-45C carried twenty-five; and the RB-50 carried fifty-two. Procurement was initiated too late for use in the Korean action.

#### 6-1.2.1.1.3 Segregated Oxidant Type

In 1950, the development of a segregated oxidant type photoflash bomb was begun in an attempt to obtain both the safety from impact initiation associated with the dust type bomb and the high peak light intensity associated with the photoflash powder type bomb. In addition, this type bomb—in which the burster, oxidant, and metal dust are loaded separately in coaxial cylinders—also should be relatively insensitive to altitude as compared to the dust which depend entirely on atmospheric oxygen. Considerable effort was directed toward the development of a bomb of this type; however, the results obtained did not prove to be markedly superior to those obtained with the newer nonsegregated types. As a result, the segregated oxidant photoflash bomb was not developed into a standardized item.

#### 6-1.1.2.2 Photoflash Cartridges<sup>16</sup>

While most of the night aerial photographs during the early phases of World War II were obtained at relatively high altitudes, the need for low level night aerial photographs during the latter phases of the war *was* anticipated. Therefore, development of suitable photoflash mixtures, as well as cartridges and ejectors for this purpose, was started but the work progressed slowly because of low priority.

In 1943 when the need became acute, the United States' designs were not complete and a photoflash cartridge designed and developed by the British was used. This cartridge was based on the case used for the Very parachute flare. By 1945, the first low altitude photoflash cartridge developed in the United States was based on a standard signal flare case and contained about five ounces of Type 11, Class B flash powder. Its light output characteristics were poor and, hence, it was not standardized or used during World War II.

The first United States standardized photoflash cartridge was developed by 1949. It contained the then new Type III photoflash powder and could be used to obtain satisfactory aerial photographs up to an altitude of 4000 feet. These cartridges were used extensively in the Korean Conflict for low altitude night reconnaissance photography. As the tactical situation in Korea often required night photographs at higher altitudes, the M46 bomb was also widely used. However, due to the greater weight of the M46 bomb, fewer units could be carried, resulting in a demand for smaller units having adequate candlepower. This requirement had been anticipated and tests using the Type 111, 30/40/30 formula (potassium perchlorate 30%, aluminum 40%, and barium nitrate 30%) had been made as early as 1947, using charges ranging in size from 1.7 to 7 pounds. The 1.7-pound charge was found to be entirely adequate up to 8000 feet and was loaded as the M123 cartridge with an obturated delay fuze of two, four, or six seconds. Work on photoflash cartridges continued after the Korean Conflict.

In 1951 an attempt was made to obtain an increased light output together with safe characteristics for use in photoflash cartridges. A high

metal content mixture (70 percent aluminum and 30 percent potassium perchlorate) was used with massive bursters of RDX. This mixture gave twice the total light of the Type III 30/40/30 formula and was relatively insensitive to both friction and flame initiation. Since that time, a limited amount of work has been continued on photoflash cartridges and associated high rate ejection systems for night aerial photography and other purposes.

### 6-1.2.2 Spotting Charges

For many years, the flash and smoke produced by the functioning of a small explosive charge, usually black powder, was used as an aid in spotting the point of impact of practice ammunition. Occasionally, these charges were also used in connection with certain items of service ammunition.

During and after World War **11**, the development of large caliber weapons for use in tanks created a need for simple and reliable target acquisition for these weapons. One of the more satisfactory systems developed employed a subcaliber spotting rifle aligned with the major weapon. This rifle fired a projectile having a trajectory closely matching, in the critical range, that of the major weapon so the location of the flash and smoke produced by the pyrotechnic charge in the subcaliber round indicated where the major round would hit.

High precision tracking data is necessary in the development of intermediate- and long-range missile systems. To obtain this data, brilliant light flashes must be produced of sufficient intensity to be recorded by a tracking camera and also be of a short enough duration to provide accurate position information. Early sources of light used for this purpose were of the gas discharge type. To obtain sufficient light intensity without the weight penalty associated with electronic flash systems, pyrotechnic light sources were developed for this purpose. While the first pyrotechnic system developed, the Daisy Photoflash Cartridge, was a satisfactory light source for a tracking aid, it created other problems, the most serious of which was the production of metal fragments and attenuation of radio signals, which resulted from the functioning of the flash signal.

In addition to minimizing these problems, further development resulted in a series of flash

signals of differing intensities which allowed more flexibility in programming of flashes along the trajectory of the missile. Flash signals also have been developed to evaluate the functioning of the missile warhead frequency system.

Further information and references on non-consolidated illuminants may be found in comprehensive reports available.<sup>17,18,19</sup>

## 6-2 THEORY OF LIGHT AND COLOR

### 6-2.1 BEHAVIOR OF LIGHT

In a strict physical sense, light is that electromagnetic radiation which affects the eye and produces vision. The wavelength range of visible radiation extends from approximately 3800Å to 7000Å; the angstrom unit, Å, is equal to 10<sup>-8</sup> centimeters. Other units used for indicating the wavelength of electromagnetic radiation include the micron, μ, which is equal to 10<sup>4</sup> angstrom units. In a less strict sense, the term light is also applied to electromagnetic radiation whose wavelengths are longer (infrared) or shorter (ultraviolet) than those for visible light.

All forms of electromagnetic radiation, including light, are absorbed and emitted as integral numbers of energy quanta and are transmitted by particles known as photons. The amount of energy,  $E$ , associated with each photon is:

$$E = h\nu \quad (6-1)$$

where  $\nu$  is the frequency of the radiation, and  $h$  is Planck's constant. This equation is often expressed in other ways, such as:

$$E = \frac{hc}{\lambda} = hc\bar{\nu} \quad (6-2)$$

where  $c$  is the velocity of light in centimeters per second;  $\lambda$  is the wavelength in centimeters;  $\bar{\nu}$  is the wave number, the reciprocal of the wavelength in centimeters; and  $h$  is Planck's constant.

All electromagnetic radiations, including light, have both particle and wave properties. This dualistic nature is also applicable to matter. According to the deBroglie equation, the wavelength associated with a particle of mass  $m$  moving at a velocity  $v$  is given by:

$$\lambda = \frac{h}{mv} \quad (6-3)$$

Many of the effects of light may be simply explained by assuming that light, in a uniform medium, will travel in straight lines at measurable velocity. This assumption, which is the basis for geometric optics, is very nearly true in most cases of interest in pyrotechnics. The direction, or path of light, is often represented by a straight line called a ray. Other effects, which cannot be explained by geometric optics, must be discussed in terms of the wave nature of light, while still others must be explained in terms of the particular nature of light.

A knowledge of the properties of light is important in pyrotechnics due to the need for measurements and instrumentation required for evaluation, and to carry out the necessary research aimed at improving light and color sources. Some of these properties include reflection, transmission, absorption, refraction, and the optical characteristics associated with mirrors and lenses. These subjects will not be discussed in detail as standard physics texts cover them and may be consulted when required.<sup>20</sup> One of the most important characteristics associated with the electromagnetic spectrum of radiation is spectral distribution; analysis of this distribution provides an excellent tool for determining the emitting species in flames and other light sources. For this reason, several of the subsequent paragraphs are devoted to this area.

## 6-2.2 SPECTRAL DISTRIBUTION

If a narrow beam of white light is passed through a prism, each wavelength is deviated in direction by a different amount and the light beam is spread out into an array of colors. The array of colors is called the visible spectrum, and extends from about 0.4-micron to about 0.7-micron. This visible portion of the spectrum represents a very small fraction of the electromagnetic radiation commonly emitted by radiation sources, and lies between the longer wavelength (infrared) and the shorter wavelength (ultraviolet) portions of the electromagnetic radiation spectrum to which the eye is insensitive.

Spectra of two general types are observed, emission spectra and absorption spectra. Emission spectra are produced by light which is emitted from luminous and incandescent bodies and con-

sist, in the optical region, of colored lines, colored bands, and colored regions on a dark background. Absorption spectra are produced by white light which has been passed through gases, liquids, or other light-absorbing materials on a brightly colored background. Both types of spectra can be observed in wavelength regions outside the visible by special techniques.

Depending on the appearance of the spectra produced in a given wavelength interval, both emission and absorption spectra can be further classified as discrete or continuous spectra. The spectral distribution of the light produced by pyrotechnic light sources for both illumination and signaling is important; therefore emphasis in the following paragraphs will be on emission spectra.

### 6-2.2.1 Discrete Spectra

Luminous gases and vapors under moderate or low pressures yield emission spectra which consist of definitely placed bright lines or closely placed groups of bright lines called bands. The energy,  $E$ , associated with a quantum of light having the same frequency,  $\nu$ —i.e., a spectral line—is:

$$E = h\nu = E_2 - E_1 \quad (6-4)$$

where  $h$  is Planck's constant. This energy is the difference between two quantized energy levels in the atom or molecule, designated above as  $E_1$  and  $E_2$ , so that, the wavelengths of the spectral lines are characteristic of the radiating source. The number of lines and their relative intensities in an emission spectra also depend on the method of excitation.

A line observed in an emission spectrum results from the transition of the atom or molecule from a higher,  $E_2$ , to lower,  $E_1$ , energy level;<sup>21</sup> i.e., the transfer of quanta of energy is evolved. If the line is observed in an absorption spectrum, the atom or molecule is raised from a lower to higher quantized energy level by the absorption of a light quantum of the proper frequency.

#### 6-2.2.1.1 Line Spectra<sup>22</sup>

Line spectra—consisting of a series of sharp, brightly colored lines on a dark background—are produced by single or chemically uncombined

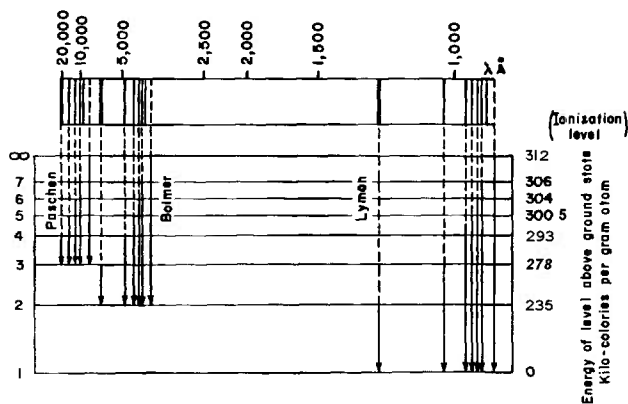

Figure 6-7. Emission Spectrum and Energy Levels of Hydrogen Atom

atoms and, therefore, are often called atomic spectra to distinguish them from the band spectra characteristic of molecules (Paragraph 6-2.2.1.2). The complexity of the line spectra produced by emission depends on the particular atom involved and the method of excitation. Normally, more lines appear in a spark spectrum than in an arc spectrum and both exhibit more lines than a spectrum produced by thermal excitation in a flame.

The term "line spectra" can also be considered a collective term including both atomic and ionic spectra. In this context, atomic spectra are produced only by neutral atoms while ionic spectra refers to spectra produced by ionized atoms. Less energy is required to excite an atomic line than is required to ionize an atom and excite an ionic line. In general, therefore, only atomic lines are found in the spectra excited by arcs and flames. Lines due to ionized atoms are found in spark-excited spectra where excitation is due to high velocity electrons and the energy is sufficient to excite spectra corresponding to large differences in energy.

Because the energy levels in an atom are related to the configuration of the extra-nuclear electrons, the simplest line spectra are produced by atomic hydrogen (note that the spectra for ionized helium will be similar) where the observed spectra (Figure 6-1) can be represented by:

$$\bar{\nu} = R \left( \frac{1}{k_1^2} - \frac{1}{k_2^2} \right) \quad (6-5)$$

where  $\bar{\nu}$  is the wave number, the reciprocal of the wavelength in centimeters;  $R$  is the Rydberg

constant; and  $k_1$  and  $k_2$  are integers. The Lyman series found in the ultraviolet, and for which  $k_1 = 1$  and  $k_2 = 2, 3, 4, \dots$ , is caused by transitions from excited atomic states to the ground state or lowest atomic energy state, as is also illustrated in Figure 6-1. The Balmer series found in the visible spectra for which  $k_1 = 2$  and  $k_2 = 3, 4, 5, \dots$ , is caused by transitions from excited atomic states to the first excited state. Other series—including the Paschen series, Brackett series, and Pfund series—are found in the infrared. The spectral lines for materials of higher atomic number rapidly become so complex that they cannot be represented by a single simple equation.

### 6-22.12 Band Spectra<sup>23</sup>

The emission spectra in the visible or ultraviolet region, due to molecules, consist of a relatively large number of regularly arranged, but complicated, groups of lines called bands. These line sequences are called bands because they appear as structureless bands in low dispersion spectrographs. Each band spectrum shows, in general, a threefold structure. It consists of a number of similar but separated groups of bands making up the band systems. Each band system is made up of a number of bands, sometimes arranged in sequence, consisting of a number of regularly arranged lines.

This threefold structure is due to the partitioning of the total internal energy of the molecule into three parts resulting from: the electron configuration, the vibration of the atoms in the molecule with respect to each other, and the rotation of the molecule. Therefore, the location of the band system in the visible or ultraviolet region of the spectrum is determined by the magnitude of the energy changes associated with these transitions. All bands of a band system are associated with the change in electron configuration. The position of band in a band system is associated with a change in vibrational energy; changes in the rotational energy determine the location of the different lines.

Changes in energy of a molecule due to a change in rotational energy are an order of magnitude smaller than those due to vibrational changes which, in turn, are an order of magnitude smaller than the energy changes due to a

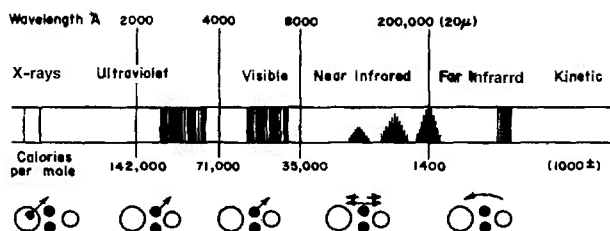

Figure 6-2. Various Types of Spectra and Corresponding Electronic, Vibrational and Rotational Motion

change in electronic configuration of the molecule (Figure 6-2). The relatively small amounts of energy corresponding to emission or absorption in the far infrared and microwave regions are due to changes in rotational energy of the molecule. The spectrum associated with these changes is called the rotation spectrum. The energy changes corresponding to the spectrum found in the near infrared are associated with changes in vibrational energy. The superimposition of the effects due to rotation, on those due to changes in vibrational level, result in the more complex vibration-rotation spectrum. As already indicated, the band system found in the visible and ultraviolet is due to the superimposition of energy changes due to changes in electron and configuration in vibration and rotation.

#### 6-2.2.2 Continuous Spectra<sup>21,24,25</sup>

A continuous emission spectrum in the visible region is a continuous brightly colored band extending from color to color. Incandescent solids, liquids, and gases, under high pressures, produce a more or less continuous spectrum which may extend without interruption from the extreme ultraviolet through the extreme infrared. The energy in any range,  $h$  to  $(\lambda + dh)$ , of wavelengths of a continuous spectrum is a continuous function of the wavelength so that the radiation is characterized by a continuum of wavelengths.

While continuous spectra are generally produced by incandescent solids, liquids, and gases; regions of continuous emission or absorption may result in gases at low pressure when at least one of the energy states involved in the transition is unquantized, possessing free kinetic energy. These continua, therefore, correspond to processes such as ionization, recombination and association.<sup>25,26</sup>

### 6-2.3 RADIATION SOURCES

Radiation sources can be classified in terms of the spectral distributions of their radiation and in terms of the manner in which this radiation is excited. Continuous radiation is generally produced by hot solids (Paragraph 6-2.2.2). Although light produced by certain lasers is very nearly monochromatic, there is no source of strictly monochromatic radiation. A narrow range of wavelengths can be obtained by isolating, with a monochromator or filters, one of the bright lines produced in emission by certain elements. A wider range of wavelengths (however manifest in the visible spectrum to give the sensation of a color) can be isolated by similar methods from sources producing band or continuous spectra.<sup>27</sup>

#### 6-2.3.1 Thermal Radiation Sources

Many radiation sources are based, at least in part, on the emission from a material heated to a high temperature. The radiation produced is continuous in nature, resembling that of a blackbody.

##### 6-2.3.1.1 Blackbody

A "blackbody" is an idealized body which will absorb all the radiant energy falling upon it. A blackbody can be approximated experimentally by an enclosure having a very small opening in one wall through which radiation may enter or leave. According to the Stefan-Boltzmann Law, the total radiation  $E$  emitted by a blackbody at an absolute temperature  $T$  is:

$$E = \sigma T^4 \quad (6-6)$$

where  $\sigma$  is a constant equal to  $7.56 \times 10^{-5}$  erg  $\text{cm}^{-2}$   $\text{deg}^{-4}$ . The intensity of radiation from a blackbody at a given temperature varies with the wavelength according to Planck's Equation:

$$E_\lambda = \frac{2\pi c^2 h}{\lambda^5 (e^{hc/k\lambda T} - 1)} \quad (6-7)$$

where  $E_\lambda$  is the radiance of wavelength  $\lambda$ ,  $c$  is the velocity of light,  $k$  is Boltzmann's constant, and  $h$  is Planck's constant. This equation, which is plotted at various constant temperatures in Figure 6-3, gives calculated values which are in extremely good agreement with the intensity values deter-

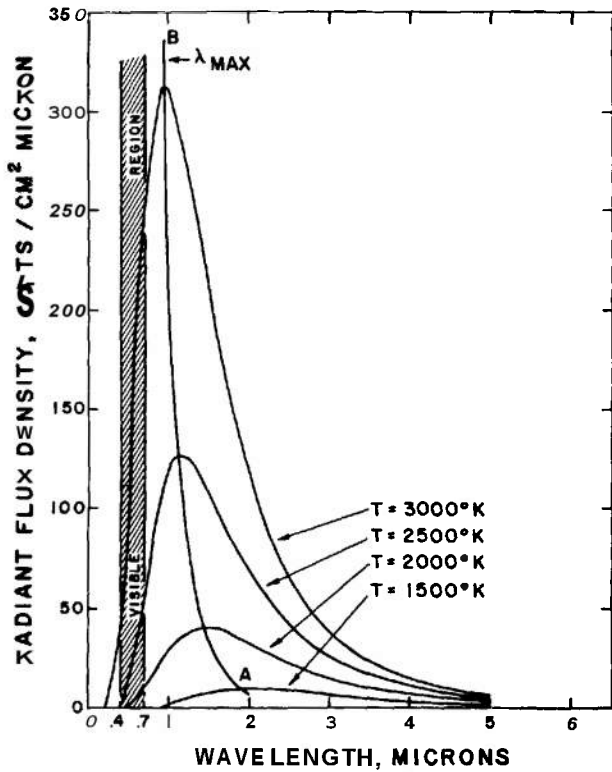

Figure 6-3. Planck's Law: Radiance as a Function of Wavelength for Various Temperatures

mined experimentally. The function has a single-valued maximum, for each temperature, which varies with temperature along curve AB in Figure 6-3. The wavelength of the maximum is given by the equation :

$$\lambda_{max} = \frac{2897}{T} \quad (6-8)$$

and the radiance at  $\lambda_{max}$  is given by :

$$E_{\lambda_{max}} = 1.178 \times 10^{-7} T^5 \quad (6-9)$$

As shown in Figure 6-4, the amount of energy radiated in any given wavelength region by a constant temperature blackbody radiator increases continuously but at different rates relative to the increase in the total amount of radiation, with temperature. Therefore, as shown in Figure 6-5, the efficiency of conversion of thermal energy into radiation in a particular band varies with the temperature and exhibits a maximum. As the wavelength of the band increases, the temperature

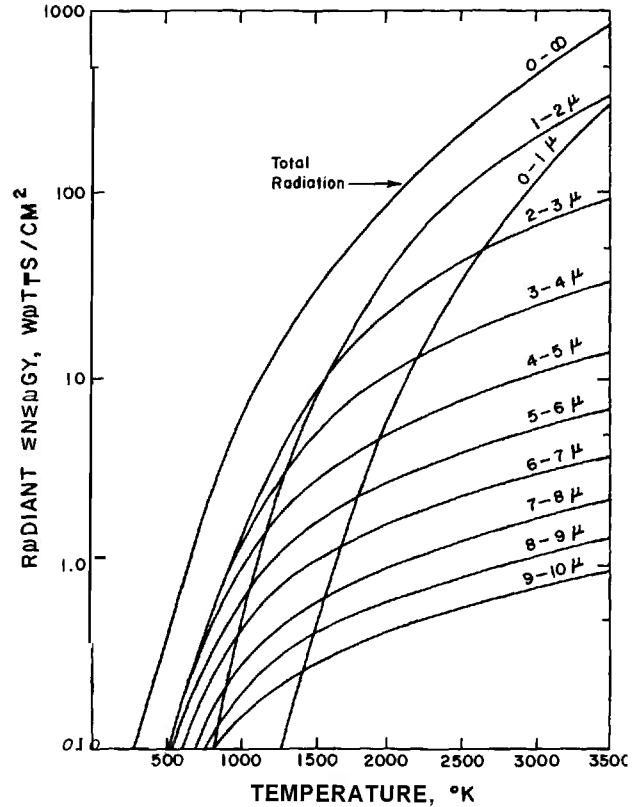

Figure 6-4. Radiant Energy in Different Wavelength Bands as a Function of Temperature

for maximum efficiency decreases as does the value for the maximum efficiency.<sup>28</sup>

### 6-2.3.1.2 Graybody

A graybody, or nonselective radiator, radiates at every wavelength an amount of energy bearing a constant ratio to the amount radiated by a blackbody at the same absolute temperature. This ratio is called the emissivity and is less than one for all solid radiators, but may closely approach unity in some cases for an extended wavelength region. Thus, the spectral distribution is exactly the same as that for a blackbody but the total energy radiated is less. Several solid materials, including platinum, iron, tungsten, and carbon, are very nearly nonselective radiators over a fairly wide range of wavelengths.

### 6-2.3.1.3 Incandescent Sources

Actual solid radiators are not "black" and their total emission is less than that of a black-

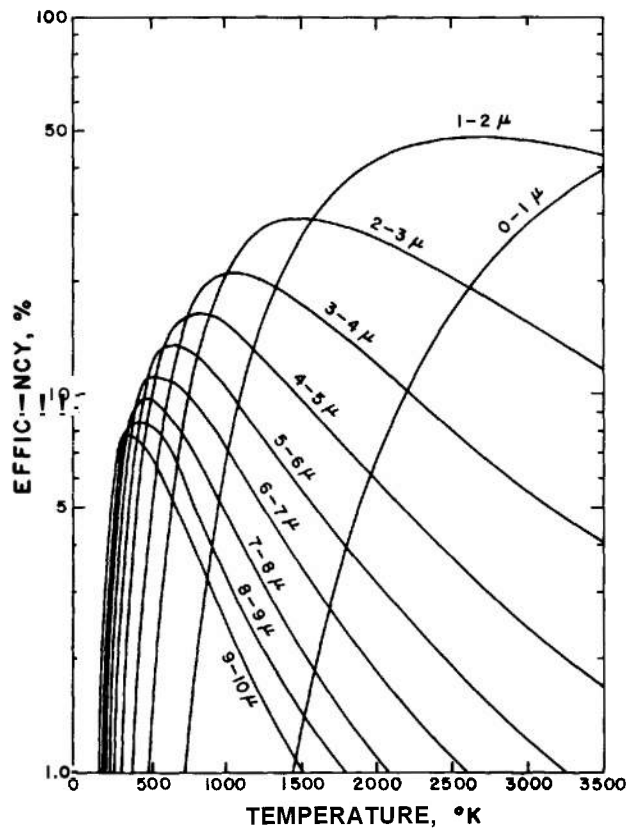

Figure 6-5. Isothermal Efficiencies: Fraction of Energy Emitted by an Isothermal Radiator in Various Wavelength Bands as a function of Temperature

body. In addition, their emissivity varies with the wavelength and actual radiators are not gray-bodies. The radiation is thermal if Kirchoff's Law applies, and the ratio of emissive to absorptive powers is a constant for each wavelength and temperature. Application of this law distinguishes between incandescence or thermal radiation, and luminescence or radiation excited by other methods.<sup>23</sup>

While there are materials, such as carbon, whose emissivity is nearly constant with wavelength, the emissivity of certain other materials is strongly wavelength-dependent. If the emissivity is high in the visible region and relatively low in other spectral regions (especially infrared), a larger portion of the total radiation will be in the visible and the heat-to-light conversion efficiency is improved. As an example, Welsbach mantles, which are impregnated with thorium and

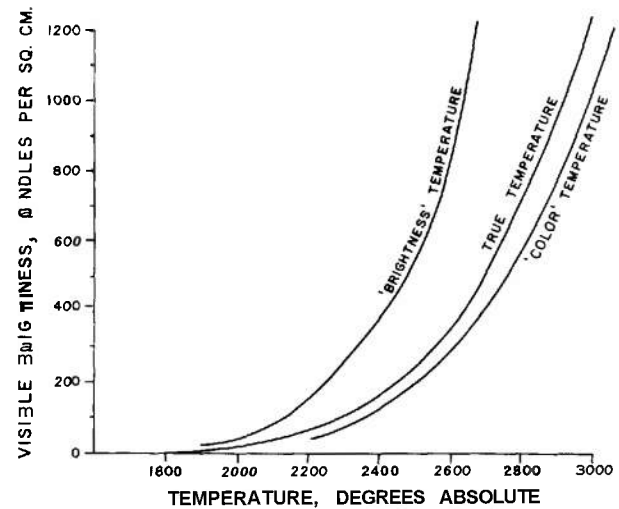

Figure 6-6. "Optical" Temperatures of a Tungsten Filament

cerium oxides, have a low emissivity in the infrared. When heated by a relatively nonluminous flame, a larger proportion of energy is radiated in the visible region. The efficiency of a Welsbach mantle as a light source is also due, in part, to the catalytic activity of the oxides so that the chemical reaction is faster and, therefore, the heat production greater near the mantle.

Temperatures of incandescent sources can be estimated from their total radiation by use of Stefan's Law, according to which the total radiation  $\approx 5.67 \times 10^{-5} T^4$  ergs per second per square centimeter. Temperatures determined in this way are called radiation temperatures. If temperatures are estimated from the visible brightness at a particular wavelength, they are called brightness temperatures. If temperatures are estimated on the basis of the best fit of their emission curve to a blackbody in the visible region, they are called color temperatures. While it is possible that temperatures determined by these methods may differ widely, in extreme cases, from the true temperature, the difference is usually less than a hundred degrees for incandescent solids such as furnaces and lamp filaments (Figure 6-6).

### 6-2.3.2 Luminescence

Luminescence results when a process leads directly to an atom or molecule in an excited state, from which it can return to a lower energy state



a particular light source is not an easy task. Theoretically, this can be accomplished for the  $Y$  value by multiplying the ordinate of the  $Y$  curve in Figure 6-10 at each wavelength by the radiant flux of the light source at the wavelength and summing over the visible spectrum. The  $X$  and  $Z$  values may be found by a like process and the chromaticity coordinates  $x$ ,  $y$  and  $z$  can be calculated. In practice, it is difficult to match exactly the I.C.I. tristimulus curves; however, several methods have been suggested<sup>31</sup> which give fairly good results. The more widely used methods incorporate barrier layer photocells and correction filters.

#### 6-2.5.4 Munsell Color System<sup>31</sup>

The Munsell color system specifies a surface color by giving, for usual viewing conditions, its position on a more or less arbitrary hue (Munsell hue), lightness (Munsell value), and saturation (Munsell chroma) scales having nearly perceptually uniform steps. The Munsell value varies from zero for an ideal black surface having a luminous reflectance equal to zero, to ten for an ideal white diffusing surface having a luminous reflectance equal to one. Munsell chroma is expressed in arbitrary units intended to be perceptually of the same size regardless of value and hue. The strongest **known** pigment colors have chromas of about 16 neutral grays; black and white have a zero chroma value. Munsell hue is expressed on a scale intended to divide the hue circle (red, yellow, green, blue, purple, and black to red) into 100 perceptually equal steps.

The pocket edition of the **Munsell Book of Color** has been widely used as a color standard. It consists of forty constant hue charts where all color samples making up a chart have the same hue. The color samples making up the chart are arranged in rows and columns, the rows being chroma at constant Munsell value and the columns being value scales at constant Munsell chroma. Comparison of an **unknown** color with these two families of scales gives, by interpolation, the Munsell value and Munsell chroma of the unknown color. Interpolation between the constant hue charts gives the Munsell hue.

#### 6-2.5.5 Color Value

A commonly used designation for describing the color of a pyrotechnic composition is the color value. This is defined as the ratio of the apparent light intensity (through specific filters) to the total (or unfiltered) intensity. This is usually accomplished through the use of two photocells, one of which is equipped with a glass filter. The ratio obtained is a measure of the visual depth of color of the flame.

#### 6-2.6 ATMOSPHERIC EFFECTS

Absorption and scattering can change the energy distribution of light passing through the atmosphere. While the absorption in parts of the ultraviolet and infrared regions may be very large, the more important effects in the visible region are due to scattering. A light beam passing through a length  $x$  of the atmosphere is attenuated from the initial flux  $F_0$ , to a flux  $F$ , by an amount which depends mainly on the scattering coefficient  $\sigma$ , even though individual layers may absorb light.

$$F = F_0 e^{-\sigma x} \quad (6-13)$$

For particles whose radii are less than approximately  $\frac{1}{10}$  the wavelength of the light  $\lambda$ , the scattering coefficient  $\sigma$  can be approximated by:

$$\sigma = Ah^4 \quad (6-14)$$

where  $A$  is effectively a constant. The theory for spherical particles comparable in size to the wavelength of light results in extremely complicated expressions for the scattering coefficient.

As discussed in greater detail in Paragraph 7-2.1.1, smaller droplets preferentially scatter the shorter wavelengths so that the color of the transmitted light will shift toward the red. The preferential scattering of the shorter wavelengths decreases with increasing particle size until the particle radii become slightly greater than that corresponding to the maximum for red light. At this time the transmitted light appears blue or green. There is little preferential scattering for particles whose radii are greater than one to two microns. Little or no variation in transmission with wavelength is observed for fogs or thin clouds because their drop size distribution is broad. If the scattering particles are polydispersed, but

terms of its visual effect. The lumen has the same dimensions as power. It has been found by experiment that, for the so-called normal observer, one lumen is equivalent to 0.00161 watt of monochromatic green light of a wavelength corresponding to the maximum in the visibility curve, 555 millimicrons. The number of lumens produced by one watt of radiant power is called the luminous efficiency of the source. For a monochromatic source, the luminous efficiency is obtained by multiplying the relative visibility for the wavelength in question by 680 lumens/watt.<sup>29</sup>

#### 6-2.4.1 Instruments for Measuring Light Intensity

Instruments used for the measurement of light intensity can be divided into two general categories: (1) those which use the heating effect of the radiation, and (2) those which make use of quantum effects of the radiation.

In the first category, the radiation absorbed by the receiver raises its temperature which is sensed by some appropriate means. The thermocouple uses the thermoelectric effect while the bolometer uses the change in resistance of a resistance element, which may be a semiconductor, to sense this temperature rise. Generally, both of these detectors are spectrally nonselective in their response to radiation, i.e., they absorb like graybodies. In another type of thermal detector, which may be selective in its response, the radiation is absorbed by a gas. The temperature change produced in the gas, which is confined to a very small volume, is sensed as a pressure rise.

The second category of detectors are the photo-detectors which, in principle, count the number of quanta of radiation. An example of a common detector in the second category is the photocell which is a photoemissive detector. It depends for its operation on the ejection of electrons from a specially prepared surface by the incident quanta of radiation. In a vacuum photocell the response to incident radiation is a linear function of the light intensity. The electrons emitted are drawn to the anode from the sensitized cathode by a relatively small voltage applied to the electrodes. Gas-filled photocells are nonlinear in their response to incident light intensity, but are more sensitive than the vacuum type because ionization of the gas

by collision can be utilized to increase the number of electrons reaching the anode for a given amount of incident light. Still more sensitive photocells, known as photomultipliers, use the phenomenon of secondary electron emission to produce an internal amplification of the order of one million. In all cases, the response of the photocathode surface is spectrally selective and is determined by the basic material and its preparation. Another type of light-sensitive cells is the photoconductive cell, in which the action of light causes an increase in the electrical conductivity of the device. The selenium cell is an example. A third type of detection utilizes the photovoltaic effect in which a voltage is produced across the interface separating a semiconductor from a conductor by light incident on the interface. A common example of this type of detector is the copper-cuprous oxide cell. All of these detectors—photoemissive, photoconductive, or photovoltaic—have a selective spectral response, as do photochemical reactions, including photography. The spectral response of photochemical reactions is selective because only the light which is absorbed will produce a photochemical effect. Actimeters use photochemical reactions in which the quantum yield, which is equal to the number of induced reactions divided by the number of quanta absorbed, has been accurately determined.

#### 6-2.4.2 Measurement of the Light Output of Flares

Flare output measurements are usually made in a photometric tunnel. This tunnel is a light-tight structure with a fan to remove smoke and with instruments to measure the brightness, color, and burning time of a flare. The inside of the tunnel is usually flat black and baffled to eliminate reflections. The tunnel is usually built in three parts: a burning room, which contains the burning table, ignition apparatus, and exhaust fan; a long tube section from 50 to 100 feet long which houses the photometric transducers; and an instrument room, which houses the recording instruments and provides a place for the personnel to work. More complete measurement capability for a tunnel would include the ability to determine the visible spectral output of flares, ultraviolet and infrared outputs, and flame temperatures. The tunnel must have calibrating lights and color filters for calibra-

tion of the instruments. Luminous intensity measurements in terms of candlepower are often determined by an instrument which consists of a barrier layer photocell, filters, and a microammeter. This illuminometer is placed at an accurately known distance from the point at which the candle or assembly is to be burned and is then calibrated by means of a standard incandescent white light source. During the burning of the item, illuminometer readings are taken at predetermined time intervals throughout the burning period and the average of these readings is calculated. In many cases the output of the detector is displayed on a graphic recorder. In this case, the output of the photocell is fed into the recorder which has been calibrated so that the anticipated light output will produce a nearly full scale reading. A graphic record is superior to readings taken with an illuminometer because all variations during burnings are recorded and thus are available for future study. The area under the curve thus obtained represents the candlesecond value of the tested item. An integrator, which gives the candlesecond value of the composition directly, is coupled with the photocell, thus avoiding the time consuming and less accurate method of estimating or planimetrying the graphic record.

The state of the science in photometry is not yet precise, and measurement errors within  $\pm 10\%$  on flares are as good as can now be attained. Specification MIL-C-18762 covers general requirements although later refinements have been made at each military installation. Representative facilities for these measurements are to be found at Picatinny Arsenal, Dover, New Jersey; Naval Ammunition Depot, Crane, Indiana; Naval Ordnance Test Station, China Lake, California; and Naval Ordnance Laboratory, White Oak, Silver Spring, Maryland.

#### 6-2.4.3 Intensity

The intensity of a point source, in any direction, is defined as the light ~~flux~~ in lumens per unit solid angle (per steradian) in that direction, or

$$I = \frac{dF}{d\omega} \quad (6-10)$$

where  $I$  is the intensity in candela and  $dF$  is the lumens of flux within a small solid angle of  $d\omega$

steradians. A unit point source, emitting light uniformly in all directions, radiates  $4\pi$  lumens. The unit of luminous intensity—adopted by the International Commission on Illumination in 1948—is the candela. It is of such a magnitude that a black-body radiator at the temperature at which pure platinum solidifies has a luminance of 60 candela per square centimeter.<sup>30</sup> An earlier unit of luminous intensity, the candle, is equal to 1.02 candela. Another unit, candlepower, also has been widely used to express the luminous intensity of a light source. While the use of these units should be discouraged, they have been widely used by many pyrotechnic investigators. Therefore, the terms candela (preferred), candle, and candlepower will be used interchangeably in this handbook.

#### 6-2.4.4 Brightness

The concept of brightness is required because most sources are not points and the concept of intensity is not readily applicable to extended sources. The brightness of an extended source is expressed in candela per square centimeter of emitting surface.

#### 6-2.4.5 Illumination

The illumination of a surface is the amount of light flux (lumens) incident upon a unit area of surface. An illumination of a lumen per square foot is called a foot-candela. The illumination  $E$  of a spherical surface of radius  $r$ , enveloping a point source of intensity  $I$ , is given by:

$$E = \frac{F}{A} = \frac{4\pi I}{4\pi r^2} = \frac{I}{r^2} \frac{\text{lumens}}{\text{unit area}} \quad (6-11)$$

for a plane surface at a distance  $x$  from a point source of intensity  $I$ :

$$E = \frac{I}{x^2} \cos \theta \quad (6-12)$$

where  $\theta$  is the angle between the source vector and the normal to the surface.

#### 6-2.4.6 Photometric Units

The units employed in photometry are a continuing source of difficulty, especially for the novice. A strong effort is being made to secure greater uniformity, reduce the number, and pro-

**TABLE 6-1**  
**CONVERSION FACTORS FOR PHOTOMETRIC UNITS**

<i>Physical</i>			<i>Psycho Physical</i>		
<i>Radiator-source of Radiant Energy</i>			<i>Luminator-source of Luminous Energy</i>		
<i>Radiometry</i>	<i>Symbol</i>	<i>mks units</i>	<i>Photometry</i>	<i>Symbol</i>	<i>mks units</i>
<i>Radiant</i>			<i>Luminous</i>		
energy		joule	energy	Q	talbot
density		joule/m <sup>3</sup>	density	q	talbot/m <sup>3</sup>
flux		watt	flux	F	lumen
emittance	W	watt/m <sup>2</sup>	emittance	L	lumen/m <sup>2</sup>
intensity		watt/sterad	intensity	I	lumen/sterad
radiance	N	watt/sterad-cm <sup>2</sup>	radiance	B	lumen/sterad-m <sup>2</sup>
irradiance	H	watt/m <sup>2</sup>	illumination	E	lumen/m <sup>2</sup>
<i>Spectral</i>			<i>Luminous</i>		
reflectance			reflectance	r	
<i>Spectral</i>			<i>Luminous</i>		
transmittance			transmittance	t	

*Illumination*

$$1 \text{ lumen/ft}^2 = 1 \text{ foot-candle} = 10.764 \text{ lumen/meter}^2 = 10.764 \text{ lux}$$

$$1 \text{ lumen/meter}^2 = 1 \text{ meter-candle} = 1 \text{ lux} = 10^{-4} \text{ phot}$$

*Brightness*

$$1 \text{ foot-lambert} = 1 \text{ equivalent foot-candle}$$

$$1 \text{ lambert} = 3183 \text{ candle meter}^{-2} = 296 \text{ candle ft}^{-2} = 2.054 \text{ candle inch}^{-2}$$

*Exposure*

$$1 \text{ meter-candle-second} = 1 \text{ lumen-second meter}^{-2}$$

vide more logic in photometric units.<sup>7,8</sup> Some of the more common photometric units are summarized in Table 6-1. The units of photometry are often applied, incorrectly, to measurements of infrared or ultraviolet radiation, or to describe the sensitivity of photographic emulsions to radiation. Such usage should be avoided and radiometric units used for these spectral regions.

### 6-2.5 COLOR<sup>31,32</sup>

In a physical sense, color is determined by the wavelength(s) or spectral energy distribution contained in a light beam. Physiologically, color is the sensation produced as the result of the excitation of the retina of the eye by these waves. Colors are compared in terms of hue, saturation or purity, and brightness; all of which influence the color sensation produced. Hue refers to the color, i.e., red, green, or blue. Not all hues are observed in the spectrum of sunlight. The purples are notably absent. The sensation is a measure of the con-

tent of white light; only monochromatic colors are completely saturated. Brightness or lightness is a measure of the amount of light being emitted or reflected from the colored light sources or colored object. Brightness applies to luminous sources while the term lightness refers to color seen because of reflected light. These three aspects of color can be represented on a color solid (Figure 6-7) where hue changes around the circle, lightness increases upward, and saturation increases outward from the axis.

#### 6-2.5.1 Additive Color

In principle, it is possible to produce any hue by a suitable combination of three primary colors, one from the middle of the visible spectrum, green, and one from either end, blue-violet and red. As indicated by the additive color circles in Figure 6-8, proper proportions of red and green light will produce yellow. If the proper amount of blue-purple light is added, white light is produced.

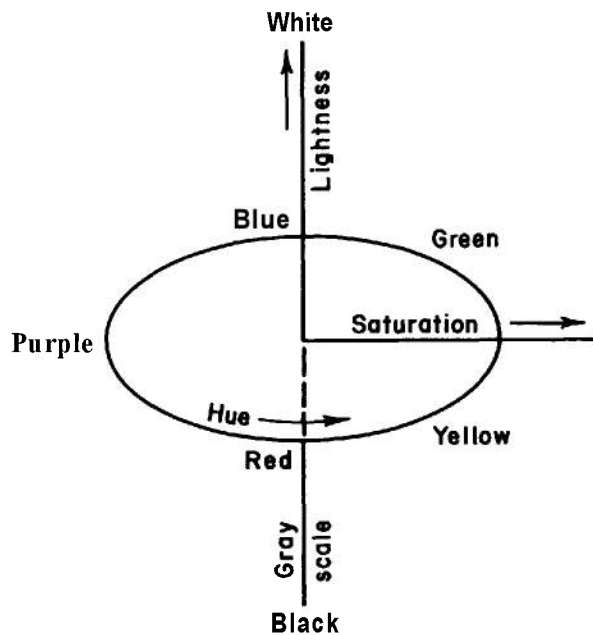

Figure 6-7. Dimensions of the Psychological Color Solid

Colors such as yellow and blue-purple, that produce white light when added together, are called complementary colors. The complementary color for red is a blue-green (cyan), for green is a red-purple (magenta), and for blue-purple is, as indicated earlier, yellow.<sup>7</sup>

6-2.5.2 Subtractive Color

The light incident on a nonluminous object may be partly reflected, partly absorbed, and partly transmitted. If the incident light is white, the transmitted light will be the color which is complementary to the color which is selectively absorbed. For example, the light transmitted will be red if blue-green is selectively absorbed. Opaque bodies, which are seen because light is diffusely reflected from them, also appear colored because of selective absorption of light which penetrates a short distance beneath the surface before it is reflected.

6-2.5.3 Chromaticity Coordinates

The tridimensional color stimulus required by the eye has been studied in detail and has led to a precise method for expressing a particular light

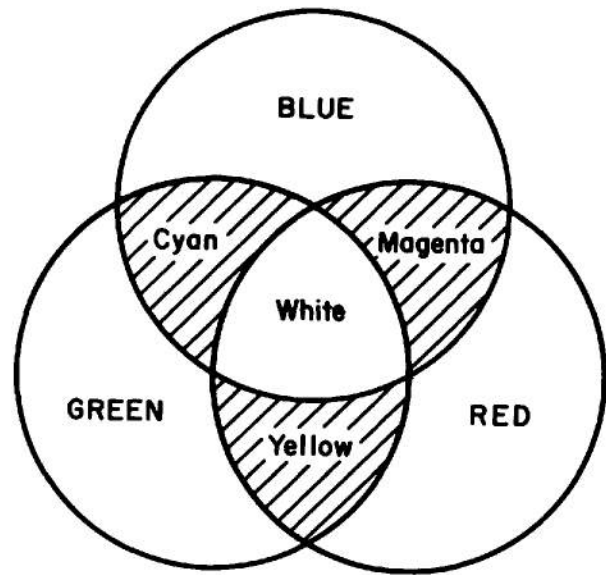

Figure 6-8. Additive Mixture of Primary Colors

type. It was found that only the mutual ratios of three primary colors are of importance in determining the “color according to the eye” of a given light type. These ratios may be described by expressing each primary as a part of the total impression of the light type obtained by the eye. Thus, for red, green, and blue, respectively, the ratios are:

$$\frac{r}{r + g + b} ; \frac{g}{r + g + b} ; \frac{b}{r + g + b}$$

which necessarily total one, and, as a result, only two need be designated to determine the light type. A particular color or color point, therefore, may be displayed on an *x-y* plane, and, due to the mutuality of the components, will fall within an area bounded by a 45-degree triangle. However, the actual area containing color points varies with the particular set of color sensitivities used to determine the color points of the various light types. Each set produces a “color triangle” with its own shape.

In order to effect a standardization, the International Commission on Illumination (I.C.I.),\* in 1931, recommended that all subsequent color data

\* Now known as C.I.E., Commission Internationale de l’Eclairage.

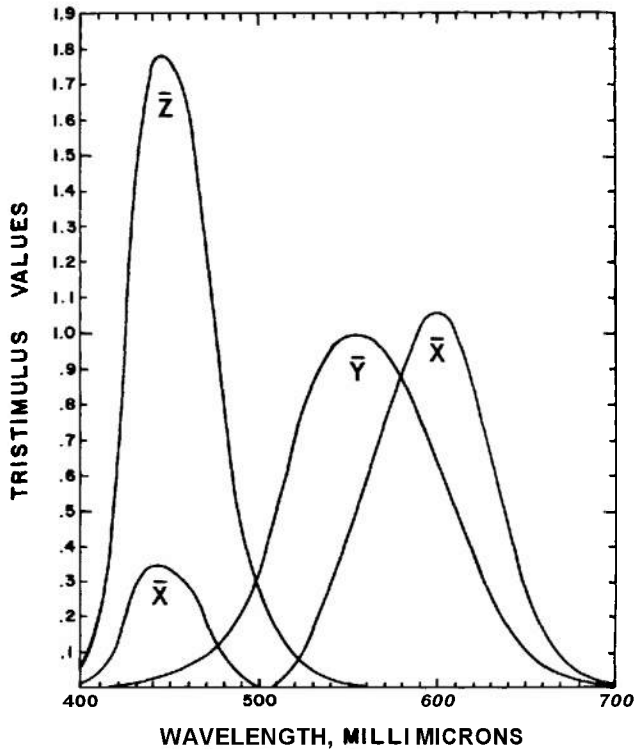

Figure 6-9. Tristimulus Values of the Spectrum Colors According to the 1931 I.C.I. Standard Observer

be expressed in terms of the same tristimulus system so that the results would be immediately comparable. The Standard Colorimetric Coordinate System (X, Y, Z color triangle) was introduced which is based on the color sensitivity curves shown in Figure 6-9. These curves are the result of color comparison tests conducted on many observers and compiled to produce those for the "standard observer." The primary colors were selected so as to produce no tristimulus value less than zero (avoiding the use of negative values in computations). Further, the curve for the Y-factor is identified with the eye-sensitivity curve for light, which forms the basis of photometry. The values of X, Y, Z are the amounts of the three I.C.I. primaries required to color match a unit amount of energy having the indicated wavelength. The chromaticity coordinates for each wavelength are obtained from the values of X, Y, and Z by means of the ratios:

$$x = \frac{X}{X + Y + Z}, y = \frac{Y}{X + Y + Z}, z = \frac{Z}{X + Y + Z}$$

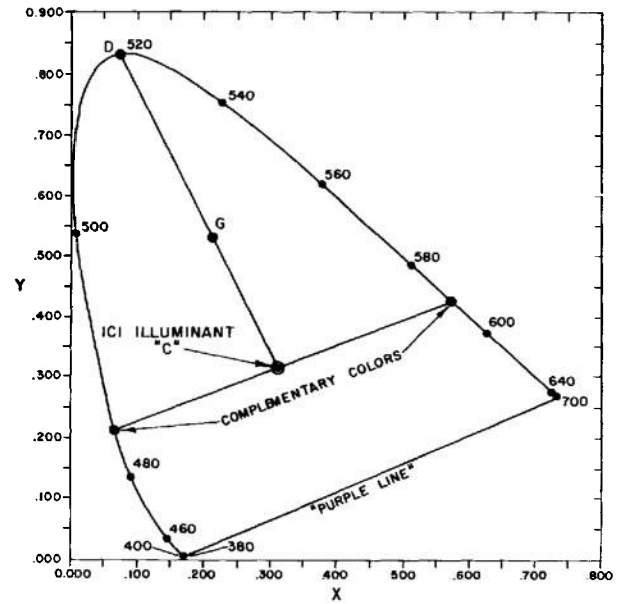

Figure 6-70. C.I.E. Chromaticity Diagram

Since, as indicated earlier, only two coordinates are required to describe the light type, the values of X and Y are plotted on a chromaticity diagram (Figure 6-10) and form a loci of monochromatic spectrum colors. The line drawn between 380 millimicrons and 700 millimicrons forming the "base" of the triangle is called the "purple line" along which no perceptible colors exist. The center of the triangle (C) is the equal energy or "white point" and has been designated by the I.C.I. (or C.I.E.; used interchangeably) as the light produced by "Illuminant C" which corresponds very closely to average daylight. Complementary colors will fall on a straight line passing through Illuminant C. Also, any color can be considered as a mixture of Illuminant C and spectrum light having a wavelength given by the intersection of a straight line through Illuminant C and the given color G, with the Chromaticity Curve D (Figure 6-10). This wavelength D is called the dominant wavelength. In addition, a mixture of two color points anywhere on the diagram will produce a color which is located on a line between the two initial colors. Other useful aspects of the Chromaticity Diagram can be found in the references.<sup>32</sup>

The assignment of chromaticity coordinates to

a particular light source is not an easy task. Theoretically, this can be accomplished for the  $Y$  value by multiplying the ordinate of the  $Y$  curve in Figure 6-10 at each wavelength by the radiant flux of the light source at the wavelength and summing over the visible spectrum. The  $X$  and  $Z$  values may be found by a like process and the chromaticity coordinates  $x$ ,  $y$  and  $z$  can be calculated. In practice, it is difficult to match exactly the I.C.I. tristimulus curves; however, several methods have been suggested<sup>81</sup> which give fairly good results. The more widely used methods incorporate barrier layer photocells and correction filters.

#### 6-2.5.4 Munsell Color System<sup>81</sup>

The Munsell color system specifies a surface color by giving, for usual viewing conditions, its position on a more or less arbitrary hue (Munsell hue), lightness (Munsell value), and saturation (Munsell chroma) scales having nearly perceptually uniform steps. The Munsell value varies from zero for an ideal black surface having a luminous reflectance equal to zero, to ten for an ideal white diffusing surface having a luminous reflectance equal to one. Munsell chroma is expressed in arbitrary units intended to be perceptually of the same size regardless of value and hue. The strongest known pigment colors have chromas of about 16 neutral grays; black and white have a zero chroma value. Munsell hue is expressed on a scale intended to divide the hue circle (red, yellow, green, blue, purple, and black to red) into 100 perceptually equal steps.

The pocket edition of the Munsell Book of Color has been widely used as a color standard. It consists of forty constant hue charts where all color samples making up a chart have the same hue. The color samples making up the chart are arranged in rows and columns, the rows being chroma at constant Munsell value and the columns being value scales at constant Munsell chroma. Comparison of an unknown color with these two families of scales gives, by interpolation, the Munsell value and Munsell chroma of the unknown color. Interpolation between the constant hue charts gives the Munsell hue.

#### 6-2.5.5 Color Value

A commonly used designation for describing the color of a pyrotechnic composition is the color value. This is defined as the ratio of the apparent light intensity (through specific filters) to the total (or unfiltered) intensity. This is usually accomplished through the use of two photocells, one of which is equipped with a glass filter. The ratio obtained is a measure of the visual depth of color of the flame.

#### 6-2.6 ATMOSPHERIC EFFECTS

Absorption and scattering can change the energy distribution of light passing through the atmosphere. While the absorption in parts of the ultraviolet and infrared regions may be very large, the more important effects in the visible region are due to scattering. A light beam passing through a length  $x$  of the atmosphere is attenuated from the initial flux  $F_0$ , to a flux  $F$ , by an amount which depends mainly on the scattering coefficient  $\sigma$ , even though individual layers may absorb light.

$$F = F_0 e^{-\sigma x} \quad (6-13)$$

For particles whose radii are less than approximately  $\frac{1}{10}$  the wavelength of the light  $\lambda$ , the scattering coefficient  $\sigma$  can be approximated by:

$$\sigma = A\lambda^4 \quad (6-14)$$

where  $A$  is effectively a constant. The theory for spherical particles comparable in size to the wavelength of light results in extremely complicated expressions for the scattering coefficient.

As discussed in greater detail in Paragraph 7-2.1.1, smaller droplets preferentially scatter the shorter wavelengths so that the color of the transmitted light will shift toward the red. The preferential scattering of the shorter wavelengths decreases with increasing particle size until the particle radii become slightly greater than that corresponding to the maximum for red light. At this time the transmitted light appears blue or green. There is little preferential scattering for particles whose radii are greater than one to two microns. Little or no variation in transmission with wavelength is observed for fogs or thin clouds because their drop size distribution is broad. If the scattering particles are polydispersed, but

smaller than optimum size, the transmitted light will be more red than the incident light, accounting for the deep red of the transmitted light from the setting sun.

### 6-3 CONSOLIDATED ILLUMINATING DEVICES

A consolidated illuminating composition is formed by mechanically pressing, extruding, or casting finely divided illuminating composition into some solid shape which often has a candle-like form. When such an item burns in a propagative fashion, the flame radiates energy in the ultraviolet, visible, and infrared region of the spectrum. In most cases, less than 10 percent of the radiant energy is in the visible region. The distribution and relative intensity characteristics of the radiation produced, in any given region of the spectrum, are determined basically by the products of the burning reaction which emit in that region and the temperature reached by the emitting species.

Light-producing pyrotechnic devices are characterized for military purposes by luminous intensity, color value (hue and saturation) of the flame, and burning rate. Sensitivity of the composition to impact, static electricity, and friction should be a minimum for safety. The ignition temperature, ignitibility, stability, and hygroscopicity are important in determining the certainty of functioning.

#### 6-3.1 ILLUMINATING FLARES

An illuminating flare produces a single source of illumination which is generally of high candlepower and substantial duration. Flares may be parachute-supported, towed, or stationary. While their primary function is illumination, they may be used for identification, ignition, location of position, or warning.

In general, a pyrotechnic illuminating flare should:<sup>33</sup> (1) produce essentially white light, (2) have an intensity in foot candles adequate to produce a brightness level from 0.1 to 1.0 foot-lambert on areas or targets with minimum reflectivity, and (3) burn at peak intensity for a minimum of thirty seconds and, preferably, in excess of one minute. (These values are desirable; however, where necessary, lower levels may be adequate. Illumination

**TABLE 6-2**  
**CANDLEPOWER REQUIREMENTS VERSUS**  
**HEIGHT OF ILLUMINATING SOURCE**

<i>Height Above Ground</i>	<i>Ground Brightness,</i>	
	<i>0.1</i>	<i>1.0</i>
100 ft	1,000*	10,000*
500 ft	25,000	250,000
1000 ft	100,000	1,000,000

\* Candlepower requirements necessary to provide specified illumination (0.1 and 1.0 fl) on the ground from given heights above the ground.

above 1.0 foot-lambert will generally require an unreasonable amount of illuminant.) Although it is often difficult to produce, white light provides the best illumination for the greatest range of possible conditions in the field. Since illuminating flares are used under field conditions where the location and recognition of unfamiliar objects are important, sufficient duration and intensity are required to complete the visual observation and to distinguish objects in the field from their background. Candlepower requirements necessary for adequate illumination, 0.1 to 1.0 foot-lambert, fl, when the flare is suspended above the ground, are given in Table 6-2.<sup>33</sup>

A diagram of a parachute suspended flare is shown in Figure 6-11 indicating the manner in which ground illumination  $E$  may be approximated from values of  $h$ , the height of the source;  $r$ , the radius of the desired illumination; and  $I$ , the intensity of the source. Intensity curves for various heights to produce a minimum value for  $E$  of .025 foot-candle are shown in Figure 6-12.

##### 6-3.1.1 Aircraft Flares

Flares for aircraft provide illumination for reconnaissance, observation, bombardment, landing, and also targets for practice firing of anti-aircraft guns. While details of flares vary with their purpose, flares for illumination have certain characteristics in common in that they all produce high-intensity white or colored light for an appreciable length of time. Most aircraft flares are parachute-supported to retard their speed of fall and thus provide illumination over a given



**TABLE 6-3  
CHARACTERISTICS OF VARIOUS ILLUMINATING FLARES**

<i>Item</i>	<i>Method of actuation</i>	<i>Time lapse from actuation to full function, sec</i>	<i>Burning time, sec</i>	<i>Candle-power, 10<sup>3</sup></i>	<i>Fall, fps</i>	<i>Max L, in.</i>	<i>Max dia, in.</i>	<i>Weight, lb</i>	<i>Max speed of airplane at time of release, mph</i>
<b>FLARE, AIRCRAFT:</b> guide, 1 min T6E1 (white) T7E1 (red) T8E1 (green)	Electricity	6 to 7	45 to 60	650 700 90	.....	5.4	5.46	.....	.....
<b>FLARE, AIRCRAFT:</b> parachute M8A1 (w/o suspension bands) (emergency night landing) M8A1 (training) (w/o suspension bands)	Release from airplane	3.0 to 5.0	165 to 19	350	8.0	25.42	4.25	17.6	200
M9A1	Fired from PISTOL, pyrotechnic, AN-M8	2.5	60 to 70	60	7.0	15.05	2.0	2.11	200
M26A1 (AN-M26) or M26 M26A1 (AN-M26) or M26 (w/blue band)	Released from airplane	5 to 92	195 ± 15	800 575	11.6	50.0 (fuzed)	8.0	52.5	150 (M26) 350 (M26A1)
M138 (T10E4) M139 (T10E6)		5 to 92	360 180	1,500 3,000	10	45.6	6.25	62	440
Mk 5 and Mods		variable	180	600	.....	27.0	4.75	18.0	.....
Mk 6 Mod 5 Mk 6 Mod 6 AN-Mk 8 Mod 1 AN-Mk 8 Mod 2		variable 90 120	180 180	1,000 500	..... 8.0	35.75 25.12	5.37 4.75	30.0 18	..... 250
3 minute, electrically operated 3 minute, Wiley SA 8	.....	1½	180	200	9.1	28	4.5	22	.....
<b>FLARE, AIRCRAFT:</b> tow-target, M50	Tow cable attached to airplane.	0	360	65	.....	22.8	2.62	7.13	120
<b>FLARE, AIRCRAFT:</b> towed Red, M77 (T18) Amber, M78 (T19) Green, M79 (T20)		0	360 ± 30	225 70 90	.....	23.34	4.55	21	200
<b>FLARE, SURFACE:</b> Airport, M76	Hand or electric squib	0	300 to 420	300 to 850	.....	31.33	4.26	27.6	
Parachute, trip, M48	Pressure or trip wire	3	20	110	3	9.75	5.5	5.0	
Trip, M49	Trip wire	0	55	40	.....	6.75	3.0	1.5	

area for a greater time interval. Aircraft flares also have some form of delayed ignition so that they will clear the aircraft and function at a desired altitude below it. Certain flares designed for use below the aircraft, such as those intended

for bombing purposes, are provided with shades to shield air-crew members from glare. Data for several aircraft flares are presented in Table 6-3. A typical aircraft parachute flare for night bombardment is shown in Figure 6-13, and its opera-

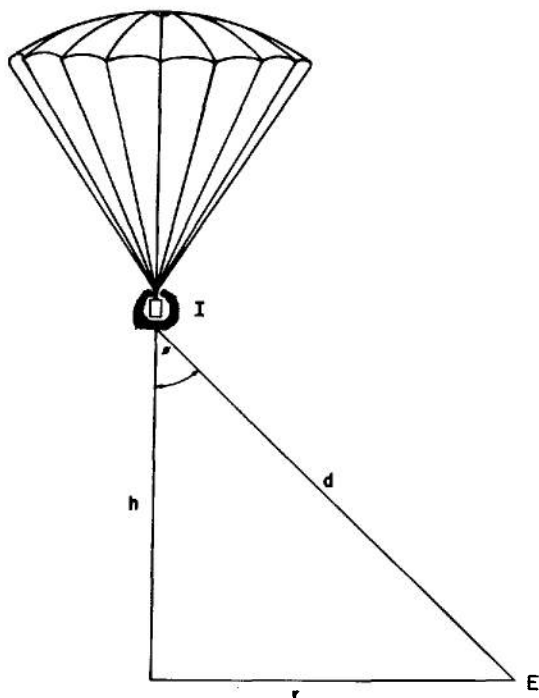

Figure 6-77. Illumination Diagram for Parachute Suspended Flare

tion is shown diagrammatically in Figure 6-14. A typical tow-target flare is illustrated in Figure 6-15.

### 6-3.1.2 Surface Flares

Flame-type surface flares are used for illumination during airplane landings in case of power failure at airports, or to outline boundaries of emergency landing fields. Mine- or grenade-type surface flares are used to illuminate targets and objectives, to aid in detection of infiltration or surprise attacks by enemy troops, and for recognition and signaling purposes. Data on several of these flares are presented in Table 6-3. A surface flare which is primarily used to give warning of infiltration by enemy troops is shown in Figure 6-16.

## 6-3.2 ILLUMINATION SIGNALS

Light-producing signals are much smaller and faster burning than flares and may consist of a

single parachute-supported star or from one to five freely falling stars, with or without colored tracers. To be effective, any signal must be recognized in addition to being detected. Characteristics of illuminating signals which are important in determining their effectiveness include intensity, duration, and the hue and saturation of the color.<sup>33</sup>

Illumination signals are used during the day as well as night. The brightness of the daylight sky requires a signal of increased intensity to provide adequate contrast. Depending on the location of the signal relative to the clouds and sun, and the brightness of the sky; the intensity of a signal adequate for night use must be increased by a factor of ten (twilight) to over 100,000 (bright daylight). Relatively little is known concerning the effects of flame duration on the detection and recognition of pyrotechnic illuminating signals. However, the burning time should be of sufficient duration that the signal can be detected, and the color should be of sufficient saturation so as to be recognized in a relatively short period of time.

Since color differences are often the basis for communication by signal flares, the relative effectiveness of the various color hues and their saturation is important. Since a signal used during daylight must often be observed against a sky (blue) background, red signals, even though requiring slightly more intensity at night, are most visible and most easily recognized in general usage.<sup>33</sup> Of the other methods, such as multiplicity, different shapes, sizes, patterns, or flashing of the signal—which could be used for communications—only multiplicity appears to be flexible enough for normal combat use.

### 6-3.2.1 Aircraft Illumination Signals

Aircraft signals used directly in connection with combat operations were originally intended for signaling from air to air or air to surface. Since the introduction of the pyrotechnic pistol and hand pyrotechnic projector, aircraft signals have also been used by ground troops for ground-to-ground and ground-to-air signaling. The signals are generally of one piece, rimmed case construction with a steel closing cap. Aircraft signals are fired from the pyrotechnic pistol or hand pyrotechnic projector.

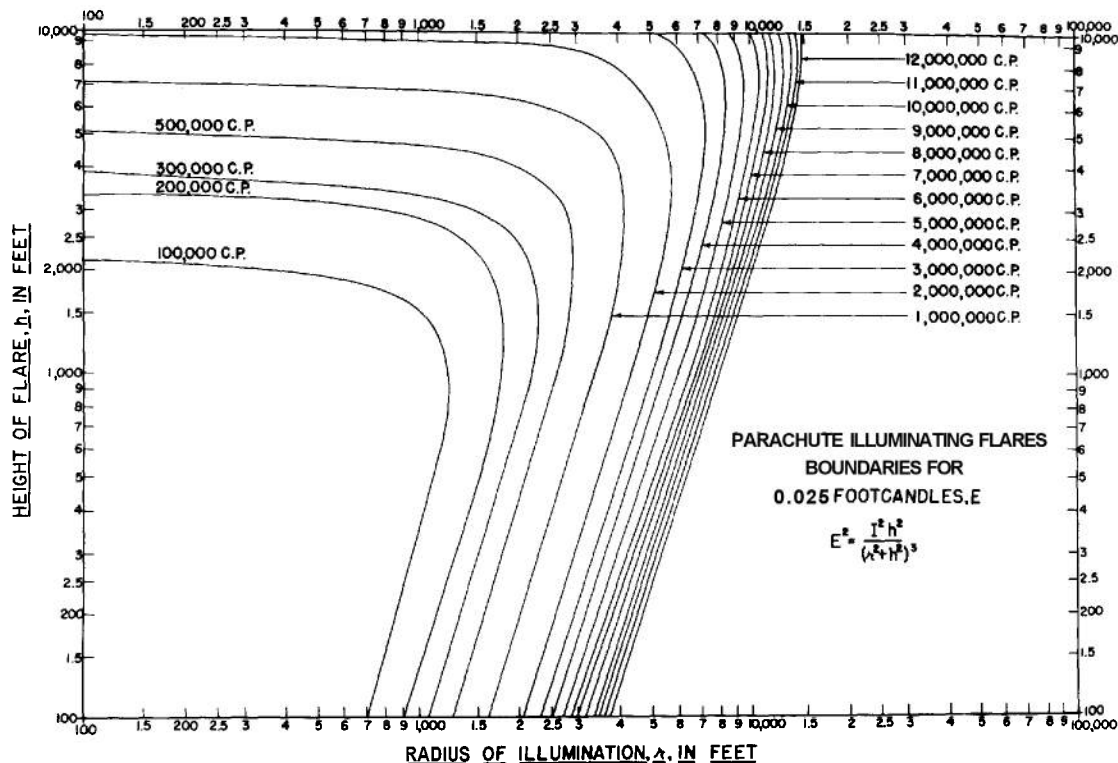

Figure 6-12. Intensity Curves for Various Parachute Flare Heights

Single-star aircraft signals, double-star signals, and tracer double-star signals contain red, green, or yellow light-producing candles of pyrotechnic composition. Stars can be distinguished at distances up to five miles at night and two to three miles in daylight.

Data on aircraft signals are presented in Table 6-4(A).

**6-3.2.2 Ground Illumination Signals**

These signals consist of devices which produce a signal when fired vertically into the air. The height of projection is from 600 to 700 feet. Data for some ground illumination signals are given in Table 6-4(B). A typical hand-held device is shown in Figure 6-17.

**6-3.3 TRACERS**

Tracer ammunition for both small arms and artillery is used for determining range and direct-

ing fire. In some small arms tracers the gilding metal or steel bullet jacket has, as shown in Figure 6-18, a cavity into which the tracer and its associated igniter compositions are loaded and compressed at 80,000 to 125,000 psi. Armor-piercing tracer ammunition contains a steel core which is inserted into the bullet jacket, as shown in Figure 6-19. The steel core has a cavity into which the tracer compositions are loaded. Some artillery projectiles have a cavity in the base into which the tracer and igniter compositions are pressed, as shown in Figure 6-20, at a pressure of over 100,000 psi. Other artillery projectiles use a separately-loaded tracer assembly which is fitted into the base of the projectile as illustrated in Figure 6-21. In some ammunition, the tracer composition initiates a charge which destroys the projectile after a definite time interval. In specific cases, this may be the only function performed by the composition loaded in the tracer cavity.

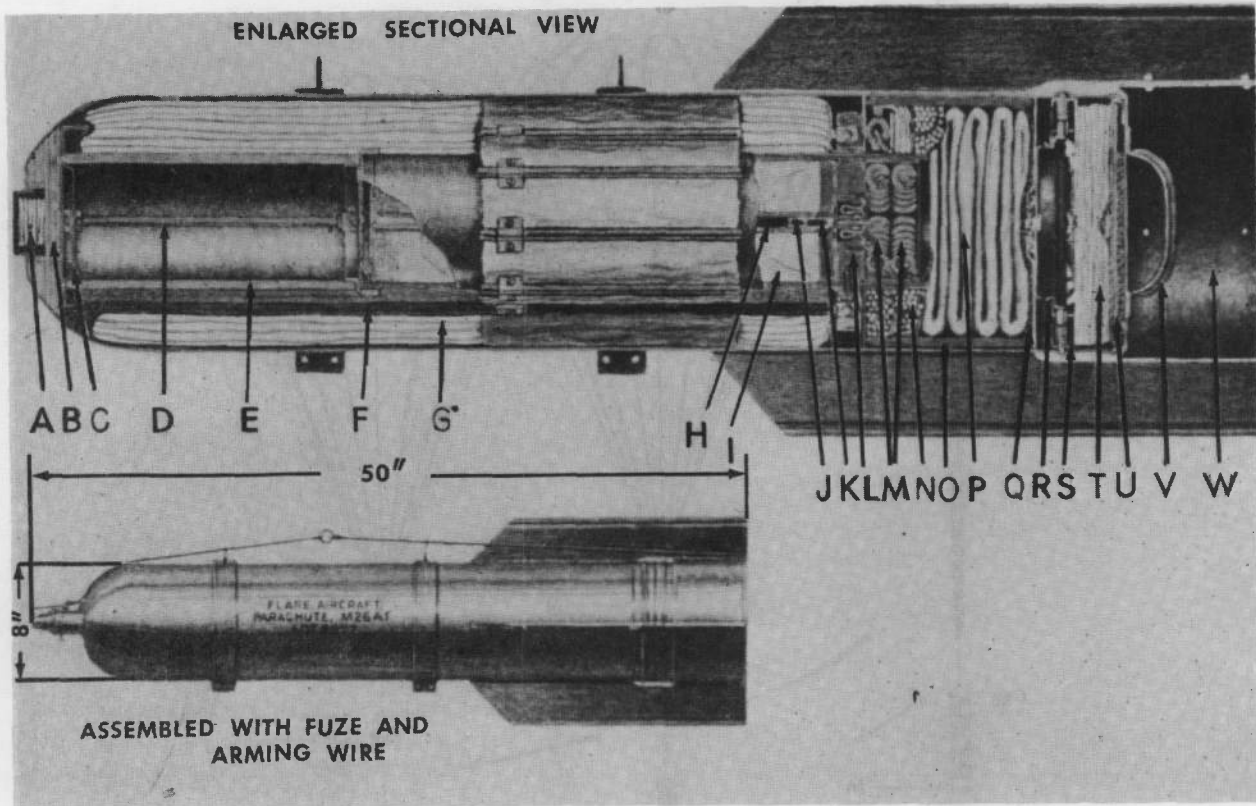

A	Shipping plug	I	Flare charge	Q	Releasing cup disk
B	Shade retainer support	J	Relay charge	R	Cover releasing cup
C	Rib retainer	K	Delay element	S	Cover
D	Stem	L	Base black assembly	T	Stabilizing sleeve
E	Lower spacer	M	Shack observer assembly	U	Hongwire
F	Ribs	N	Shrauds	V	Handle assembly
G	Shade	O	Thrust spacer	W	Fin stiffener
H	Quickmatch	P	Parachute		

Figure 6-13. Typical Aircraft Parachute Flare

Since tracer compositions are relatively difficult to ignite, a more easily-ignitable ignition composition is loaded on top of the tracer composition. The ignition composition, which usually contains a binder, along with a thin metal seal, serves to

protect the tracer composition from the effects of moisture. If the brilliant light from the igniter composition dazzles the gunner and betrays the location of the weapon, a so-called "dim igniter"<sup>10</sup> composition may be used.

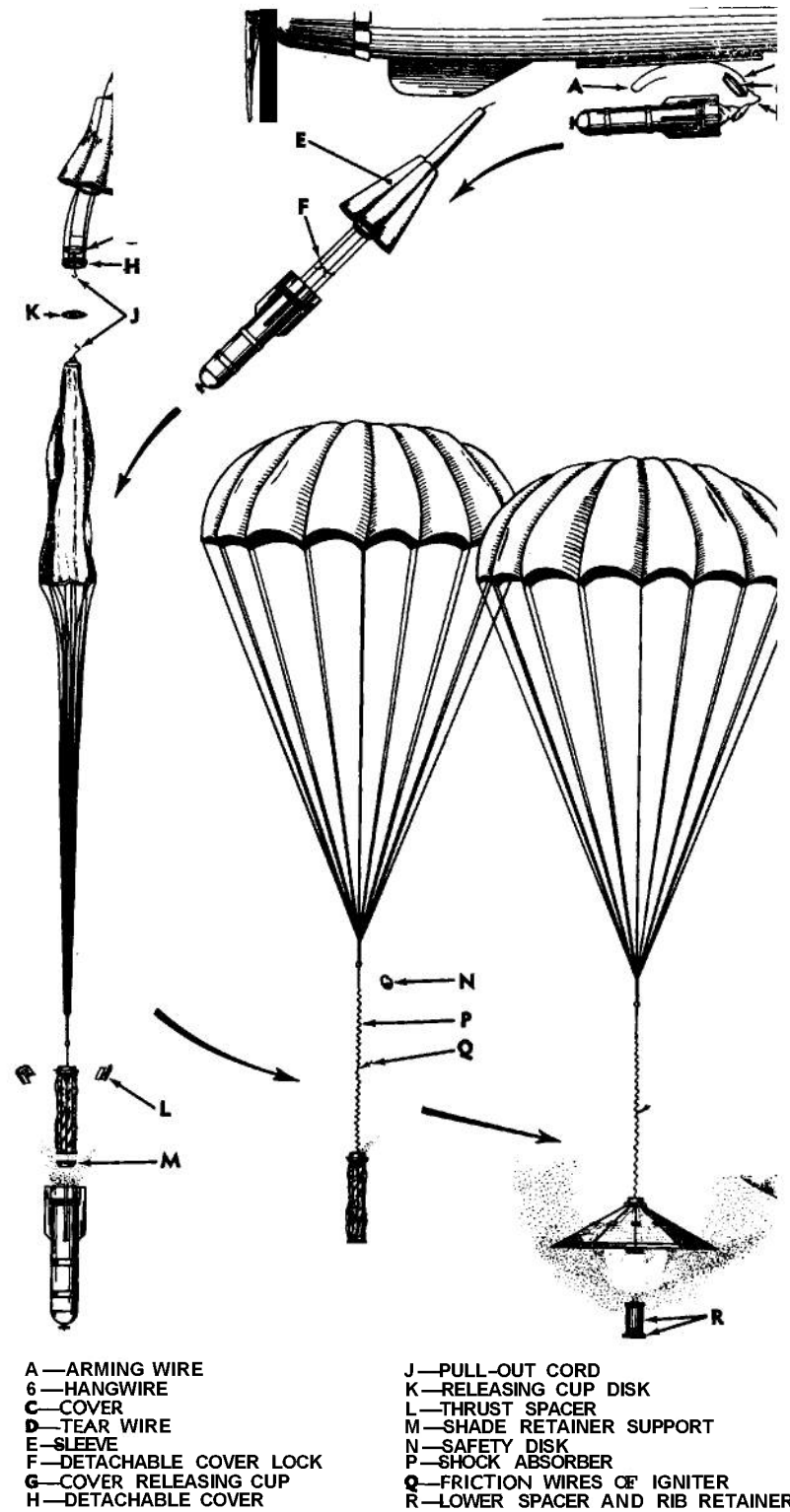

Figure 6-74. Operation of Typical Aircraft Parachute Flare

The pyrotechnic behavior of tracer compositions is similar to that exhibited by other consolidated compositions and the same characteristics are important. Tracer pyrotechnic composi-

tions should, in general: (1) produce maximum light output and saturated color for maximum visibility, (2) burn long enough to permit the projectile to be followed to the target, and (3)

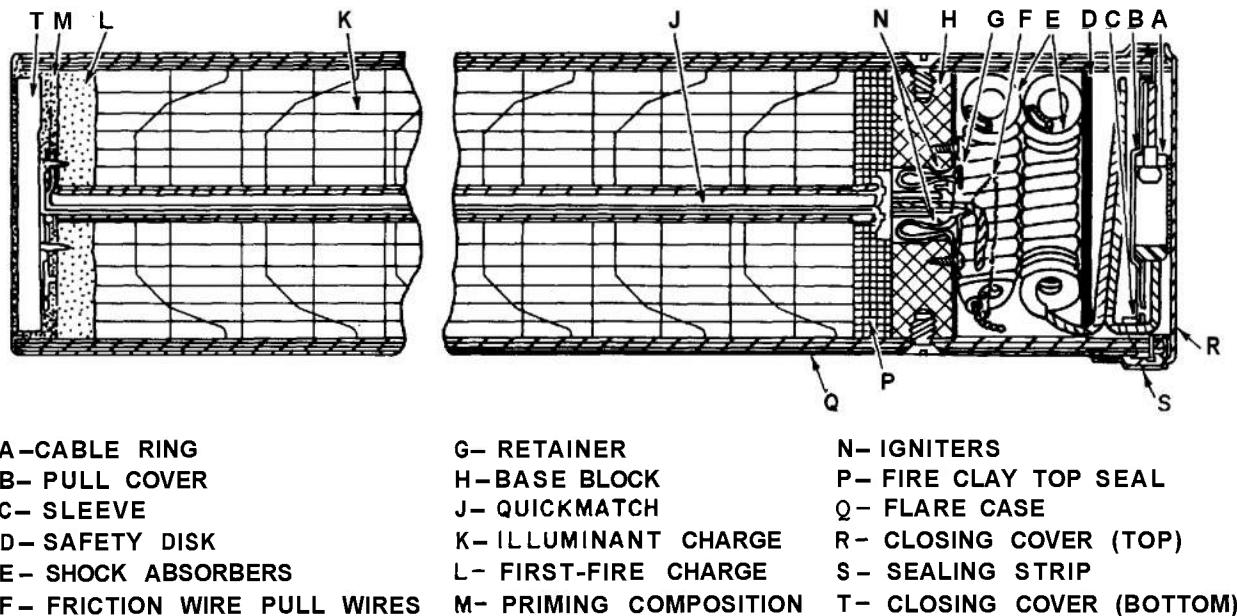

Figure 6-75. Typical Aircraft Tow Target Flare

ignite easily from the igniter composition but resist ignition by any propellant gas which may penetrate to the tracer composition. Most tracers are made to produce red light because red light is the most visible color under daylight conditions; however, wide use of white tracers had also been made by the Germans and Japanese. At times there may be requirements for several different colors to indicate origin of the projectiles.

Smoke tracers (Paragraph 7-1.3) have been proposed and developed to provide a more visible trace in daylight; however, the advantages do not justify providing two types of ammunition with different tracers.

### 6-3.4 TYPICAL COMPOSITIONS

Pyrotechnic illuminating compositions, like other pyrotechnic compositions, are basically a mixture of an oxidizing agent and a metal fuel. Other materials are added to this mixture to modify the burning rate, color, and radiant output, as well as to increase handling safety. Important additives include:

(1) Color intensifiers which are mainly highly chlorinated organic compounds, e.g., hexachloroethane ( $C_2Cl_6$ ), hexachlorobenzene ( $C_6Cl_6$ ), Dodechlorane ( $C_{10}Cl_{12}$ ), and polyvinylchloride ( $CH_2-CHCl$ ).

(2) Binders which include resins, waxes, elastomers, plastics, and oils.

(3) Waterproofing agents which usually are resins, waxes, plastics, oils, and dichromating solutions. (They are used as protective coatings on metals such as magnesium to reduce the amount of reaction with atmospheric moisture.)

(4) Retardants which are usually inorganic salts, plastics, resins, waxes, and oils. (They are used to decrease the rate of the reaction between the fuel and the oxidant so as to obtain the desired overall burning rate.) Some retardants behave merely as inert diluents while others participate in the reaction at much slower rates than the main constituents.

Typical illuminating, signaling, and tracer compositions are given in Tables 6-5(A) and 6-5(B).

### 6-3.5 FACTORS AFFECTING PERFORMANCE

As indicated in Figure 6-22, three zones are established when a consolidated illuminating composition is ignited and burns propagatively. In Zone A, essentially the burning surface, both exothermal and endothermal reactions take place resulting in the formation of gaseous fuel and oxidizer intermediates. These intermediates react exothermally in the flame zone. Usually, the pyro-

CHARACTERISTICS OF VARIOUS AIRCRAFT SIGNAL FLARES

Item	Method of actuation	Time lapse from actuation to full function, sec	Burning time, sec	Candlepower, 10 <sup>5</sup>	Fall, fps	Max L, an.	Max dia, an.	Weight, lb
<b>SIGNAL ILLUMINATION, AIRCRAFT:</b>								
Double star: Red-red, AN-M37 Red-red, AN-M37A1 Red-red, AN-M37A2	Fired from PISTOL, pyrotechnic, AN-M8	5 ..... 5	10±3	25 (ea star)	Free	3.85	1.54 1.57 1.57	0.35
Yellow-yellow, AN-M38 Yellow-yellow, AN-M38A1 Yellow-yellow, AN-M38A2	or PROJECTOR, pyrotechnic, hand, M9	..... ..... 5	10±3	12 (ea star) 20 (ea star) 20 (ea star)	Free	3.85	1.54 1.57 1.57	0.42 0.35 0.35
Green-green, AN-M39 Green-green, AN-M39A1 Green-green, AN-M39A2	.....	..... ..... 5	10±3	20 (ea star)	Free	3.85	1.54 1.57 1.57	0.35 0.39 0.39
Red-yellow, AN-M40 Red-yellow, AN-M40A1 Red-yellow, AN-M40A2	Fired from PISTOL pyrotechnic, AN-M8	..... ..... 5	10±3	25 (R star) 12 (Y star) 25 (R star) 20 (Y star) 25 (R star) 20 (Y star)	Free	3.85	1.54 1.57 1.57	0.39 0.35 0.35
Red-green, AN-M41 Red-green, AN-M41A1 Red-green, AN-M41A2	or PROJECTOR, pyrotechnic, hand, M9	..... ..... 5	10±3	25 (R star) 20 (G star)	Free	3.85	1.54 1.57 1.57	0.35 0.39 0.39
Single star: Red, AN-M43 Red, AN-M43A1 Red, AN-M43A2	.....	..... ..... 5	10±3	25	Free	3.85	1.54 1.57 1.57	0.27
Yellow, AN-M44 Yellow, AN-M44A1 Yellow, AN-M44A2	.....	0 ..... 5	10±3	15 25 25	Free	3.85	1.54 1.57 1.57	0.26
Green, AN-M45 Green, AN-M45A1 Green, AN-M45A2	.....	..... ..... 5	10±3	30 25 25	Free	3.85	1.54 1.57 1.57	0.32
Tracer, double star: Yellow tracer, red-yellow star, AN-M53 Yellow tracer, red-yellow star, AN-M53A1 Yellow tracer, red-yellow star, AN-M53A2 Green tracer, red-red star, AN-M54 Green tracer, red-red star, AN-M54A1 Green tracer, red-red star, AN-M54A2	.....	0 ..... 5 ..... 0 5 ..... 0 5	T, 2.5 to 4 Star, 3 to 4.5 3 to 4.5	T, 30 R star, 48 Y star, 36 R star, 48 Y star, 36 T, 25 Star, ea 48 Star, ea 48	Free ..... Free	3.85 ..... 3.85	1.57 ..... 1.57	0.40 ..... 0.38
Green tracer, green-red star, AN-M55 Green tracer, green-red star, AN-M55A1 Green tracer, green-red star, AN-M55A2	.....	0 ..... 5	T, 2.5 to 4 Star, 3 to 4.5 3 to 4.5	T, 25 G star, 20 R star, 48 G star, 20 R star, 48	Free	3.85	1.57	0.38

<i>Item</i>	<i>Method of actuation</i>	<i>Timelapse from actuation to full function, sec</i>	<i>Burning time, sec</i>	<i>Candlepower, 103</i>	<i>Fall, fps</i>	<i>Max L, an.</i>	<i>Max dia, in.</i>	<i>Weight, lb</i>
Red tracer, green-green star, AN-M56 Red tracer, green-green star, AN-M56A1 Red tracer, green-green star, AN-M56A2	Fired from PISTOL, pyrotechnic, AN-M8 or PROJECTOR, pyrotechnic, hand, M9	0	T, 2.5 to 4	T, 30	Free	3.85	1.57	0.38
5		Star, 3 to 4.5	Star, ea 20					
5		3 to 4.5	Star, ea 20					
Red tracer, red-red star, AN-M57 Red tracer, red-red star, AN-M57A1 Red tracer, red-red star, AN-M57A2	Fired from PISTOL, pyrotechnic, AN-M8 or PROJECTOR, pyrotechnic, hand, M9	0	3 to 4.5	Star, ea 48	Free	3.85	1.57	0.39
5		3 to 4.5	Star, ea 48					
5		3 to 4.5	Star, ea 48					
Red tracer, green-red star, AN-M58 Red tracer, green-red star, AN-M58A1 Red tracer, green-red star, AN-M58A2	Fired from PISTOL, pyrotechnic, AN-M8 or PROJECTOR, pyrotechnic, hand, M9	0	3 to 4.5	G star, 28	Free	3.85	1.57	0.39
5		3 to 4.5	R star, 48					
5		3 to 4.5	R star, 48					

technic composition is fuel rich and the excess fuel\* reacts with oxygen from the atmosphere. Some of the energy required to form these gaseous intermediates results from the energy released in exothermic reactions on the burning surface (Zone A) and some from the flame zone. Energy from Zone A is also transferred to Zone B which may be considered the pre-ignition zone. Directly below Zone B is the remainder of the unreacted pyrotechnic composition, or Zone C.

Figure 6-23 shows a typical isothermal diagram of the temperature distribution of a pyrotechnic flame.<sup>8</sup> The temperature is not constant throughout the flame, the hottest portion occurring approximately two inches above the burning surface in the middle of the flame.

The flame produced by most pyrotechnic compositions is heterogeneous in nature, containing solid, liquid, and gaseous products of combustion. As most of the radiation produced is of thermal origin,<sup>8</sup> the distribution of radiation in any spectral region is determined, basically, by the chemical nature and physical state of the products which emit in that region and the temperature reached

\* See example Paragraph 3-2.5.

by these emitting species. The rate at which a pyrotechnic mixture burns depends on the amount and rate at which heat is evolved. Sufficient heat must be produced to raise the temperature of the ingredients to a point at which an exothermal reaction will be initiated, and the reaction rate must be sufficient to more than compensate for heat losses in order for the composition to burn propagatively. As are common to all combustion processes, the rate of burning, the products formed, and the flame temperature are affected markedly by the composition of the mixture, as well as by the physical condition of the materials and the ambient conditions under which it is burned. Some of the more important factors which affect the performance of light-producing pyrotechnic items include: (1) heat of reaction, (2) composition, (3) emitters, (4) color intensifiers, (5) binders, (6) particle size and distribution, (7) consolidation, (8) flare diameter, (9) case materials and coating, (10) temperature and pressure, (11) rotational spin, and (12) moisture. In addition to the above factors, the igniter or first fire used may also influence the output of a pyrotechnic device. Any changes in the pyrotechnic composition, the



**TABLE 6-4(B)**  
**CHARACTERISTICS OF VARIOUS GROUND SIGNAL FLARES**

<i>Item</i>	<i>Method of actuation</i>	<i>Time lapse from actuation to full function, sec</i>	<i>Burning time, sec</i>	<i>Candlepower, 103</i>	<i>Fall, fps</i>	<i>Max L, an.</i>	<i>Max dia, lb</i>	<i>Weight, an.</i>
<b>SIGNAL, ILLUMINATION, GROUND:</b> White star, cluster, M18A1 White star, cluster, M18A2	Fired from LAUNCHER, grenade, M7 series	5.5	4 to 10	18 (for ea of 5 stars)	Free	10.14	1.88	1.09
Green star, cluster, M20A1 Green star, cluster, M20A2		5.5	4 to 10	7 (for ea of 5 stars)	Free	10.14	1.88	1.09
Amber star, cluster, M22A1 Amber star, cluster, M22A2		5.5	4 to 10	2 (for ea of 5 stars)	Free	10.14	1.88	1.06
Red star, cluster, M52A1		5.5	4 to 10	35 (for ea of 5 stars)	Free	10.14	1.88	1.09
Red star, cluster, M52A2		.....	.....					
Green star, cluster, M125 (T71)	Hand-held rocket-propelled launching mechanism	5.0	4 to 8	9 (for ea of 5 stars)	4.5	10.14	1.64	1.3
White star, parachute, M17A1	Fired from LAUNCHER, grenade, M7 series	5.5	20 to 30	20	7	10.40	1.88	1.04
White star, parachute, M17A2		.....						
Green star, parachute, M19A1		5.5	20 to 30	20	7	10.40	1.88	1.02
Green star, parachute, M19A2		.....						
Amber star, parachute, M21A1		5.5	20 to 30	4	7	10.40	1.88	1.00
Amber star, parachute, M21A2		.....						
Red star, parachute, M51A1	5.5	20 to 30	20	7	10.40	1.88	1.02	
Red star, parachute, M51A2	.....							
Red star, parachute, M126 (T72)	Hand-held rocket-propelled type launching mechanism	5.0	50	5	8	9.64	1.64	.....
White star, parachute, M127 (T73)			25	50	10-1	9.64	1.64	1.3
Red star, parachute, M131 (T66E1)			30	10	.....	10.0	1.63	1.21

igniter, the container, etc.—which might be caused by storage conditions—may also markedly affect the output of light-producing pyrotechnics.

### 6-3.5.1 Heat of Reaction

One of the important factors in determining the luminous intensity of a light-producing pyrotechnic device is the temperature reached by the emitting species in the flame and produced by the burning of the pyrotechnic mixture. The temperature reached depends, in turn, on the amount and rate at which energy is released by the reaction. In general, therefore, the energy released during

combustion should be high and products formed must be stable at the high temperatures necessary to produce the luminous intensity required for illuminating and signaling purposes.

The heats of reaction for the stoichiometric reaction between several oxidizers, and aluminum or magnesium as the fuel, are summarized in Tables 6-6 and 6-7. In general, for both fuels, the perchlorate oxidizers are the best solid energy producers on either a weight or volume basis; however, some of the nitrates are almost as good. Physical data and burning characteristics of stoichiometric mixtures of the alkali and alkaline-

Figure 6-16. Typical Surface Trip Flare

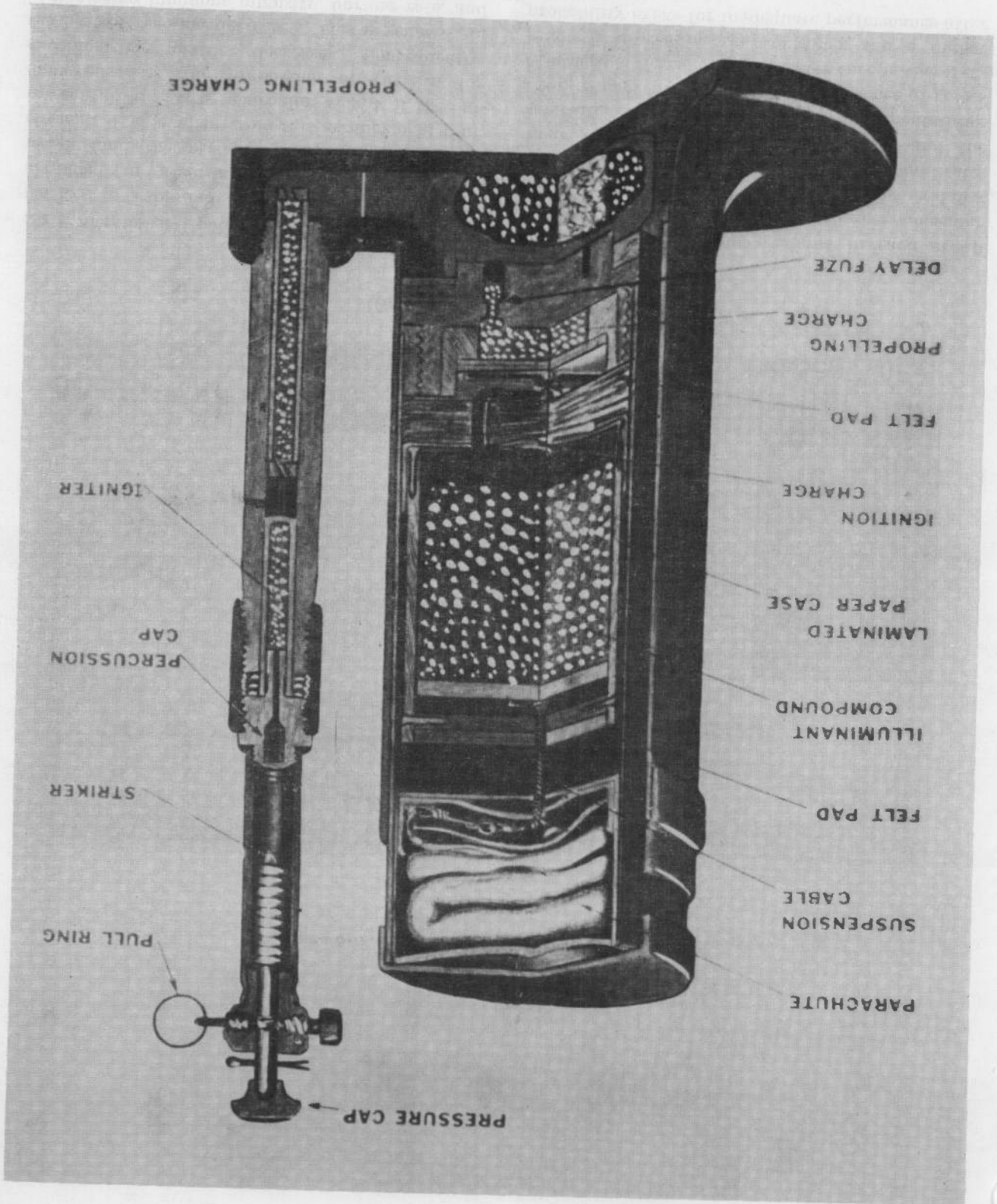

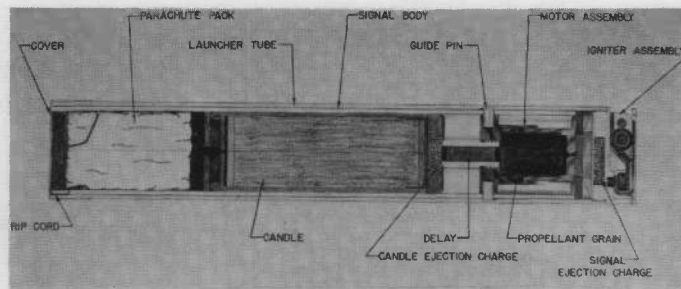

Figure 6-17. Typical Hand-Held Illuminating Signal

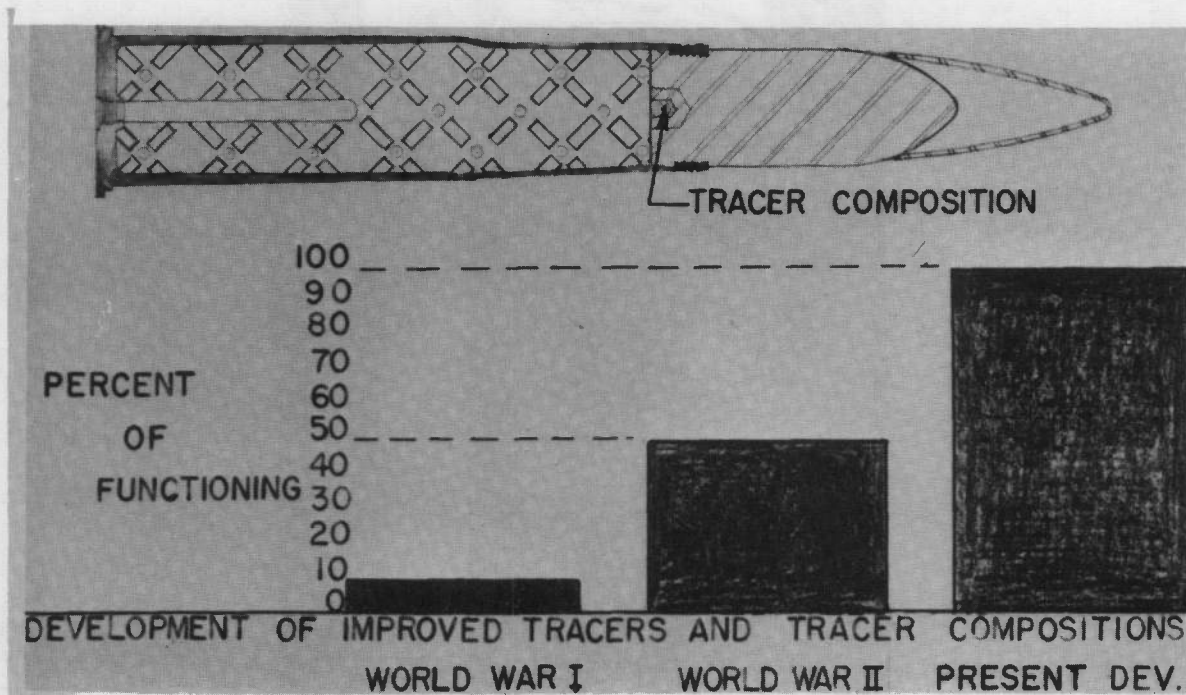

Figure 6-18. Small Arms Tracer

earth nitrates and potassium perchlorate are summarized in Table 6-8(A). The nitrates have been arranged in accordance with their molecular weight and the periodic group of the metallic element. It is evident from this arrangement that, in each group, as the molecular weight of the oxidant increases, the proportion of fuel in the stoichiometric mixture decreases. Consequently, the heat of reaction decreases. This is reflected in a decreasing luminous intensity, burning rate, and efficiency. On this basis, it would appear that the

lower molecular weight oxidants in each group should be preferred over those of higher molecular weight. Unfortunately, the lower weight oxidants tend to be extremely hygroscopic, which complicates their use in pyrotechnic compositions, and the shelf-life or the stability of mixtures containing them is markedly reduced in the presence of traces of atmospheric moisture. Greater care is therefore required in sealing the container and a higher probability exists for inadequate performance after long storage.

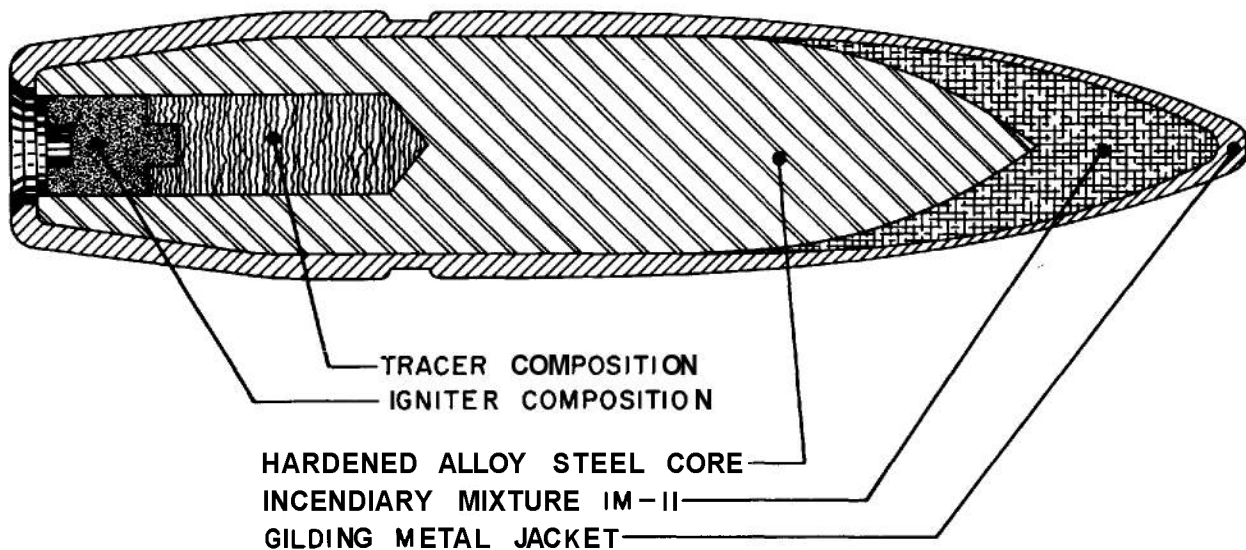

Figure 6-79. Armor-Piercing Tracer

### 63.5.2 Composition

The luminous intensities of flares containing binary mixtures of magnesium and the oxidizers listed in Table 6-8(B), change with increasing magnesium as shown in Figure 6-24. For a given oxidizer, the luminous intensity increases with the amount of magnesium until a maximum is reached at 70 to 80 percent magnesium. A further increase in the amount of magnesium results in a reduction in luminous intensity. The burning rate also is a maximum at 70 to 80 percent magnesium, as is illustrated in Figure 6-25.

As seen in Example 5, Paragraph 3-2.5, the amount of magnesium which will produce the maximum luminous intensity can be estimated if it is assumed that only that amount of magnesium, in excess of the stoichiometric amount, which can be vaporized by the stoichiometric reaction will react with the oxygen in the air. It requires about 1.5 kilocalories to vaporize one gram of magnesium; therefore, the amount of energy released by one gram of a stoichiometric mixture of magnesium and sodium nitrate will vaporize about 1.3 grams of magnesium. This corresponds to a mixture containing about 75 percent magnesium.

### 63.5.3 Emitters

As shown in Figure 6-24, the light intensity at the optimum magnesium content varies with the

oxidizer used, ranging from about 10,000 candles per square inch for potassium nitrate to around 800,000 candles per square inch with sodium nitrate as the oxidizer. The difference is due to several factors, one of the more important of which is the metal in the oxidant. Sodium is a strong emitter in the visible region while potassium is not.

The elements used to color pyrotechnic flames for military uses are strontium, producing red; barium, producing green; and sodium, producing yellow. Copper (blue or green) has also been used.<sup>22</sup> Lithium (red), boron (green), thallium (green), rubidium (red), and cesium (blue), are also strong color producers, but their use is not practical because of cost, toxicity, or nature of their compounds.<sup>36</sup>

The chromaticity coordinates for a large number of yellow (sodium containing), green (barium containing), and red (strontium containing) flares, when plotted on a chromaticity diagram, form three straight lines which converge toward a common point, as shown in Figure 6-26.<sup>37</sup>

The dominant wavelength for the yellow flares (indicated by the intersection of the straight line with the perimeter of the chromaticity diagram) is around 590 millimicrons. Results of some yellow flares did not, as indicated in Figure 6-26, fall on the straight line. This is believed to be due

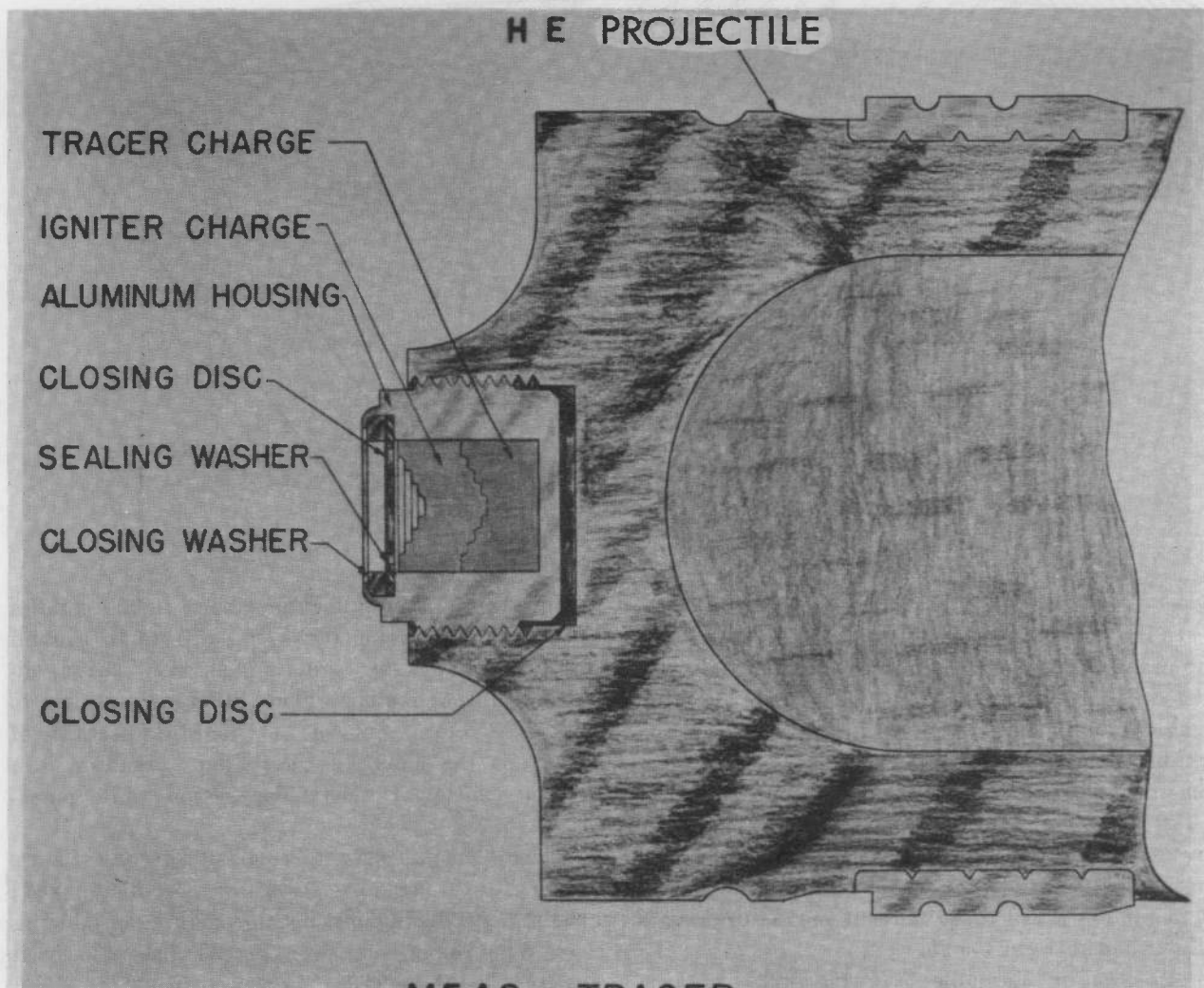

Figure 6-20. Artillery Tracer Element in Projectile

to measurement error as later measurements of flares with essentially the same composition fell close to the straight line. For the red flare and green flare, both of which contain a source of chlorine, the dominant wavelengths are approximately 640 millimicrons and approximately 524 millimicrons, respectively. Typical spectra obtained for a red, yellow, and green signal flare are given in Figure 6-27.

Spectroscopic studies indicate that most of the light produced by illumination and signal flares is due to a limited number of monatomic,

diatomic, and possibly triatomic emitters which can exist at the high temperatures in a pyrotechnic flame.<sup>38</sup> Secondary emitters, including particulate matter, will influence the dominant wavelength, the colorimetric purity, the saturation, and the relative intensity of the light produced. These spectroscopic studies indicated that the red light produced by flares containing strontium and a source of chlorine is due to the diatomic molecule  $\text{SrCl}$  which emits strongly near 640 millimicrons. For flares which did not contain chlorine, but produce a red light, it was concluded that

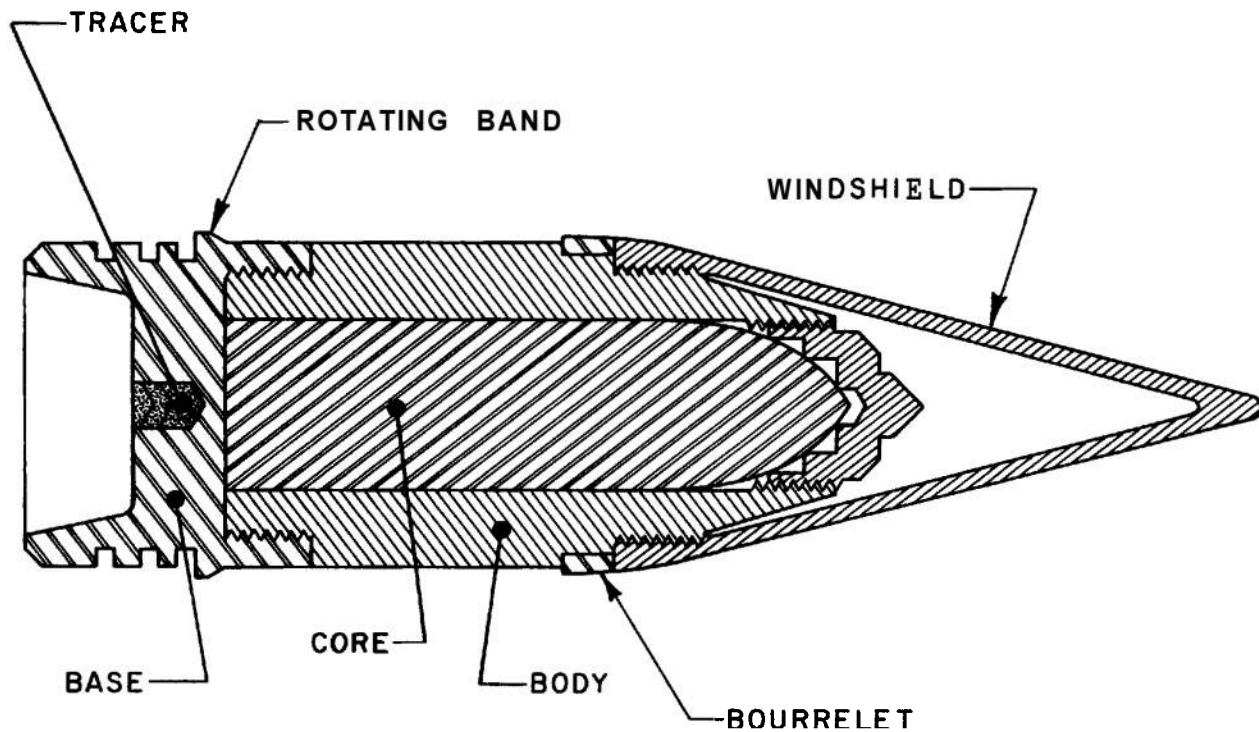

Figure 6-21. Artillery Tracer

the red light was, most likely, due to strontium oxide ( $\text{SrO}$ ).

Green flames are produced by the band system of barium chloride ( $\text{BaCl}$ ) in the 505- to 535-millimicron region of the spectrum. Most green flames show, in addition to the band emission from barium chloride, emission in the orange and red region, band emission from calcium chloride ( $\text{CaCl}$ ) and strontium chloride ( $\text{SrCl}$ ) formed from strontium and calcium impurities in the barium. In addition, there are contributions from an extensive barium oxide ( $\text{BaO}$ ) band system (400 to 800 millimicrons).

Other studies indicate that the triatomic molecule  $\text{Sr}(\text{OH})$  (strong emission near 640 millimicrons) may contribute to the production of red light and that barium hydroxide  $\text{Ba}(\text{OH})$  (strong emission from 487 to 527 millimicrons) may contribute to the production of green light. There is some evidence that part of the radiation from the emitter may be due to chemiluminescence.<sup>22</sup>

Blue flames are normally produced by the

emission of cuprous chloride ( $\text{CuCl}$ ), much of which is radiated in the 420- to 460-millimicron region of the spectrum. The blue-green and green systems which are also produced are usually much weaker.

Yellow light is primarily due to the D lines of sodium and associated continuum. At high sodium concentrations, there is strong continuous emission in a region which extends from 500 to 700 millimicrons.

As shown in Figure 6-28, which is the spectral distribution of energy from a green flare,<sup>39</sup> the specific emission, approximately 525 millimicrons, is superimposed on a continuous background.<sup>40</sup> This results in a less saturated green. An increase in magnesium content, as shown in Figure 6-29 for a yellow flare,<sup>37</sup> results in a decreased saturation of the colored light produced. The continuous background may be due, in part, to incandescent carbon (from binder) as a binary mixture of magnesium and an oxidizer show somewhat less continuous background. It is also due, in part, in

**TABLE 6-5  
TYPICAL ILLUMINATING, SIGNALING, AND TRACER COMPOSITIONS**

SOURCE	COLOR	FUEL			OXIDIZERS					Binder			
		Magnesium	Aluminum	Misc.	Barium Nitrate	Sodium Oxalate	Sodium Nitrate	Strontium Nitrate	Misc.	Oil Linseed /Castor	Wax Paraffin	Misc.	
A	White	26.9			38.3					25.2(d)	2.9	6.7	
A	White	28.5	6.5		37.0							8.0	
A	White	36	4		43	12.5					1	2.5	
A	White	48			21	5	21				1	3	
C	Yellow	52									1		13(i)
C	Yellow	58					35						5(k)
C	Green	23			53								0.5(l)
C	Red	40						18		22(e)			2(m)
C	Red												20(n)
D	Red		21		68	5					2		2(o)
D		58.0					37.5						6(n)
													7(o)
													4(p)
													4.5(s)
												(29)(k)	
B	Red	26.7						33.3		26.7(f)			6.7(q)
B	Red	28						55		5(g)			1.6(q)
B	Red	26						52					17(r)
D	Dark				90(a)								16(r)
D	Dark				10(a)								
D	Dark				34(b)					28(h)			
D	Dark				20(c)	50				38(i)			15(t)
													5(u)

TABLE 6-6  
HEATS OF REACTION OF ALUMINUM WITH  
STOICHIOMETRIC QUANTITIES OF VARIOUS OXIDANTS

<i>Oxidant</i>	<i>Composition Density, g/cc*</i>	<i>Heat of Reaction</i>			<i>Products Assumed</i>
		<i>Kcal, Total</i>	<i>Cal/g Comp</i>	<i>Cal/cc Comp*</i>	
Al(ClO <sub>4</sub> ) <sub>3</sub>	2.70 est	1,603 est	2,960 est	7,990 est	Al <sub>2</sub> O <sub>3</sub> -AlCl <sub>3</sub>
Mg(ClO <sub>4</sub> ) <sub>2</sub>	2.64	3,230	2,930	7,750	Al <sub>2</sub> O <sub>3</sub> -MgCl <sub>2</sub>
LiClO <sub>4</sub>	2.53	1,590	2,970	7,520	Al <sub>2</sub> O <sub>3</sub> -LiCl
Be(ClO <sub>4</sub> ) <sub>2</sub>	2.38 est	3,200 est	3,030 est	7,220 est	Al <sub>2</sub> O <sub>3</sub> -BeCl <sub>2</sub>
KClO <sub>4</sub>	2.58	1,598	2,530	6,540	Al <sub>2</sub> O <sub>3</sub> -KCl
Be(NO <sub>3</sub> ) <sub>2</sub>	2.51 est	1,880 est	2,810 est	7,070 est	Al <sub>2</sub> O <sub>3</sub> -BeO-N <sub>2</sub>
Pb(NO <sub>3</sub> ) <sub>2</sub>	3.90	691	1,585	6,190	Al <sub>2</sub> O <sub>3</sub> -Pb-N <sub>2</sub>
NaNO <sub>3</sub>	2.39	1,624	2,080	4,980	Al <sub>2</sub> O <sub>3</sub> -Na <sub>2</sub> O-N <sub>2</sub>
F <sub>2</sub> O (liq)	1.95	1,038	3,850	7,510	Al <sub>2</sub> O <sub>3</sub> -AlF <sub>3</sub>
O <sub>2</sub> (liq)	1.64	798	3,910	6,430	Al <sub>2</sub> O <sub>3</sub>
F <sub>2</sub> (liq)	1.37	622	3,700	5,070	AlF <sub>3</sub>
CuO	5.11	288	984	5,030	Al <sub>2</sub> O <sub>3</sub> -Cu
MeO <sub>3</sub>	3.81	219	1,105	4,210	Al <sub>2</sub> O <sub>3</sub> Me
Fe <sub>2</sub> O <sub>3</sub>	4.18	203	948	3,960	Al <sub>2</sub> O <sub>3</sub> -Fe
WO <sub>3</sub>	5.46	198	693	3,780	Al <sub>2</sub> O <sub>3</sub> -W
V <sub>2</sub> O <sub>5</sub>	3.19	876	1,075	3,340	Al <sub>2</sub> O <sub>3</sub> -V
H <sub>2</sub> O (liq)	1.46	194	1,800	2,620	Al <sub>2</sub> O <sub>3</sub> -H <sub>2</sub>

\* Based on calculated true density.

the visible, to the volume emission resulting from scattering by the solid particles of MgO which are essentially transparent in that environment.

White light can be produced by : (1) developing an extensive continuum, (2) exciting an extensive discrete band system, and (3) exciting two nearly complementary band systems. The light produced by incandescent carbon particles, or the extensive sodium continuum produced by the magnesium-sodium nitrate illuminating flare, are good examples of method (1). The extensive band system of barium oxide (BaO) (400 to 800 millimicrons) is an example of method (2). Suitable blending of the emission from strontium chloride (SrCl) (red), calcium chloride (CaCl<sub>2</sub>) (yellow), and barium chloride (BaCl<sub>2</sub>) (green) is an example of method (3).

### 6-3.5.4 Color Intensifiers

Highly chlorinated organic compounds such as hexachloroethane, hexachlorobenzene, polyvinyl-

chloride, or Dechlorane are generally used as color intensifiers because they are a ready source of chlorine. As shown in Figure 6-30, the addition of increasing amounts of polyvinylchloride reduces the candlepower of a magnesium-strontium nitrate flare; however, its color value (see Paragraph 6-2.5.5) as a red flare increases as shown in Figure 6-31. Red color values of greater than 0.40 are impossible to obtain unless the color intensifier or binder is a chlorine containing compound. As already indicated, in the absence of a chlorine compound, the red color may be due to strontium oxide while, in the presence of chlorine, strontium chloride appears to be the emitting species.<sup>35</sup>

The production of a saturated green light by pyrotechnic means is more difficult than production of a red light of relatively high saturation. In most pyrotechnic items, the production of green light appears to depend on the green emitter, barium chloride, formed from the decomposition



**TABLE 6-7**  
**HEATS OF REACTION OF MAGNESIUM WITH**  
**STOICHIOMETRIC QUANTITIES OF VARIOUS OXIDANTS**

<i>Oxidant</i>	<i>Composition</i> <i>Density, g/cc*</i>	<i>Heat of Reaction</i>			<i>Products</i> <i>Assumed</i>
		<i>Kcal, Total</i>	<i>Cal/g Comp</i>	<i>Cal/cc Comp*</i>	
Al(ClO <sub>4</sub> ) <sub>3</sub>	2.14 est	1,732 est	2,810 est	6,010 est	MgO-AlCl <sub>3</sub>
Mg(ClO <sub>4</sub> ) <sub>2</sub>	2.11	1,163	2,785	5,880	MgO-MgCl <sub>2</sub>
LiClO <sub>4</sub>	2.04	573	2,810	5,740	MgO-LiCl
NaClO <sub>4</sub>	2.10 est	581	2,650	5,560 est	MgO-NaCl
KClO <sub>4</sub>	2.13	576	2,440	5,200	MgO-KCl
Be(NO <sub>3</sub> ) <sub>2</sub>	2.04 est	681 est	2,675 est	5,420 est	MgO-BeO-N <sub>2</sub>
AgNO <sub>3</sub>	3.00	804	1,656	4,970	MgO-Ag-N <sub>2</sub>
LiNO <sub>3</sub>	2.03	631	2,430	4,940	MgO-Li <sub>2</sub> O-N <sub>2</sub>
Pb(NO <sub>3</sub> ) <sub>2</sub>	3.03	756	1,584	4,800	MgO-Pb-N <sub>2</sub>
Ca(NO <sub>3</sub> ) <sub>2</sub>	2.04	647	2,265	4,620	MgO-CaO-N <sub>2</sub>
Sr(NO <sub>3</sub> ) <sub>2</sub>	2.38	627	1,880	4,480	MgO-SrO-N <sub>2</sub>
NaN <sub>3</sub>	2.00	594	2,035	4,070	MgO-Na <sub>2</sub> O-N <sub>2</sub>
Ba(NO <sub>3</sub> ) <sub>2</sub>	2.54	616	1,610	4,080	MgO-BaO-N <sub>2</sub>
KNO <sub>3</sub>	1.95	570	1,760	3,430	MgO-K <sub>2</sub> O-N <sub>2</sub>
F <sub>2</sub> (liq)	1.29	264	4,230	5,460	MgF <sub>2</sub>
O <sub>2</sub> (liq)	1.44	288	3,570	5,140	MgO
PbO <sub>2</sub>	5.37	222	770	4,140	MgO-Pb
BaO <sub>2</sub>	3.53	137	630	2,220	MgO-Ba

\* Based on calculated true density.

products of barium nitrate and an organic chlorine containing compound.

Magnesium also combines readily with chlorine and, therefore, will compete with the barium for the available chlorine. There is also competition between chlorine and oxygen for the barium. To select the best chlorine donor (Cl<sub>2</sub> is ideal but too difficult to handle), several compositions were tested which contained organic chlorides having different percentages of chlorine. These compounds lowered the candlepower, with generally improved color, and increased the amount of barium chloride formed. The best results were obtained with a composition containing 40 percent magnesium, 45 percent barium chlorate, 10 percent polyvinylidene-chloride, and 5 percent Laminae. The chlorine-to-barium ratio was 3.48 to 1.0; the magnesium-to-barium ratio was 11.8 to 1.0, and the chlorine-(available to barium)-to-barium ratio was 0.272 to 1.0. All other chlorine containing additives im-

proved the green color, but to a lesser degree. Ethylcellulose, the one nonchlorinated organic additive tested, improved the color of the flare slightly as a larger percentage of it was used. This slight improvement in color is believed to be due to the decrease in luminous intensity. The improvement in color of the compositions containing chlorinated organic additives resulted from an increase in the amount of barium chloride formed as well as from decreased luminous output.

It has also been suggested that the addition of a chlorine containing compound to a flare mixture may, by shift of equilibrium, result in the formation of barium hydroxide which emits strongly in the green.<sup>22</sup>

#### 6-3.5.5 Binders

Binding agents—including certain resins, waxes, plastics, and oils—serve multiple purposes in pyrotechnic compositions. They are added to

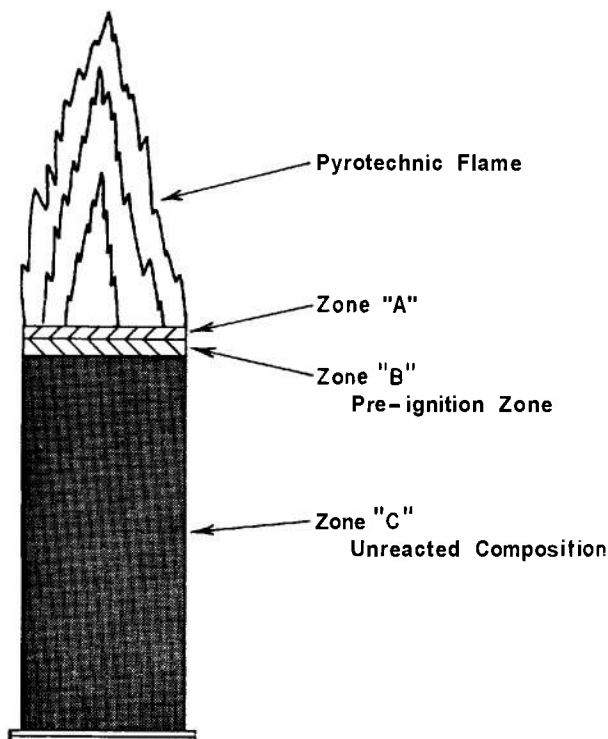

Figure 6-22. Zones in Flame Propagation

prevent segregation and to obtain more uniformly blended compositions. In addition, they serve to make the finely-divided particles of metal and oxidizer adhere to each other and help to obtain maximum density and, therefore, efficiency in burning. Binders also frequently desensitize mixtures which would otherwise be very sensitive to impact, friction, and static electricity and, as binder content is increased, burning rate is decreased and candlepower reduced.

Materials such as linseed oil, used earlier in most standard pyrotechnic compositions as binders, oxidized and hardened during storage causing a change in the burning characteristics. The replacement of linseed oil by Laminae, a polyester resin,<sup>41</sup> greatly reduced this problem.<sup>8</sup> It was found that self-hardening polyester resins tended to minimize the need for high consolidation pressures. Most of the polyester resins used are essentially esters manufactured from glycols and unsaturated acids, and monomeric cross-linking additives such as styrene and diallyl phthalate which are utilized to cure the resin. When the resins are

catalyzed, they undergo a transition from liquid gel to solid as they cure.<sup>42</sup>

The results of a series of tests involving polyester resins, presented in Table 6-9, led to the conclusion that the majority of these resins would be satisfactory and that mixtures containing these materials would be as stable and have the same burning characteristics as mixtures containing Laminae as a binding agent.

The luminous intensity for all mixtures tested, including a binary mixture not containing a binder of any kind, varied greatly during the first month of storage. This strongly indicates that the binder is not the cause of this variation. There is, however, little, if any, change in burning rate associated with this change in luminous intensity.

#### 6-3.5.6 Particle Size

The rate of reaction of a pyrotechnic composition is related to the specific surface of the ingredients. Factors such as size, shape, distribution, and surface of the particles affect the properties of the particulate material and must be accurately controlled. These factors affect the packing properties of the ingredients which, in turn, affect the weight-volume relationship of the particles.

As has been indicated in the discussion of propagative burning (Paragraph 3-3.6), the burning rate and candlepower of a pyrotechnic composition depend on the particle size of the metal powder fuel. This effect is shown in Figures 6-32(A) and 6-32(B), and Table 6-10 for an illuminant mixture containing magnesium, sodium nitrate, polyvinylchloride, and Laminae. A decrease in particle size for the spherical particles results in an increase in the specific surface—the surface area associated with one grain of powder—an increase in the candlepower, and an increase in the burning rate. This is in agreement with the theory presented in Paragraph 3-3.6.

The above results were obtained for compositions in which the magnesium was essentially a sphere; any other particle shape will result in a larger specific surface than that of a comparable sphere. In Table 6-11, the burning characteristics of similar compositions prepared with ground and with atomized magnesium having the same sieve

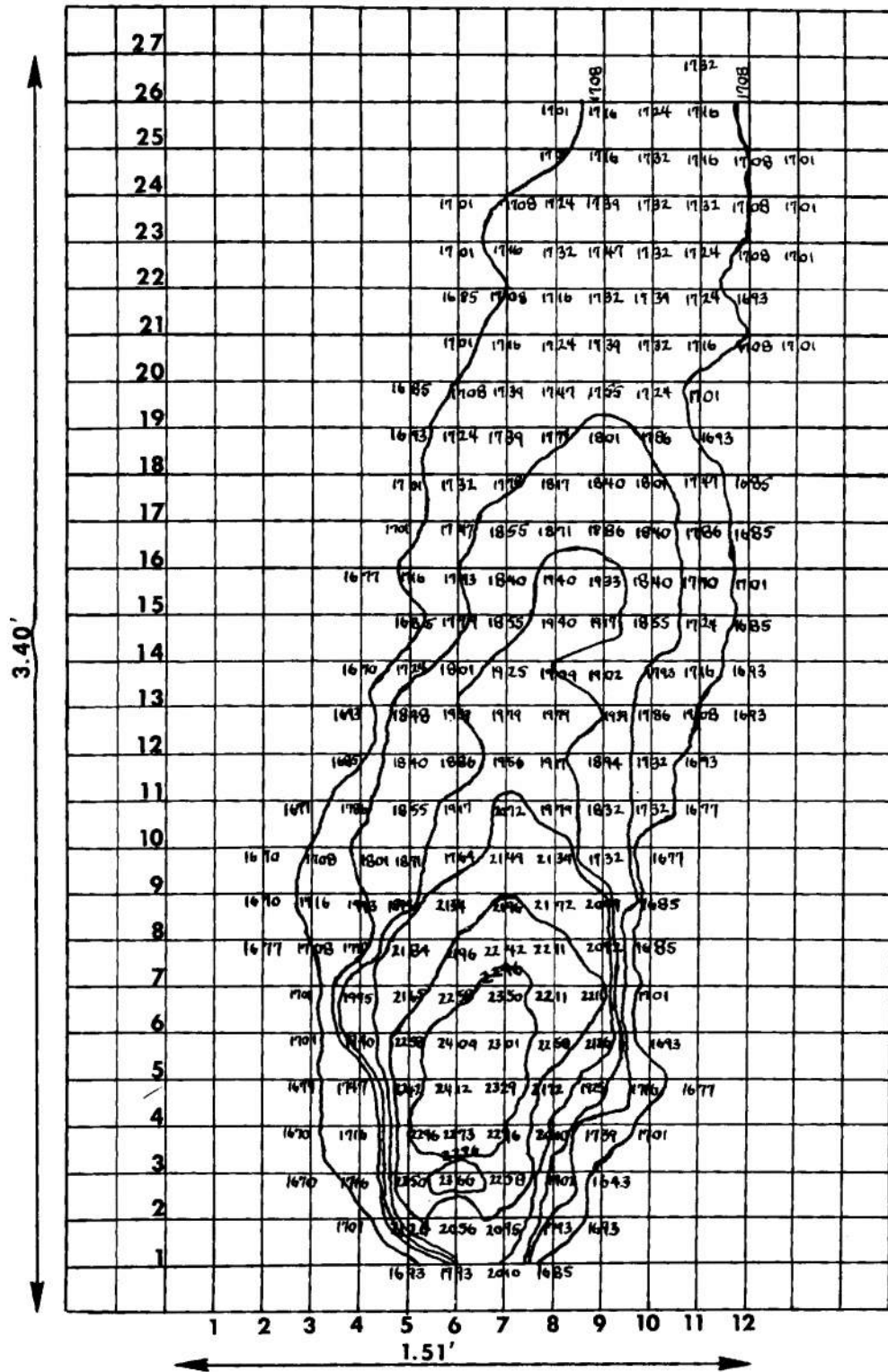

Figure 6-23. Temperature Distribution in a Pyrotechnic Flame

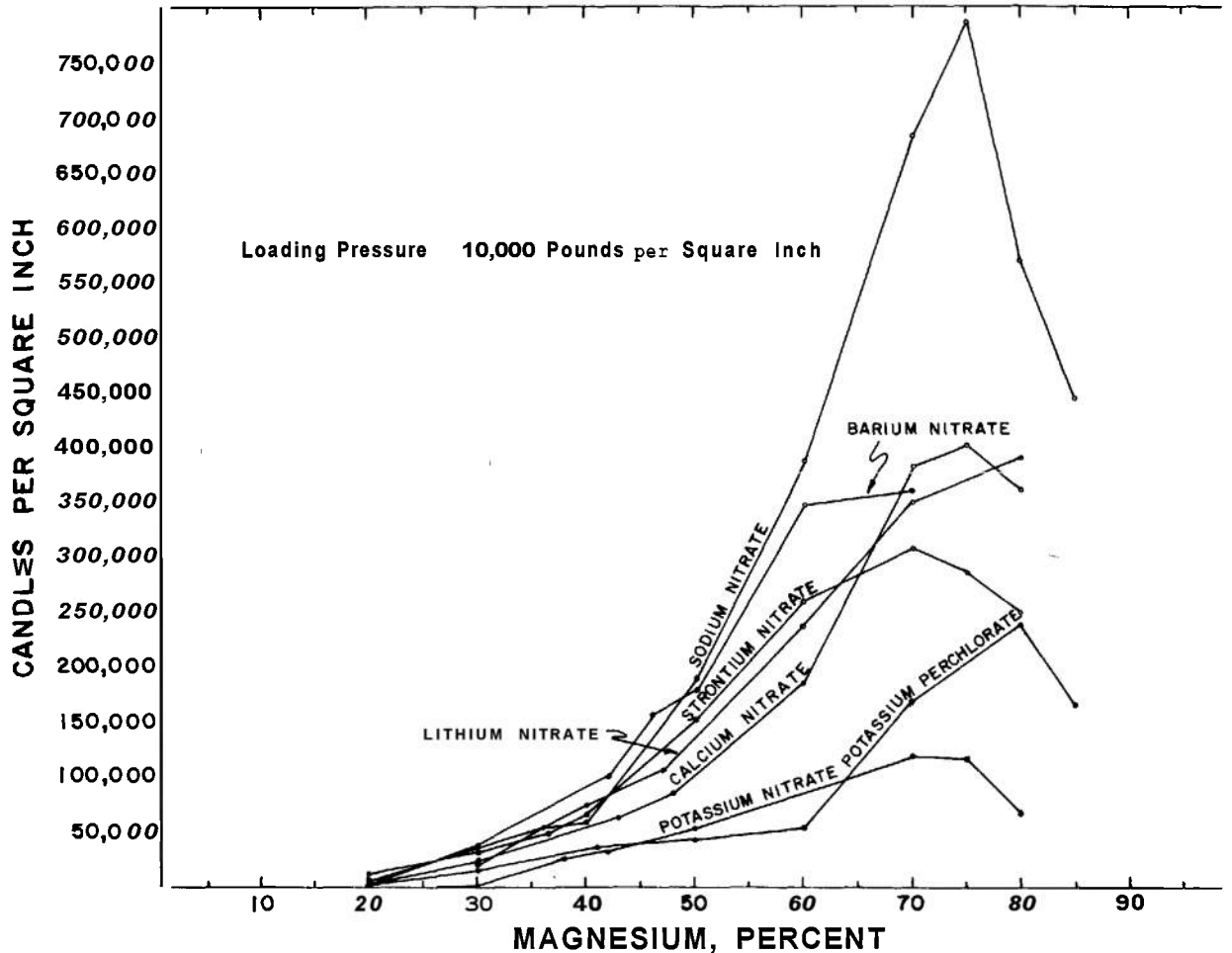

Figure 6-24. Luminous Intensity as a Function of Magnesium Content of Binary Mixtures Containing Various Oxidizing Agents

sizes are compared.<sup>43</sup> The ground magnesium (which for some sieve sizes will have the greater specific surface) gives a higher luminous intensity and a faster burning rate. An increase in burning rate and luminous intensity generally follows the increase of specific surface of the ingredients. It is to be noted, however, that an increase in burning rate and luminous intensity may be accompanied by a reduction in the overall efficiency.

The burning characteristics of pyrotechnic compositions are also affected by the specific surface of the oxidizers and other ingredients. While relatively little data are available on the specific effect produced in a particular system, it is important that they be considered.

### 6-3.5.7 Consolidation<sup>44</sup>

The degree of consolidation (loading pressure) has a varying effect on the burning rate and luminous intensity of a pyrotechnic mixture, depending on the physical characteristics of the components. Increased consolidation pressure results in an increased pellet density which approaches a maximum, which is usually five to ten percent less than the theoretical value. In Figure 6-33 and Table 6-12 are shown the effects of loading pressure on burning rate, luminous intensity, and other characteristics, between 2000 psi and 25,000 psi for magnesium-sodium nitrate flares. The linear burning rate shows a slight decrease with loading pressure while the mass burning rate and lum-

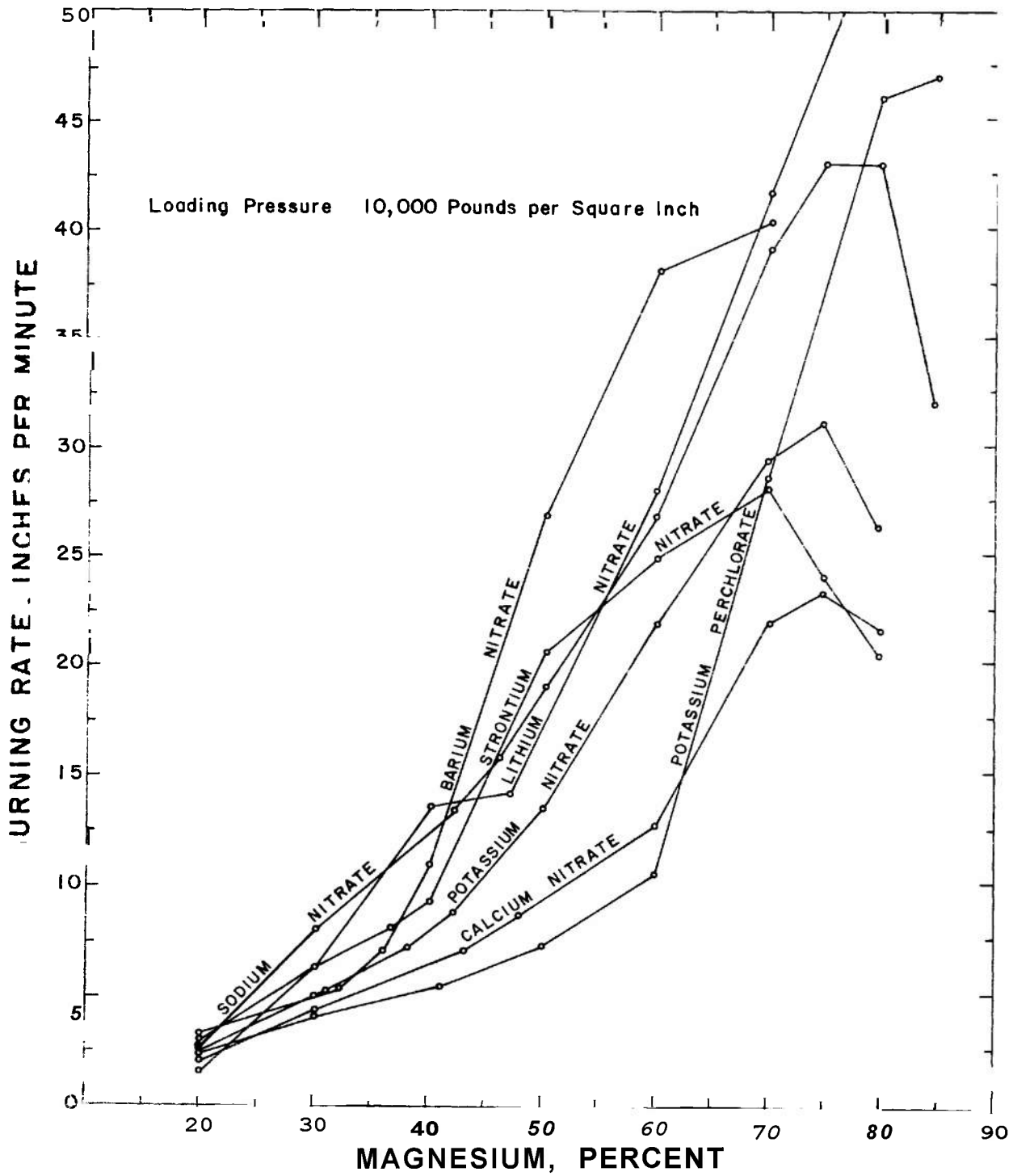

Figure 6-25. Burning Rate as a Function of Magnesium Content of Binary Mixtures Containing Various Oxidizing Agents

**TABLE 6-8(A)**  
**PHYSICAL DATA AND BURNING CHARACTERISTICS FOR STOICHIOMETRIC**  
**MIXTURES OF VARIOUS OXIDANTS WITH ATOMIZED MAGNESIUM**

<i>Oxidant</i>	<i>Stoichio- metric Ratio</i>	<i>Calculated Heat of Reaction</i>		<i>Luminous Intensity Candle/sq in.</i>	<i>Burning Rate, Efficiency, in./min candle-sec/g</i>	
		<i>Kcal</i>	<i>Cal/g</i>			
LiNO <sub>3</sub>	53.2/46.8	631.0	2430	109,000	13.9	17,500
NaNO <sub>3</sub>	58.3/41.7	595.4	2060	102,000	13.1	15,500
KNO <sub>3</sub>	62.5/37.5	569.8	1760	27,500	6.9	8,000
Ca(NO <sub>3</sub> ) <sub>2</sub>	57.5/42.5	647.1	2260	64,000	6.8	18,000
Sr(NO <sub>3</sub> ) <sub>2</sub>	63.5/36.5	626.8	1881	50,500	7.7	12,500
Ba(NO <sub>3</sub> ) <sub>2</sub>	68.8/31.8	615.5	1606	45,000	5.1	14,000
KClO <sub>4</sub>	58.8/41.2	515.8	2441	37,000	5.2	15,000

inous intensity show an increasing trend. These data have been found consistent with the trends observed in most pyrotechnic compositions containing magnesium although they are not as consistent for compositions containing aluminum.

Insufficient consolidation of tracer composition in the tracer cavity may result in the tracer malfunction known as "blow out," where the pyrotechnic composition is ejected from its cavity. This usually happens shortly after the projectile leaves the gun. In ammunition depending on tracer functioning for self-destruction, this usually results in a premature projectile functioning.

The required loading pressure or extent of consolidation depends on the setback forces and amount of rough handling to which the item is to be subjected. Generally, the greater the setback forces, the greater the required loading pressure.

### 6-3.5.8 Flare Diameter

The influence of flare diameter on the linear and mass burning rate, luminous intensity, temperature distribution, color value, luminous efficiency, and flame geometry may vary considerably depending on general configuration of the system and the pyrotechnic composition. A basic end-burning flare, free from the influences of case geometry and composition and associated materials, should possess a linear burning rate essentially independent of the flare diameter. This has been the case in many investigations conducted over rather limited diameter ranges; however, in

other cases the results have varied considerably. With certain compositions, investigators have observed an apparent maximum in linear burning rate associated with a particular flare diameter.<sup>45</sup>

Investigations of typical yellow, green, and red flare compositions with diameters varying between 0.6 inch to 1.1 inches indicated that the luminous intensity could be expressed mathematically by an equation of the form:<sup>46</sup>

$$y = ax^n \quad (6-15)$$

(for diameters less than approximately 4 in.) where  $y$  is the luminous intensity (candela),  $a$  is a constant,  $x$  is the flare diameter in inches, and  $n$  is a constant. The value of  $n$ , which was obtained when the results were plotted on log-log paper, indicated that  $n$  is slightly greater than 2.0 which may be due to some change in the flame geometry, or to an increase in the flame temperature. The flame area tended to exhibit a direct proportionality with the square of the flare diameter. Yellow and green flares showed an increase in luminous efficiency with increased luminous intensity; however, their flames appeared to become less saturated with increasing flare diameter. Red flares exhibited maximum luminous efficiencies for intermediate values of luminous intensity and the color characteristics did not appear to change with an increase in flare diameter.

### 6-3.5.9 Case Materials and Coating

Both the physical and chemical characteristics of pyrotechnic case material and associated coat-

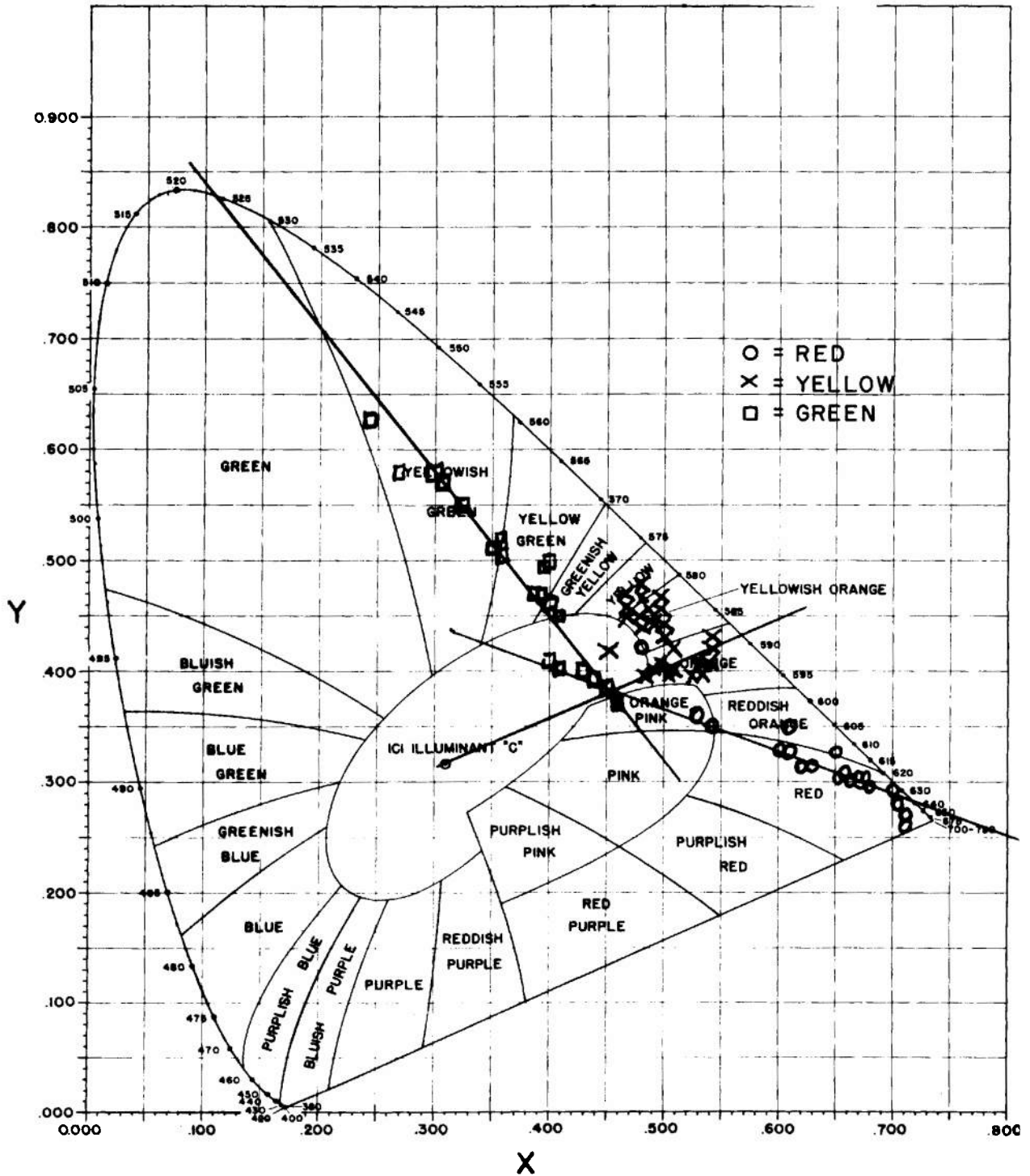

Figure 6-26. Chromaticity Data for Red, Yellow, and Green Flares

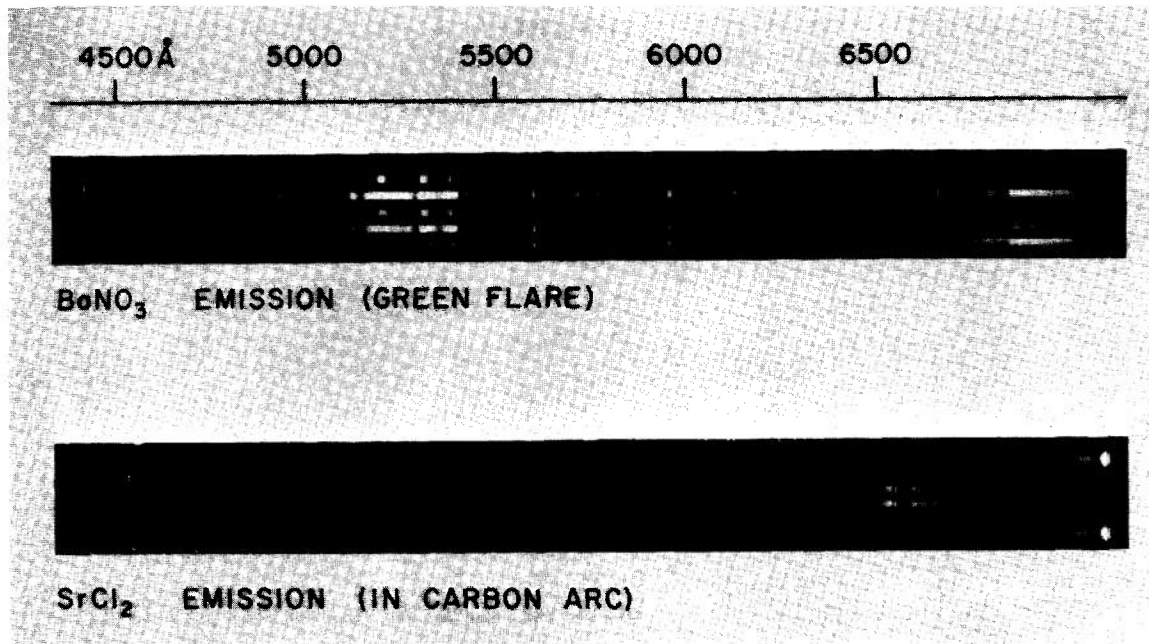

Figure 6-27. Typical Spectra of Signal Flares

ing may affect the burning characteristics and luminous output of flares. Steel cases with high thermal conductivities, as compared to those constructed of paper or other materials, may preheat the composition and thus tend to decrease the time to ignition and increase the burning rate. In addition, the increased wall temperature may affect the coating material and promote side burning. Both of these conditions tend to increase the luminous intensity; however, they can cause unpredictable performance.

In studies of colored flare illuminating composition~it was found that red and yellow flares had higher burning rates and luminous intensities when using steel cases as opposed to paper cases. When paper-lined steel cases were used, luminous intensity values were midway between those for steel and those for paper, although burning rates were comparable to those obtained for paper cases. In contrast, the relatively cooler-burning green composition gave lower luminous intensity values in the steel case than in the paper case (for which intermediate values were obtained) even though the burning rates remained essentially the same. In this case, the heat loss to the surroundings from

the steel case may more than compensate for the increase observed with red and yellow flare compositions. Some compositions also have been observed to burn more rapidly and produce a greater luminous intensity in laminated plastic cases than when loaded into paper cases. In this case, the character of the adherence of the composition to the wall may be important; however, a completely satisfactory explanation is difficult.

#### 6-3.5.10 Temperature and Pressure

Ambient pressure and temperature have been found to have varying effects on the operating characteristics of illuminating flares, depending on the composition. In a study<sup>48</sup> made on yellow, red, and green compositions it was found that at a reduced temperature,  $-65^{\circ}\text{F}$ , the candlepower and burning time of the flares, except for green, decreased. The color value was found to be affected differently, depending on the composition at this temperature. (See Tables 6-13, 6-14, and 6-15.) At high simulated altitudes, the burning time increased while the candlepower decreased for most flares tested in this study. Color values were increased at the higher simulated altitudes with the



TABLE 6-8(B)  
CHARACTERISTICS OF BINARY MIXTURES CONTAINING OXIDIZING AGENTS  
AND ATOMIZED MAGNESIUM, GRADE A

Composition* Parts by Weight		Horizontal Luminous Intensity, Candles per Square Inch	Burning Rate, in./min	Yellow Color Value	Ignition Temperature °N	Ignitibility A4 Black Powder, g	Impact Test B.W. App.,†	Pendulum Friction Test Reaction with		180°C Vacuum Stability Test, cc, gas/40 hrs.	Density, gas/cc	Efficiency, Candle- Seconds per gram
Sodium Nitrate	Atom. Gr. A (125g.) magnesium							Steel Shoe	Fiber Shoe			
80	20	4,500	2.4	—	635	>5	85	None	—	0.30	1.91	3,600
70	30	38,500	7.7	—	630	>5	95	None	—	0.35	1.87	9,700
58	42	102,000	13.1	0.025	630	0.5	100+	None	—	0.32	1.82	15,800
54	46	155,000	15.6	0.024	635	0.5	100+	None	—	0.31	1.79	20,000
50	50	180,000	16.5	0.026	635	1.25	100	None	—	0.36	1.74	20,000
40	60	388,000	26.7	0.029	620	1.25	100	None	—	0.32	1.71	31,000
30	70	685,000	39	0.030	620	1.75	100	None	—	0.32	1.65	38,000
25	75	785,000	43	0.033	—	>5	100+	None	—	—	1.62	41,000
20	80	570,000	43	0.038	570	>5	100+	None	—	0.33	1.59	30,000
15	85	445,000	32	0.041	570	>5	100+	None	—	0.23	1.51	33,000
Barium Nitrate		Atom. Gr. A Magnesium										
80	20	6,500	2.9	pale green	680	>5	100+	None	—	0.25	2.49	3,300
68	32	45,000	5.1	pale green	670	>5	100+	None	—	0.25	2.24	14,000
64	36	53,000	6.7	pale green	640	>5	100+	None	—	0.15	2.21	13,000
60	40	59,500	10.7	pale green	635	>5	100+	None	—	0.18	2.08	9,800
50	50	126,000	16.8	pale green	615	>5	100+	None	—	0.21	1.96	13,000
40	60	348,000	33.1	pale green	625	>5	100+	None	—	0.16	1.86	17,500
30	70	360,000	40.3	pale green	615	>5	100+	None	—	0.20	1.84	17,500
20	80	—	Erratic Burning	—	625	>5	100+	None	—	0.22	1.63	—
Strontium Nitrate		Atom. Gr. A Magnesium		Red Color Value								
80	20	10,500	2.7	0.20	615	>5	100+	None	—	0.13	2.32	6,500
70	30	34,000	6.0	0.19	600	>5	100+	None	—	0.16	2.05	10,000
68.5	31.5	50,500	7.7	0.18	600	>5	100+	None	—	0.15	1.95	12,500
60	40	68,500	8.9	0.16	600	>5	100+	None	—	0.14	1.92	12,000
50	50	152,000	21.1	0.22	610	>5	90	None	—	0.14	1.79	14,500
40	60	280,500	24.8	0.24	610	>5	100	None	—	0.19	1.72	22,000
30	70	307,000	33.0	0.26	615	>5	100+	None	—	0.27	1.63	24,000
25	75	288,000	24.0	0.31	620	>5	100+	None	—	0.18	1.57	27,500
20	80	250,000	20.4	0.27	610	>5	100+	None	—	—	1.52	33,000
Lithium Nitrate		Atom. Gr. A Magnesium		Red Color Value								
80	20	—	Erratic Burning	—	—	—	—	—	—	—	1.88	—
70	30	21,000	6.01	0.17	—	—	—	—	—	—	1.77	7,200
60	40	78,500	13.3	0.16	—	—	—	—	—	—	1.68	12,500
53	47	109,000	13.9	0.18	—	—	—	—	—	—	1.62	17,500
40	60	238,000	27.9	0.20	—	—	—	—	—	—	1.54	20,000
30	70	350,000	41.6	0.21	—	—	—	—	—	—	1.49	29,000
20	80	370,000	45.1	0.20	—	—	—	—	—	—	1.43	22,000
Calcium Nitrate		Atom. Gr. A Magnesium		Red Color Value								
80	20	3,500	1.8	0.22	—	—	—	—	—	—	1.99	3,500
70	30	25,000	4.0	0.16	—	—	—	—	—	—	1.86	11,500
57	43	64,000	6.8	0.16	—	—	—	—	—	—	1.86	18,500
52	48	88,000	8.4	0.18	—	—	—	—	—	—	1.81	20,000
40	60	188,000	12.5	0.25	—	—	—	—	—	—	1.73	32,000
30	70	382,000	22.0	0.28	—	—	—	—	—	—	1.56	40,000
25	75	400,000	23.3	0.29	—	—	—	—	—	—	1.51	43,000
20	80	362,000	21.5	0.30	—	—	—	—	—	—	1.50	43,000
Potassium Nitrate		Atom. Gr. A Magnesium										
80	20	900	2.3	white	660	>5	80	None	—	0.16	1.81	600
70	30	1,100	4.7	white	650	2.75	80	None	—	0.13	3.75	500
62	38	27,500	6.9	white	660	1.5	90	None	—	0.15	1.73	8,400
58	42	38,000	8.5	white	655	2	75	None	—	0.11	1.72	9,000
50	50	55,000	13.3	white	650	1.75	90	None	—	0.15	1.68	9,000
40	60	88,000	21.8	white	645	1.75	90	None	—	0.13	1.62	9,000
30	70	119,000	29.3	white	635	1.5	100	None	—	0.13	1.56	9,500
25	75	116,000	31.1	white	—	4	100+	None	—	0.19	1.53	9,000
20	80	70,000	26.4	white	630	>5	100+	None	—	0.13	1.53	6,300
Potassium Perchlorate		Atom. Gr. A Magnesium										
80	20	2,500	2.2	White	700	>5	100+	None	—	0.30	1.91	2,100
70	30	17,500	3.8	White	710	>5	100+	None	—	0.24	1.78	9,500
59	41	37,000	5.2	White	705	>5	100+	None	—	0.28	1.72	15,000
50	50	45,000	7.0	white	715	>5	100+	None	—	0.25	1.66	14,000
40	60	54,000	10.3	white	700	6	100+	None	—	0.26	1.60	12,000
30	70	171,000	26.5	white	700	>5	100+	None	—	0.35	1.54	14,500
20	80	240,000	46	white	—	—	100+	None	—	0.22	1.51	12,500
15	85	167,000	47	white	—	—	100+	None	—	—	1.50	8,500

\*Loading Pressure 10,000 pair in 1.4 Square Inch Candle Cases.  
†Bureau of Mines Apparatus.

**TABLE 6-9**  
**CHARACTERISTICS OF PYROTECHNIC COMPOSITIONS**  
**CONTAINING VARIOUS POLYESTER RESIN BINDERS**

<i>Polyester Resins</i>	<i>Candlepower, 1000 Candles</i>	<i>Burning Rate, inch/minute</i>	<i>Total Integral Light, 10<sup>6</sup> Candle-seconds</i>	<i>CIE Coordinates</i>	
				<i>x</i>	<i>y</i>
Hetron-92	<b>84.0</b>	4.4	3.7	0.52	0.35
Paraplex-43	70.3	3.5	<b>4.0</b>	<b>0.54</b>	0.35
Paraplex-444	65.0	4.2	3.2	<b>0.50</b>	0.35
Laminac 4116	64.5	3.8	3.3	0.51	0.36
Paraplex-13	62.5	3.3	3.7	<b>0.53</b>	0.35
Paraplex-47	62.0	3.4	3.5	0.52	0.36
Glidpol-1001-A	61.2	3.5	3.4	0.52	0.35
Interchemical-401	60.5	3.9	3.5	0.57	0.32
Pleogen-1150	60.3	4.0	3.2	0.54	0.34
Aropol-7120	60.0	3.8	3.5	<b>0.56</b>	0.33
Polylite-8001	59.3	4.1	3.3	<b>0.56</b>	0.33
Interchemical-937	<b>58.0</b>	4.0	3.3	0.57	0.33
Polylite-8007	56.8	3.8	3.2	<b>0.55</b>	<b>0.34</b>
4116-85%:4134-15%	56.6	4.1	3.2	<b>0.55</b>	0.33
Aropol-7300	56.4	4.3	3.0	0.56	0.33
Pleogen-1006	56.4	4.1	<b>3.0</b>	<b>0.55</b>	<b>0.34</b>
ED-199	56.2	4.1	3.2	0.57	0.32
PLL-4262	<b>56.0</b>	4.1	3.1	<b>0.58</b>	0.32
Vibrin-1088-B	54.5	3.4	3.4	<b>0.56</b>	0.33
Paraplex-49	54.4	3.4	3.1	0.52	0.35
Laminac-4134	53.7	3.9	3.0	<b>0.55</b>	<b>0.34</b>
Vibrin-117	52.9	3.9	3.0	<b>0.55</b>	0.33
inter chemical-312	51.7	4.1	2.9	<b>0.56</b>	0.32
Celanese-MX-314	51.4	4.0	2.8	0.55	0.34
Interchemical-1191	51.4	4.0	2.9	<b>0.56</b>	0.33
Interchemical-730	51.4	3.7	3.1	0.57	0.32
Interchemical-1154	50.2	4.0	2.9	<b>0.56</b>	0.33
Stypol-4051	49.5	3.8	2.8	0.55	0.33
Stypol-405	49.1	4.0	2.7	<b>0.55</b>	0.34
<b>Aropol-7110</b>	49.0	4.2	2.7	<b>0.56</b>	0.33
Selectron-5027	48.4	3.7	2.9	<b>0.55</b>	0.34
Celanese MR 28-C	46.0	4.0	2.6	<b>0.55</b>	0.34
<i>Epoxy Resin</i>					
Bakelite ERL-2795	81.2	5.1	3.8	0.59	0.30

exception of green which remained essentially constant.

The range of altitudes at which pyrotechnic items may be used is from zero to approximately 250,000 feet. The effects produced under reduced pressures can be attributed to both the reduction in oxygen and ambient pressure. The effects of oxygen reduction may be greater when fuel-rich mixtures are burned. For stoichiometric or near-stoichiometric compositions, the effect is mainly that of pressure. It has been shown that by maintaining a pressure over the flare surface through partial confinement by use of a nozzle, the burning rate at high simulated altitude could be raised to the same level as that at sea level.<sup>49</sup>

Larger flame plumes are produced as the ambient pressure is reduced due to the decrease in

resistance offered by the air molecules. Intermediate reactions occur further away from the flare surface and, in many cases, a "dark zone" can be observed just above the flare surface and initial reaction zones. If the pressure becomes low enough, a point will be reached where the reaction will not be self-sustaining.

The inverse relationship between candlepower and color value is attributed to the increasing importance of the color line and band emission from excited atoms and molecules at the higher altitudes.

#### 6-3.5.11 Rotational Spin

The effect of rotational spin on the burning characteristics of compositions has been investigated. It has been found that the rotational spin

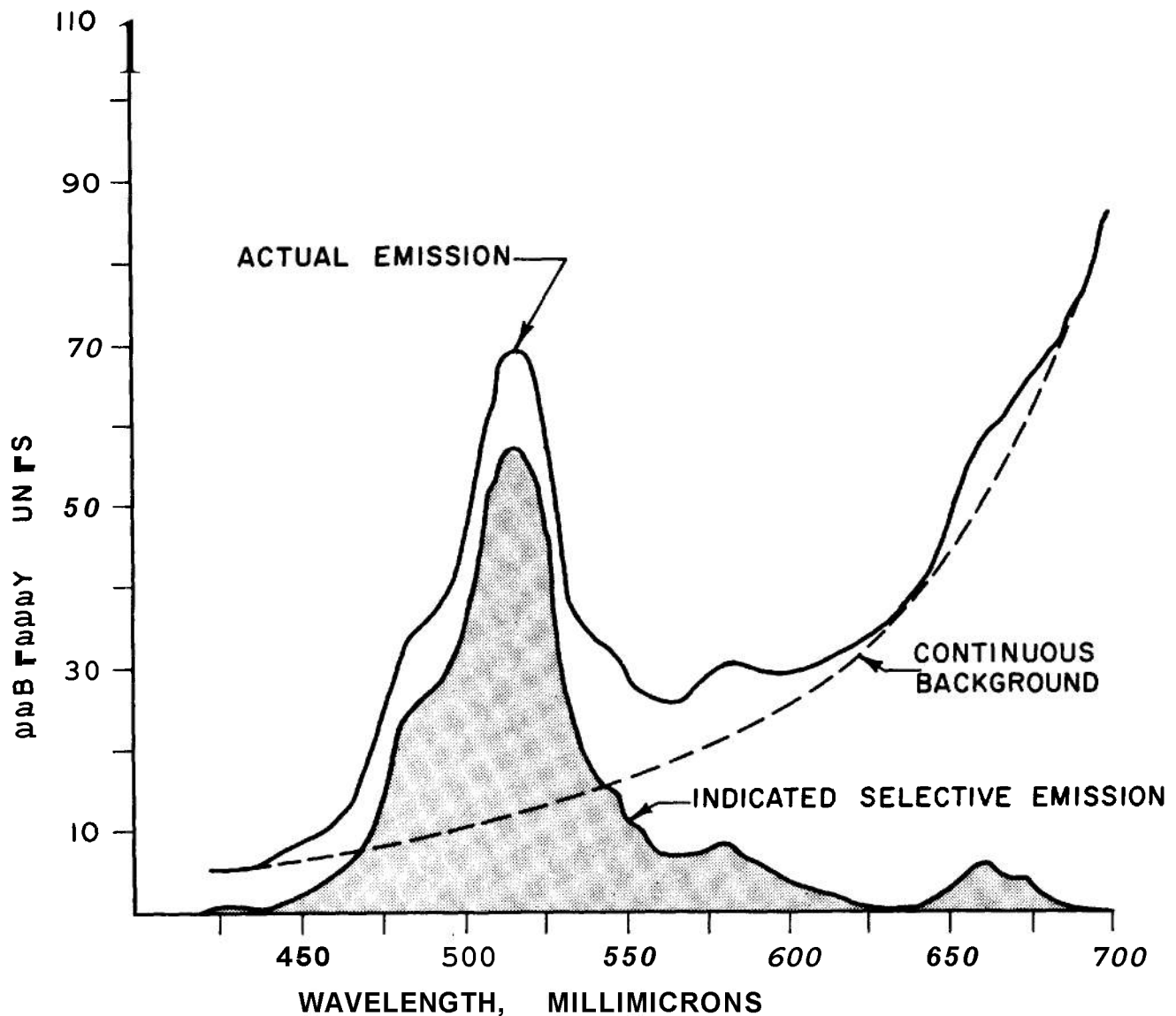

Figure 6-28. Spectral Energy Distribution of Green Flare

of a 105 mm illuminating projectile canister considerably shortened the burning time of the illuminant. The effect of rotational spin on flares loaded in 1.5-inch O.D. steel flare cases was also studied. Examination of burned out flare cases indicated that the resulting centrifugal forces prevents the expulsion of much of the slag. The slag builds up and effectively decreases the internal diameter of the case. This decrease in internal case diameter prevents the efficient expulsion of gases formed and thus causes an increase in the internal pressure. As a result of the pressure increase, the illuminants burn more rapidly. This is substanti-

ated by the fact that flares which are rotated at the slowest speeds (which have the longest burning times) show much less slag residue than those rotated at higher speeds. Flares tested at speeds of 3,000 to 5,000 rpm, however, all contain approximately the same amount of slag.

In another study, the trace duration of a tracer was found to be shortened, as shown in Figure 6-34,<sup>50</sup> by rotational spin. Burning rates for tracer compositions increased with an increase in diameter, or length of tracer column and this increase was more pronounced as angular speed was increased. In general, for each composition the per-

**TABLE 6-10**  
**EFFECT OF PARTICLE SIZE ON BURNING RATE**  
**AND CANDLEPOWER FOR MAGNESIUM-SODIUM NITRATE-**  
**POLYVINYLCHLORIDE-LAMINAC MIXTURE**

Ingredients	Average Particle Size, <i>microns</i>	Percentages			
Magnesium, At., 20/50	437	48			
Magnesium, At., 30/50	322		48		
Magnesium, At., 50/100	168			48	
Magnesium, At., 100/200	110				48
Sodium Nitrate, DR, ULP	34	42	42	42	42
Polyvinylchloride	27	2	2	2	2
Laminae Resin 4116	—	8	8	8	8

	Time-Intensity Data			
Candlepower, 10 <sup>3</sup> candles	130	154	293	285
Burning Rate, in./min	2.62	3.01	5.66	5.84

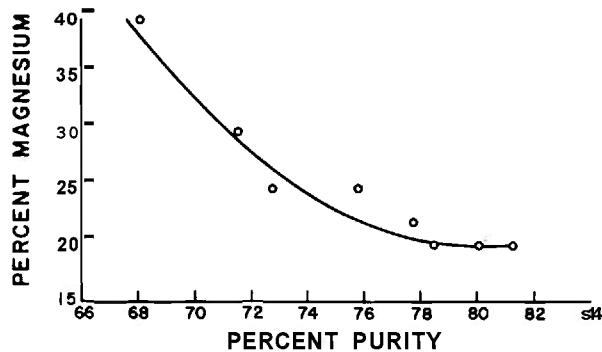

Figure 6-29. Magnesium Content Versus Excitation Purity for a Yellow Flare

centage loss of slag decreased for each diameter with an increase in rotational speed. Total light output expressed in candlepower seconds decreased with an increase in rotational speed.<sup>50</sup>

**6-3.5.12 Moisture and Stability**

One of the important factors in determining the stability and shelf life of a pyrotechnic item is the sensitivity of the pyrotechnic composition to atmospheric moisture. In the presence of moisture, the oxidant will react with the metal particles to form a layer of metal oxide, metal

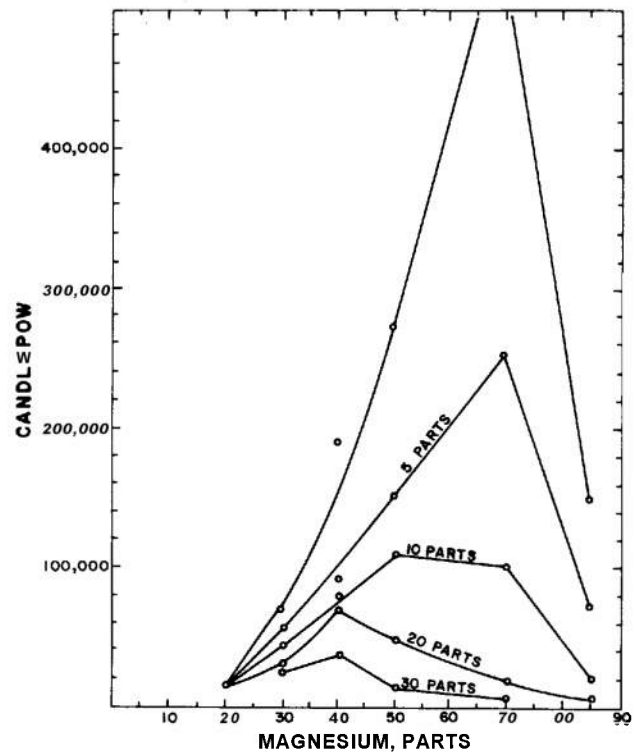

Figure 6-30. Effect of Polyvinylchloride on the Candlepower of Mixtures Containing Strontium Nitrate and Ground Magnesium, Grade A

hydroxide, or both. This nonreactive layer changes the ignition and propagative characteristics of the

**TABLE 6-11**  
**EFFECTS OF CHANGE IN SPECIFIC**  
**SURFACE OF MAGNESIUM PARTICLES**

	<i>Ground Magnesium</i>	<i>Atomized Magnesium</i>
<b>COMPOSITION, %</b>		
Ground magnesium	66.6	—
Atomized magnesium	—	66.6
Sodium nitrate	28.6	28.6
Resin	4.8	4.8
	(100.0)	(100.0)
<b>CHARACTERISTICS</b>		
Candles per sq in.	200,000	178,000
Burning rate, in./min	9.4	.57
Density	1.56	1.65
Candle-seconds/gram	50,000	69,200

pyrotechnic mixture so that reduced luminous intensity or nonignition may result.

The critical relative humidity is a measure of the sensitivity of oxidants to moisture. It is determined by exposing samples of the oxidizers to atmospheres of known relative humidities and determining the change in weight of the oxidizer. The critical relative humidity is that at which, with respect to moisture content, the oxidizer is in equilibrium with its surroundings. Roughly, the higher the critical relative humidity, the less soluble the oxidant. Small traces of impurities may lower the critical relative humidity of a compound.

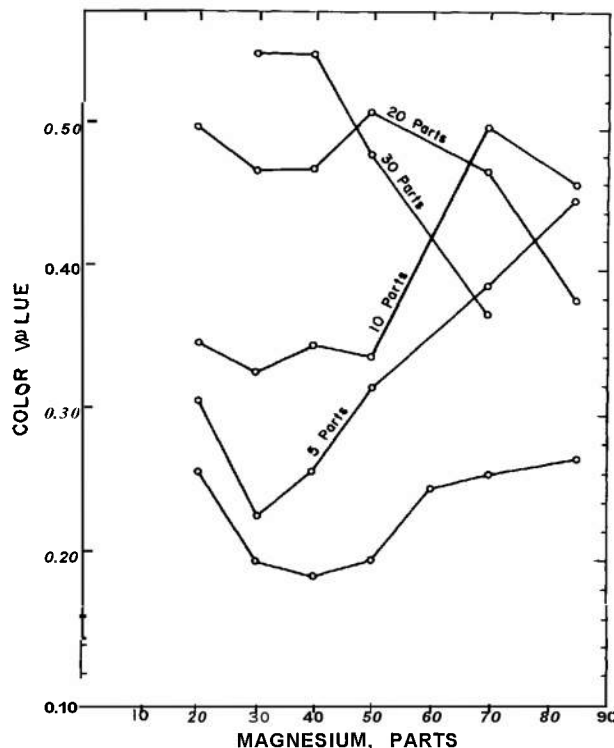

**Figure 6-37. Effect of Polyvinylchloride on the Color Value of Mixtures Containing Strontium Nitrate and Ground Magnesium, Grade A**

In some cases, it has been found expedient to compromise due to an oxidizer's excellent oxidizing ability. This has been the case with sodium nitrate that formerly had a critical humidity of 50 percent for the specification grade. The use of U.S.P. double-refined sodium nitrate with a critical

**TABLE 6-12**  
**EFFECTS OF LOADING PRESSURE ON BURNING CHARACTERISTICS**  
**OF 'MAGNESIUM-SODIUM NITRATE FLARES**

<i>Loading Pressure, Psi</i>	<i>Luminous Intensity, 1000 Candles</i>	<i>Total Light, IX10<sup>6</sup> Candle- Seconds</i>	<i>Burning Rate, Inches Per Minute</i>	<i>Burning Rate, G Per Second</i>	<i>Color Ratio</i>	<i>Chromaticity Coordinates,</i>		<i>Luminous Efficiency, 1000 C-Sec Per Gram</i>	<i>Composition Density, Grams Per CG</i>
						<i>x</i>	<i>y</i>		
2,000	278	7.2	6.20	6.54	0.036	0.48	0.46	42.6	1.54
4,000	292	7.0	6.33	7.20	0.036	0.48	0.46	40.7	1.64
7,000	262	7.1	5.62	6.75	0.037	0.48	0.46	38.7	1.74
10,000	270	7.3	5.47	7.12	0.035	0.48	0.46	37.9	1.90
15,000	286	7.4	5.63	7.69	0.035	0.48	0.45	37.2	2.03
20,000	291	7.6	5.67	7.55	0.035	0.48	0.46	38.6	1.95
25,000	290	7.5	5.92	7.69	0.037	0.48	0.45	37.8	1.88

TABLE 6-13  
EFFECT OF SIMULATED ALTITUDE AND TEMPERATURE  
ON ILLUMINATION CHARACTERISTICS OF YELLOW SIGNALS

<i>Simulated Altitude, "</i> <i>Feet</i>	<i>Temperature,</i> <i>°F</i>	<i>LOT Y-1</i>			<i>LOT Y-2</i>		
		<i>Average Luminous Intensity, Candles</i>	<i>Burning Time, Seconds</i>	<i>Yellow** Color Value</i>	<i>Average Luminous Intensity, Candles</i>	<i>Burning Time, Seconds</i>	<i>Yellow** Color Value</i>
0	70	53,300	19	.038	124,000	9.3	.052
10,000	70	39,200	21	.047	113,000	11	.062
20,000	70	19,200	24	.058	91,000	9.5	.062
40,000	70	6,650	49	.064	55,000	12	.072
0	-65	44,500	16.5	.055	78,000	9.5	.074

\* Pressure reduced to simulate condition at altitudes shown.

\*\* The color value was determined using the procedure given in PA Tech Report No. 1385.

TABLE 6-14  
EFFECT OF SIMULATED ALTITUDE AND TEMPERATURE  
ON ILLUMINATION CHARACTERISTICS OF RED SIGNALS

<i>Simulated Altitude, '</i> <i>Feet</i>	<i>Temperature,</i> <i>°F</i>	<i>LOT R-1</i>			<i>LOT R-2</i>		
		<i>Average Luminous Intensity, Candles</i>	<i>Burning Time, Seconds</i>	<i>Red** Color Value</i>	<i>Average Luminous Intensity, Candles</i>	<i>Burning Time, Seconds</i>	<i>Red** Color Value</i>
0	70	26,400	18.3	.44	48,000	14	.56
10,000	70	17,200	22.5	.47	30,000	19	.59
20,000	70	14,500	27	.53	25,700	22	.60
40,000	70	9,300	41	.62	15,500	35	.69
0	-65	25,400	16.5	.40	38,000	14.5	.60

\* Pressure reduced to simulate condition at altitudes shown.

\*\* The color value was determined using the procedure given in PA Tech Report No. 1385.

humidity of 75 percent partly alleviated this problem.<sup>43</sup>

The effect of moisture on a finely powdered metal can be determined by placing a sample in distilled water and maintaining the system at a specified constant temperature. By collecting the gas evolved at constant pressure, the rate of corrosion of the metal can be established. For atomized magnesium,<sup>51</sup> it was found that the rate of corrosion increased with time but only slightly between the temperatures of 30°C and 65°C. At-

mospheres of nitrogen and oxygen exerted only a slight influence on the corrosion rate whereas hydrogen and carbon dioxide were observed to have retarding and accelerating effects, respectively. Further, the rate of corrosion increased with an increase in specific surface.

One way that the deleterious effect of moisture on magnesium or other metal can be avoided is to coat the metal with a thin chromate film. Protection of the atomized magnesium in consolidated illuminating and signal compositions may also be

**TABLE 6-15**  
**EFFECT OF SIMULATED ALTITUDE AND TEMPERATURE**  
**ON ILLUMINATION CHARACTERISTICS OF GREEN SIGNALS**

Simulated Altitude,* Feet	Temperature, °F	LOT G-1			LOT G-2		
		Average Luminous Intensity, Candles	Burning Time, Seconds	Green <sup>XX</sup> Color Value	Average Luminous Intensity, Candles	Burning Time, Seconds	Green <sup>**</sup> Color Value
0	70	14,300	16.5	.36	38,700	16	.35
10,000	70	14,300	21.5	.39	20,500	15	.36
20,000	70	11,500	26.5	.37	20,500	17	.36
40,000	70	11,000	30	.41	19,500	26	.35
0	-65	27,800	20	.36	35,700	15	.35

\* Pressure reduced to simulate condition at altitudes shown.

\*\* The color value was determined using the procedure given in PA Tech Report No. 1385.

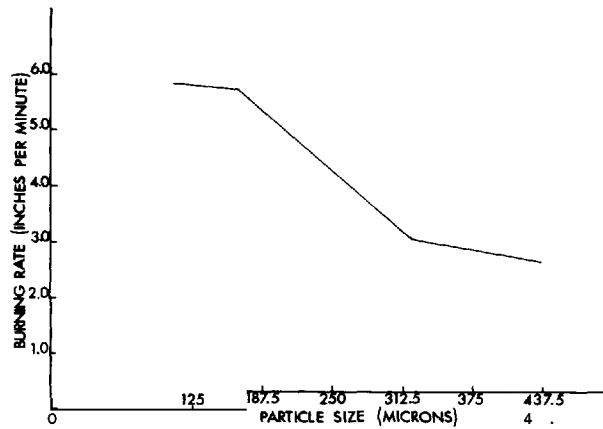

figure 6-32.1. Burning Rate vs Particle Size of Magnesium

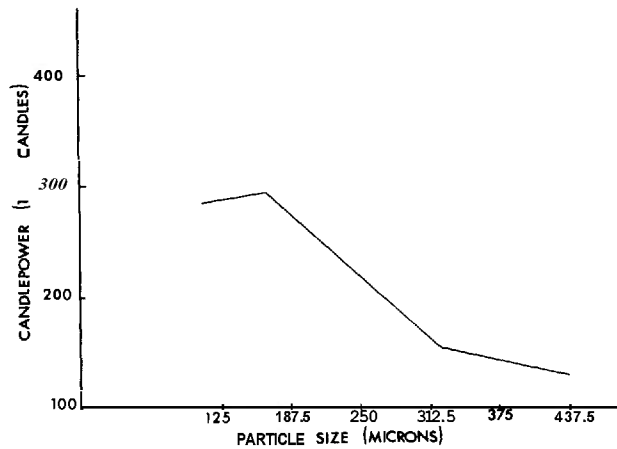

Figure 6-32.2. Candlepower vs Particle Size of Magnesium

accomplished by the use of binders and water-proofing agents, usually an oil, wax, or plastic resin. Containers and nonhygroscopic first-fire compositions are used to keep moisture from the main illuminating compositions.

**6-4 NONCONSOLIDATED ILLUMINANT CHARGES**

As pyrotechnic reactions, in general, are based on the chemical reaction of a fuel with an oxidizer, the manner in which these two basic ingredients are incorporated into a pyrotechnic device will greatly influence its performance. Noneconsolidated illuminants differ from consolidated illu-

minants because they do not contain binders and are loose-loaded which changes the manner in which they react to produce light. Consolidated compositions burn comparatively slowly while non-consolidated mixtures, under confinement, react rapidly producing a bright flash of light.

The major uses for nonconsolidated illuminant charges are in photoflash bombs and cartridges for night aerial photography, and in spotting charges for tracking and acquisition purposes. Noneconsolidated fillers include: (1) intimate mixture of a powdered metal and powder oxidant, (2) a powdered metal, such as aluminum, magnesium, or their alloys, and (3) a powdered metal and a

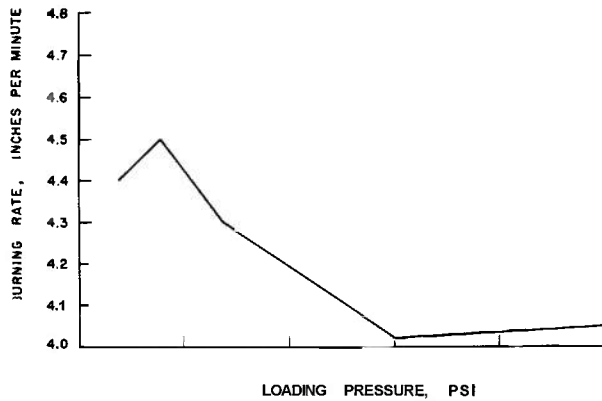

Figure 6-33. Effect of loading Pressure on Burning Rate of Pyrotechnic Compositions

powdered oxidant segregated from each other in concentric cylinders.

#### 6-4.1 AERIAL PHOTOGRAPHIC ILLUMINANTS

The mission of aerial photography is to obtain information regarding the static content of an area (buildings, roads, etc.), and the movement of personnel and equipment. At night, this requires a light source that will produce sufficient illumination to obtain usable negatives. High intensity light sources for night aerial photography may be broadly divided into two classes, pyrotechnic light sources, and the electronic flash tube.<sup>52</sup> As flash tubes are unable to produce as much light as pyrotechnic light sources, their use is limited to low altitudes. At higher altitudes, photoflash cartridges and photoflash bombs are the only practical sources of intense illumination for night aerial photography using conventional aerial cameras and photographic film.

The film speed, basically, determines the amount of light which must fall on the film in order to obtain a satisfactory negative. The amount of light which reaches the photographic film depends on:

a. Amount of light reflected from the area to be photographed, which depends on the illumination and the terrain reflectance of the area,

b. Relative aperture of the camera lens which is normally expressed by  $f$  values on a lens barrel are the diameter of the lens aperture divided by the focal length of the lenses. The transmission characteristics of the atmosphere determine the por-

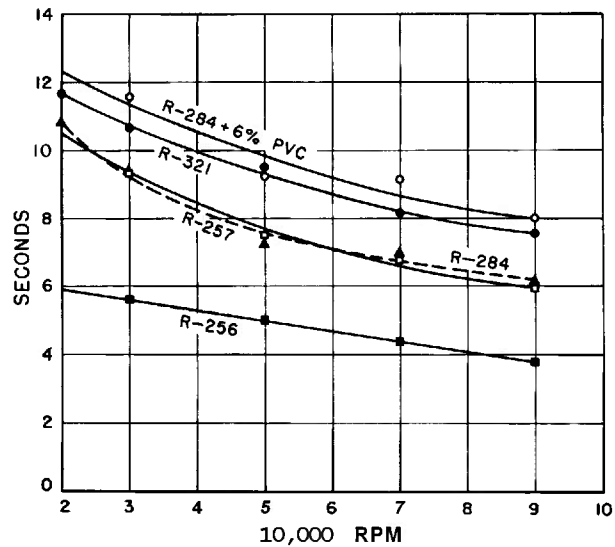

Figure 6-34. Effect of Spin Upon Trace Duration of Various Standard Tracer Compositions When loaded Into Caliber .50 M1 Jacket

tion of the light reflected from the area to be photographed which reaches the photographic film, and

c. Exposure time which, for night aerial photography, may be the duration of illumination and not the shutter speed.

The intensity of the light source and its relative location determine the illumination received by the area to be photographed as well as the uniformity of the illumination produced. As shown in Figure 6-35, the location of a pyrotechnic light source can be specified by giving the trail angle and the burst altitude. The trail angle must be sufficiently greater than the camera half-angle to assure that only the reflected light from the area being photographed will reach the camera lens.

For a normal trail angle value, the optimum burst altitude has been determined to be about 0.6 of the flight altitude, when the required intensity of the light source is a minimum.<sup>53</sup> At the optimum burst height the amount of light required for a satisfactory negative is approximately:<sup>52</sup>

$$I = \frac{6.4U_i (hf)^2}{T} \quad (6-16)$$

where  $I$  is the candlepower of the light source,  $T$  is the exposure time,  $f$  is the effective  $f$  value for the lens,  $h$  is the slant distance from the camera



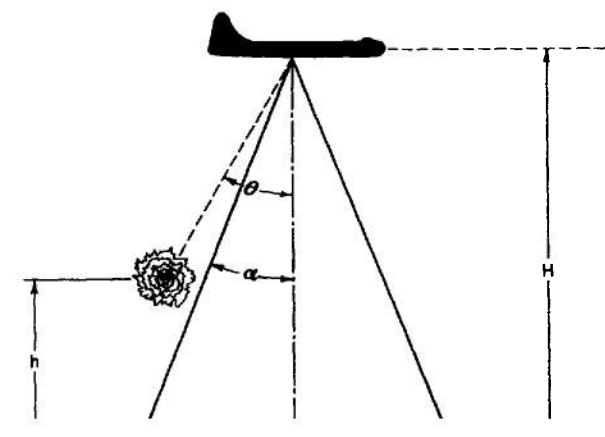

$\theta$  = TRAIL ANGLE                       $H$  = FLIGHT ALTITUDE  
 $\alpha$  = CAMERA HALF-ANGLE         $h$  = BOMB BURST ALTITUDE

Figure 6-35. Diagram of Bomb Burst and Trail Angle

lens to area being photographed, and  $U_i$  is a factor best determined experimentally. However, as shown in Figure 6-36 (which is a typical characteristic curve for black and white negative material), it is impossible to estimate the exposure  $U_i$  required to produce a negative of satisfactory photographic density. Military specification for film is based on the reciprocal of twice the exposure of a point on the curve at which the slope of the longest is one-half gamma; for this film the military speed is 300 ASA. A satisfactory exposure would correspond to about one-half way up the linear part of the characteristic curve, i.e., for this material an exposure of approximately  $0.05 \log E$  units.

#### 6-4.1.1 Photoflash Cartridges

Illumination for relatively low altitude night aerial photography is furnished by photoflash cartridges. As shown in Figure 6-37, these cartridges contain a photoflash charge and a delay fuze assembled into a charge case. This subassembly is put into an electrically primed outer cartridge case along with a small expelling charge. The cartridges are loaded into specially designed ejectors. Ejection and functioning of the cartridge are initiated by an electric pulse which causes the electric primer to function which, in turn, ignites the ex-

PELLING charge which ejects the inner charge. At the same time, the delay fuze is initiated and, at the end of the delay time, a relay explosive charge is initiated and, in turn, initiates the photoflash mixture. As the delay time determines the location of the burst behind (and below) the aircraft, the proper delay time will depend on the speed of the aircraft during the photographic mission. For this reason, photoflash cartridges are furnished with the different delays indicated in Table 6-16 which summarizes the characteristics of some photoflash cartridges. Characteristics of a typical photoflash composition are shown in Table 6-17.

#### 6-4.1.2 Photoflash Bombs

Illumination for high altitude night photography is provided by photoflash bombs which are released from the aircraft during the photographic run. A typical photoflash bomb is shown in Figure 6-38. Descriptive data and characteristics of photoflash bombs containing photoflash powder are summarized in Table 6-18.

Photoflash bombs containing a relatively large amount of flash powder can be very dangerous since they can be exploded by impact. Because of this danger, dust-type photoflash bombs were developed. The characteristics of dust-type photoflash bombs are summarized in Table 6-19.

In 1950, the development of a segregated oxidant bomb in which the burster oxidant and metal dust were loaded separately in coaxial cylinders was started. Such a configuration appeared to offer the possibility of safety from impact initiation, and also of producing the high peak candlepower of the flashpowder bomb, along with the broad peak associated with the metal dust-type photoflash bomb. No photoflash bombs of this type were standardized. Results obtained with some experimental segregated oxidant bombs are summarized in Table 6-20.

#### 6-4.1.3 Other Photographic Illuminant Systems

Attempts have been made to increase the output of the standard flash bulb by a factor of 100 so that it could be used as a night aerial photographic illuminant. Unfortunately, it was found that this increase could not be obtained without incurring

TABLE 6-16  
DESIGNATION AND DESCRIPTION OF PHOTOFLASH CARTRIDGES

Cartridge Designation	Size, in. L × Dia	Total Weight, lb	Powder		Peak Intensity, 10 <sup>6</sup> Candles	Time to Peak, msec	Integral Light, 10 <sup>6</sup> Candlesecs		Duration of Flash, msec	Casing	Fuze		
			oz	Formula			CPS Total	Best CPS <sub>40</sub>					
				Type								Class	
T10	7.71×1.56	—	5.25	II	B	24	5	0.77	—	—	Standard M11 Signal case	Time delay 1 to 5 sec	
T12	7.73×1.57	0.72	5.75	I	II	B	50	5	1	—	30	Modified M11	Time delay 1,2, or 4 sec
M112	7.73×1.57	1	7	III	A	110	3	1.4	—	—	30	Modified M11	Time delay 1,2, or 4 sec
M123 (T89)	8.37×2.9	7	27.2	III	A	240	4	5	4.8	—	40	Al	Obtured delay fuze, 2.4, or 6 sec
T90	About same as M112	About same as M112	—	Each star: (b) NaNO <sub>3</sub> /atomized Mg binder, 30/70/2		8.6	—	2.5	—	—	690	outer case similar to M112; contains 5 stars	Obtured delay fuze, 1 or 2 sec
T102	8×1.75	1.25	12	III	A	169	4	2.4	—	—	31(a)	Al, 0.051 in. wall	Obtured delay fuze similar to M123
T103	11×2.375	5.5	27.2	III	A	325	4	7.2	6.6	—	47(a)	Al, 0.051 in. wall	Similar to M123

(a) to 0.1 max.

(b) Contains a high intensity illuminating composition, not photoflash powder.

disadvantages which essentially nullified any gain in output.

Other pyrotechnic light sources have been tried which were designed to produce illumination on a continuous basis rather than in short bursts for use with strip-type cameras which do not contain a shutter. The film is moved continuously across a slit at a speed which matches that of the image motion. One of the early attempts was the use of the T90 photoflare cartridge. This consisted of the same casing as the M112 with a charge of five stars which were made of a high intensity consolidated illuminating composition. The light output was not adequate as no visible image was obtained on the negatives exposed in flight test at 1000 feet.<sup>54</sup> Another attempt was a burner for magnesium dust which was developed for use on aircraft.<sup>55,56</sup>

#### 6-4.2 SPOTTING CHARGES

Spotting charges are used for locating point of impact, for target acquisition, for tracking, and for indication of item or component functioning. For many years, spotting charges of black powder were used in practice bombs and projectiles to locate point of impact. Because the observation distances were relatively short and because a relatively large volume was available for the spotting charge, an adequate flash could be produced with black powder. The development of long range missiles,

as well as the use of small arm projectiles as spotting rounds for major caliber weapons, led to a requirement for more effective spotting charges.

##### 6-4.2.1 Small Arm Spotting Rounds

Small caliber spotting rounds can be used to aim a major caliber weapon. In operation, the small caliber spotting rifle, which is rigidly attached to the main weapon, is fixed and the point of impact is indicated by a flash of light and a puff of smoke formed by the functioning of the small caliber spotting projectile. As the trajectory of the small arm spotting projectile and that of the main round are nearly identical at the critical range, the burst provides information for adjustment of aim. A hit with the spotting round means that the main projectile will also strike close to the target.<sup>57,58</sup>

A typical 20 mm spotting round is shown in Figure 6-39. This round contains about 6.5 cubic centimeters of a flash mixture and can produce a flash of 1.5 million candlepower with a duration of 700 milliseconds.

##### 6-4.2.2 Tracking

Highly accurate trajectory information is required in the development of a missile system. One method of obtaining this information for a missile at high altitudes is to photograph the flash

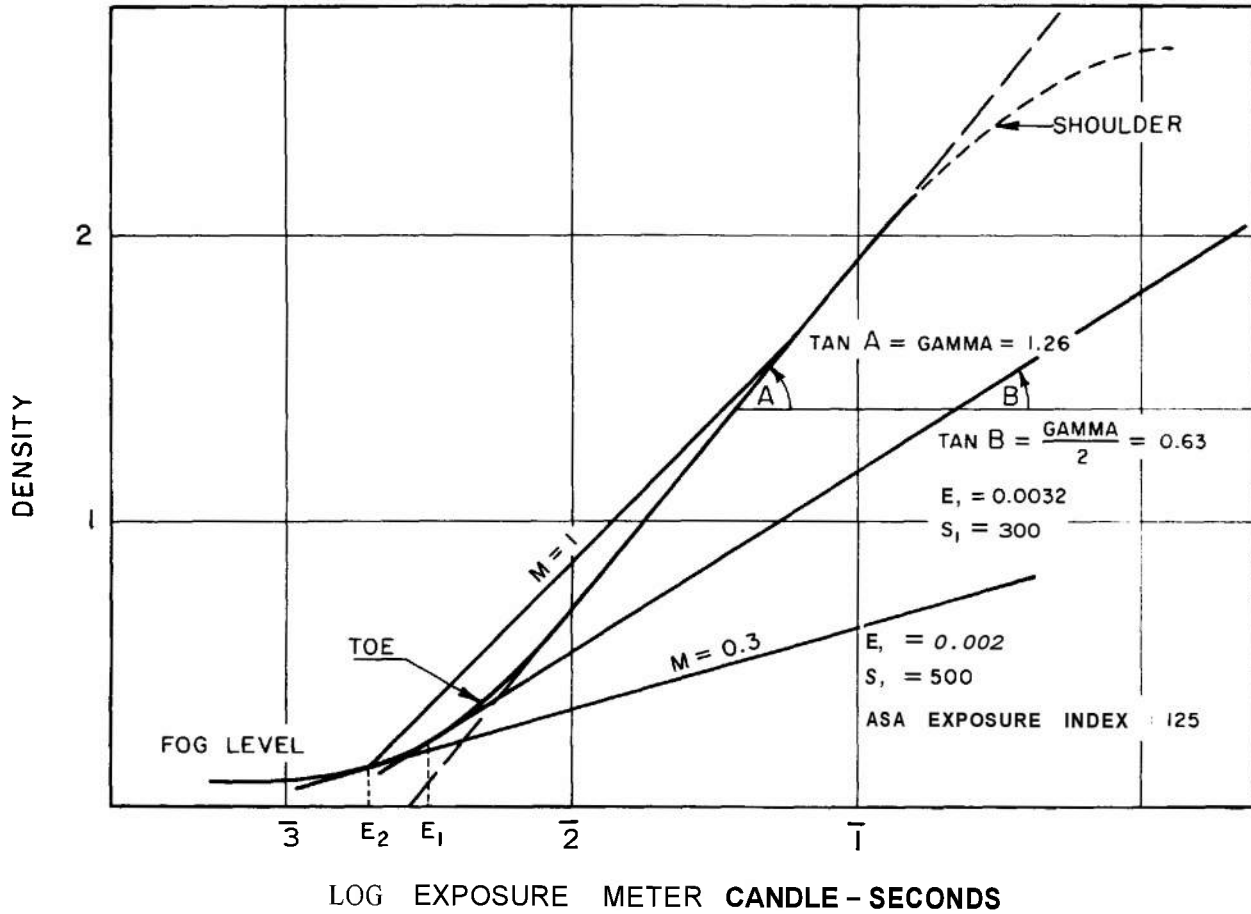

Figure 6-36. Typical Characteristics of Black and White Negative Material

produced by a photoflash cartridge ejected a distance sufficient to prevent damage to the missile in flight. Flash cartridges of the type shown in Figure 6-40 (which are of the same general type discussed in Paragraph 6-4.1.1) were developed for this purpose. Modifications to reduce weight and simplify mounting problems resulted in a flash device which produces a series of flashes with a known time interval between them.<sup>59</sup>

**6-4.2.3 Indication of Functioning**

Flash charges are used also to provide a visible indication of the functioning of an item or component such as a warhead fuze. The flash signal provides a brilliant light flash and can be photographically recorded by remote cameras, providing data so that the time and location of functioning

can be accurately determined.<sup>60,61</sup> A typical flash charge for this purpose is shown in Figure 6-41.

**6-4.3 TYPICAL COMPOSITIONS**

Typical nonconsolidated illuminating compositions used as photoflash and spotting charges are summarized in Table 6-21.

**6-4.4 Light Production**

As has been indicated, nonconsolidated illuminants differ from consolidated illuminants in the manner in which they react to produce light. Consolidated compositions propagatively burn in a relatively slow manner while nonconsolidated compositions react rapidly producing a bright flash of light. Because of the rapidity of the reaction, functioning of devices containing noncon-

**TABLE 6-17**  
**CHARACTERISTICS OF TYPE III PHOTOFLASH COMPOSITION**

<i>Ingredients :</i>	<i>Specification</i>	<i>Microns</i>	<i>Percent</i>
Aluminum, atomized	JAN-A-289	15	40
Potassium Perchlorate	PA-PD-254	24	30
Barium Nitrate	PA-PD-253	147	30
<i>Physico-Chemical Data:</i>			
Heat of Reaction, cal/g—2774 (calc)			
Reaction Temperature, °C—approx. 3500			
<del>Gas</del> Volume, cc/g—24 (calc)			
Tapped—1.67			
Vac. Stab, 120°C, cc gas/40 hrs—0.16			
<i>Sensitivity Data :</i>			
Impact :	PA, inches—40+		
Friction Pend :	Steel—Crackles; Fiber—No Action		
Ignition Temp, °C:	5 sec value—610; DTA—No Ignition		
Hygroscopicity :	57% RH, room temp; Hrs 24; % Wt Gain < 0.1		
Electrostatic			
Sensitivity :	Joule, Min 2.14; 50% Pt—3.5; 100% Pt—4.5 Temp—65 °F; % RH—40; Unconfined—Yes		

solidated illuminants can cause disruptive effects in their surroundings similar to the effects produced by high explosives.

#### 6-4.4.1 Light Output Characteristics

The light produced by the functioning of a device containing a nonconsolidated illuminant is characterized by its relative high peak intensity and the relatively short flash duration.

##### 6-4.4.1.1 Time Intensity<sup>62,63</sup>

A typical time-intensity curve for the light produced by the functioning of a photoflash device containing a flash powder (intimate mixture of powdered metal and oxidant) charge is shown in Figure 6-42. The curve for most spotting charges would be similar. As indicated in this figure, the important characteristics of the light output of a photoflash device are: (1) total amount of light produced (candleseconds), (2) amount of light produced in the best 40 milliseconds, CPS<sub>40</sub> (candleseconds), (3) peak intensity (candles), (4) time to peak intensity (milliseconds), and (5) du-

ration of the flash (milliseconds). The total amount of light produced determines the maximum exposure which can be obtained at any altitude, using open shutter techniques where the duration of the flash determines the exposure time. Unless image movement compensation techniques are used, the speed of the aircraft must be low enough that image relative movement will not result in unacceptable photographic definition. Until the development of image motion compensation techniques, many night aerial photographs were made with an exposure time of 1/25 second (40 milliseconds). In this case, the exposure obtained depended on the amount of light produced in 40 milliseconds, and the maximum photographic exposure was obtained with the shutter open for the best 40 milliseconds. (See Figure 6-43.) Peak candlepower is important as it greatly influences the amount of light produced in the best 40 milliseconds. The time-to-peak, and the variation in the time-to-peak are important for synchronization of the shutter open time and the best 40 milliseconds of the light flash.

Dust-type photoflash devices produce flashes

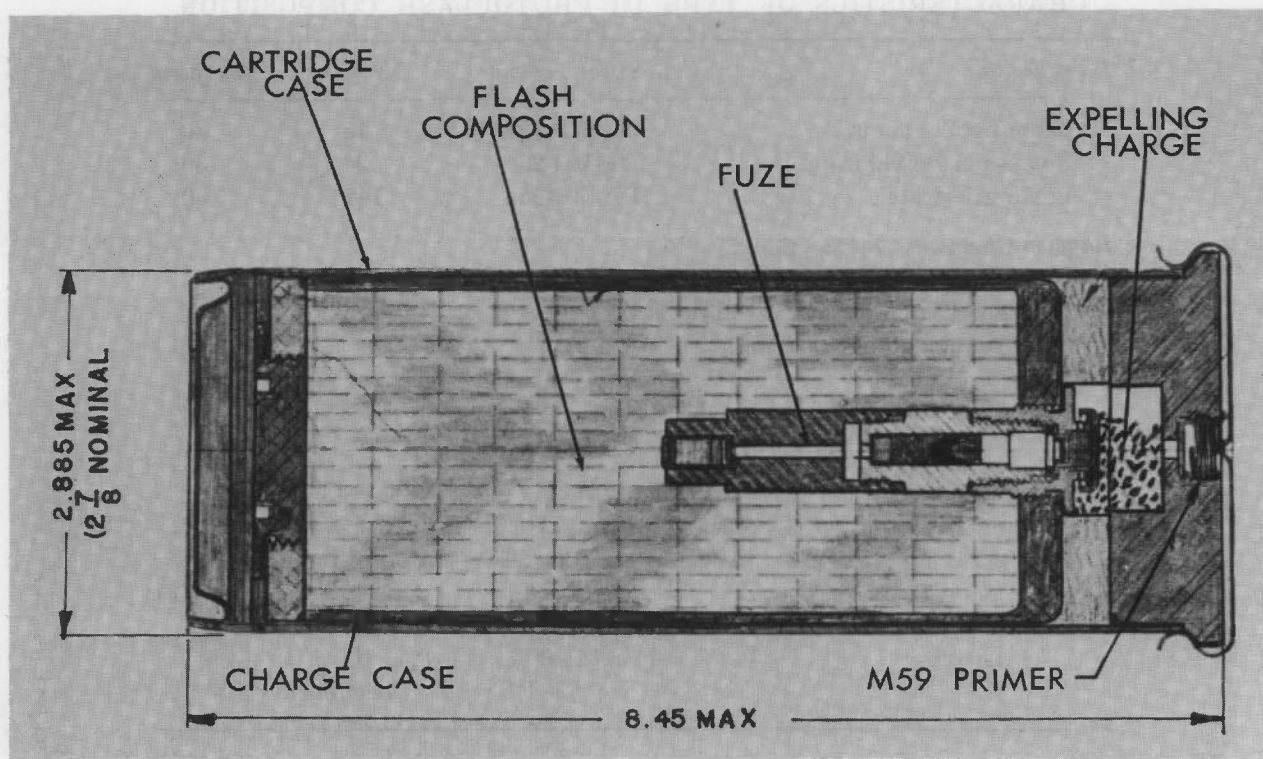

Figure 6-37. Typical Photoflash Cartridge

which have lower peak intensities and longer durations than those produced by devices containing flash powders, as shown in Figure 6-44. Image compensation techniques are normally required when dust-type photoflash bombs are used in order to efficiently utilize the light produced.

#### 6-4.4.1.2 Spectral Distribution

As shown in Figure 6-45, the spectral distribution curve of the light produced by a photoflash device consists of an intense continuous background on which a discrete spectra is superimposed.<sup>64</sup> The spectral distribution of the radiation produced by a dust-type photoflash bomb is similar.

While the more efficient photoflash compositions at low altitudes produce light which is mainly continuous, the more efficient compositions at high altitudes (100,000 feet) are those which produce an extensive discrete spectra in the visible.<sup>65,66</sup> (See also Paragraph 6-4.5.)

#### 6-4.4.2 Nature of the Photoflash Burst<sup>67,68</sup>

The light-producing characteristics of a flash item depend principally (as discussed in greater detail in Paragraph 6-4.5) on the composition, the amount and shape of the explosive which is used to initiate the composition, and the case. Flash radiographic studies show that when a relatively small amount of high explosive—centrally located in a case containing photoflash powder or metal dust—functions, a bubble of explosion products is formed in the first few microseconds of the initiation of the explosive. The shape of this bubble and the rate at which it expands are dependent on the properties of the material surrounding it, as well as that of the explosive initiator. For example, the shape of the bubble produced by a small quantity of explosive in flake aluminum which has a low density tends to be influenced more by the nature of the explosive and its confinement than the bubble produced in an-

**TABLE 6-18**  
**DESIGNATIONS AND DESCRIPTIONS OF FLASH POWDER PHOTOFLASH BOMBS**

Bomb Designation	Size, in. L × Dia.	Total Wt, lb	Powder		Peak Intensity, 10 <sup>6</sup> Candles	Time to Peak, msec	Integral Light			Casing	
			Wt, lb	Formula			CPS Total	Best CPS <sub>40</sub>	msec to 0.1 max.		
				Type							Class
M12 (T1)	32×7.25	32	25	I	—	325	10	—	—	250 <sup>(a)</sup>	Paper tube divided into 2 compartments; powder filled 4/5 of volume; plywood partition; 2 grenade fuzes and parachute in 1/5
M23 (T2)	25×4.25										
M46 (T3)	48×8	50	25	II	A,B	770	18	50	26	140	Inner fiber charge container; outer steel case 0.03 in. wall
T4	Enlarged M46	—	50	II	B	970	20	65	36.4 <sup>(c)</sup>	—	Light weight sheet metal case, powder in fiber container
T5	Enlarged M46	—	100	II	A	1670	20	132	71.5 <sup>(c)</sup>	—	Light weight sheet metal case, powder in fiber container
T6 (M60)	31.72×4.92	25	10	II	B	300	11	15.4	8 <sup>(c)</sup>	—	0.0239-in. wall. Thin metal case
T6E1						—	—	—	—	—	0.026-in. wall
T6E2						—	—	—	—	—	—
NDRC Types 1-8	58×10.75	200	80 to 88	Various		Best 1700 <sup>(b)</sup>	15 <sup>(b)</sup>	118 <sup>(b)</sup>	Best 60.5 <sup>(b,c)</sup>	—	250-lb T1 casing
T8	36×8	145	70	II	B	850	2	99	30	270	125-lb demolition bomb, case, 0.19 in. wall
T8E1		115	35	II	B	—	—	—	—	—	
T8E4-6		—	—	—	Various		—	—	—	—	
T9E8	35×8	166	70	III	A	2100	5	140	65	153	M70; 0.19-in. wall
M120	52.25×8	150	70	III	A	3490	6	165	75.6	153	Modified M70 chemical bomb body, box type fin, 0.188-in. wall
M120 III B	52.25×8	165	85	III	A	4490	6	223	95.9	188	Same as M120
T92	39×11	280	138	III	B	5840	5	290	140.5	226	Optimum design to fit in RB-4 aircraft; shallow, wide fin
T93	59.16X14.18	496	224	III	A	4000	5	373	108	255	500-lb G.P. bomb casing, AN-M46; M109 fin assembly
T94	69.5×18.8	926	450	III	A	5600	65	666	163	299	1000-lb G.P. bomb casing AN-M65
T99	4.25 or 13		70	—	—	—	—	—	—	42	—
T104			or 104 (thin case)	III	B	(End on)	4	189	82	163	Modified M30A1 100-lb G.P. bomb body; or thin case model, modified M47A3 chemical bomb body
						2900					

(a) Total duration

(b) With Type II, Class B powder

(c) During 0-50 msec

odized aluminum. The subsequent shape of the bubble in the metal dust depends on the resistance encountered in different directions. If the confining case deforms slowly without rupture, the shape of the explosion products will tend toward the shape of the deformed case. If the case ruptures quickly at one point, the dust may be forced through this opening while some of the dust will remain in the case. For small quantities of explosive, the shape of the explosive is of little importance. For larger quantities of explosive, the shape and its method of initiation must be considered. An extreme example is an end-initiated line charge axially located in a surrounding cyl-

inder of metal dust. In all cases initiation and burning of the dust takes place in the air after case breakup.

If the surrounding material can react rapidly, gases resulting from the vaporization of the reactive material at the outer surface of the expanding bubble of explosive products will increase the rate at which the bubble expands. The amount of this contribution depends on the reactivity of the mixture. The piston action of the expanding bubble forms a spherical shell of compressed flash composition. Rapid chemical reaction starts at the shock front when it reaches the case and the increase in pressure results in case rupture. After

**TABLE 6-19**  
**CHARACTERISTICS OF DUST PHOTOFLASH BOMBS**

Bomb Designation	Size, in. L×Dia	Total Wt, lb	Powder		Peak Intensity, 10 <sup>6</sup> Candles	Time to Peak, msec	Integral Light 10 <sup>6</sup> Candlesecs		Altitude Flown, ft	Burst Altitude and Position, J	Duration of Flash, msec to 0.1 maz	Casing	Burst
			Wt, lb	Formula			CPS Total	Best CPS <sub>40</sub>					
T7	46.72×8	65(?)	39	Mg, Grade B	—	—	—	—	—	—	Modified M46 case with dust charge		
T8	40×10.76	200	70	Flake Mg, Grade B	41	44	9	1.9(*)			Modified 250-lb AN-M57 G. P. Bomb case, 0.3-in wall	Tetryl; conical; tinplate container	
T8E1		150	35	Flake Al, Grade A	1100	10	49.4	35.1					
T9E2	36×8	103	17	Flake Al	42	—	39	—			125-lb demolition bomb case, 0.19-in. wall	Tritonal 5 lb	
T9E3	36×8	125	40	Pigment Al/S, 75/25	38	—	45	—			Same as T9E2		
T9E7	35×8		52	Atomized Mg	650	14	20	—			Sheet steel, 0.06 in. wall; casing/burster diam. ratio: 4:1	2 in. diameter each: Tritonal 5.8-lb Sodato 6.1-lb Tritonal 5.8-lb Sodato 16.1-lb Tritonal 5.8-lb Sodato 16.1-lb	
Type 1			52	Atomized Mg	600	13	20	—					
2			60	Atomized Mg-Al alloy	1300	13	30	—					
3			60	Atomized Mg-Al alloy	1200	15	25	—					
4			21	Flake Al	750	13	25	—					
5			21	Flake Al	550	14	20	—					
6													
T86 (Ballistic Design)	66×8	100(?)	55	—	—	—	—	—			0.2-in. case thickness	—	
T86E1-4	35×8 35×10 20×11 24×12	85	70	Various metal dusts	Varied: 1400-2450	Varied: 34-121	Varied 164.5-660	Varied: 50-94	25,000-35,000	5,000-15,000	119-812	Various	Various
M122 (T86E2)	54×8	110	75	Atomized 65/35 Mg-Al alloy (20±5 microns)	820	50	—	31.9	5,000-20,000	8,000; 30° trail angle best	—	—	M26, 1-in. diam. cylindrical; 2-lb cast 70/30 tritonal; M147E1 fuze
T86E5	13 diam.	—	—	Atomized Al	—	—	—	—			Thin Al or steel	TNT and booster	
0-69	27.5×4	18	9.5	Al dust and KClO <sub>4</sub> segregated	672	28	—	20.2			82	Concentric burster, oxidant, metal dust tubes	Hand packed TNT; Tetryl booster; M146 fuze
0-70	48.6×8	96	70	Same as 0-69	Best, 3490	42	—	Best, 130	To 30,000	At least 13,000; 30° trail	—	M46 case adapted to concentric loading	Hand packed TNT; Tetryl booster; M146 fuze
T115	54×8	110	84	Same as 0-69	Best, 1470	28	—	Best, 48.9	To 30,000	At least 13,000 30" trail single best	—	Modified M47A3 chem. bomb case	Larger than 0-70 burster
X52	39×10	175	114.2	Same as 0-69	Best, 4890	—	—	160			—	Concentric casing, specially designed	Hand tamped crystalline 2-in. TNT, 4-lb; Tail fuze
x53	22×8	50	34.3	Al with 3% SiO <sub>2</sub> gel, KClO <sub>4</sub>	—	—	—	—			—	Concentric casing, specially designed	1.7-lb hand tamped TNT, Tetryl booster; Tail fuze

(\*)During 0-50 msec

TABLE 6-20  
SEGREGATED OXIDANT PHOTOFLASH BOMBS

Bomb Designation	Size in. L×Dia.	Total Weight, lb	Powder		Central Burster	Peak Intensity, 10° Candles	Integral Light 10° Candlesecs. Best 40ms. Period
				Inner Shell			
0-69	4×27.5	18	8.4 lb Al dust	3.1 lb KClO <sub>4</sub>	TNT burster	672	20.2
0-70	M46 casing	96	Al dust 70 lb total chg.	KClO <sub>4</sub>	TNT	3490	130
T115	M47A3 Chemical bomb case	110	Al dust. 84 lb total chg.	KClO <sub>4</sub>	TNT	1470	48.9
X52	10×30	175	Atomized Al 78 lb	36 lb KClO <sub>4</sub>	TNT	4890	130
x 53	8×22	50	Atomized Al 25 lb-3% silica gel	12 lb KClO <sub>4</sub>	TNT	2200 (expected)	74 (expected)

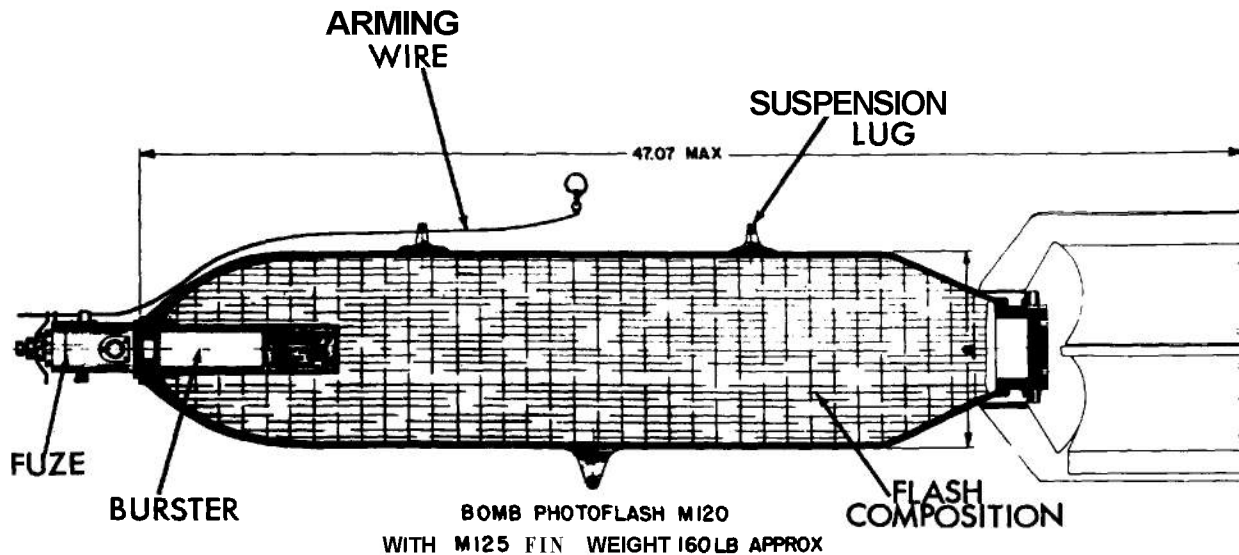

Figure 6-38. Typical Photoflash Bomb

case rupture the cloud expands against the atmospheric pressure, resulting in cooling of the cloud. The cloud must contain fairly large sized particle aggregates (approximately 250 microns)<sup>18</sup> so as to reach the size observed experimentally. The light output reaches a peak value and then slowly decreases.

#### 6-4.5 FACTORS AFFECTING PERFORMANCE

The light output of bright flash-producing devices is dependent upon many interrelated factors.

Some of the more important of these factors are: (1) charge weight, (2) composition, (3) particle size, (4) burst diameter and shape, (5) igniters and bursters, (6) confinement, and (7) ambient pressure.

##### 6-4.5.1 Charge Weight

Generally, flash powder in items which produce a burst approaching a spherical shape (see also Paragraph 6-4.5.4) develop a total light output which is proportional to the charge weight (as is



**TABLE 6-21**  
**TYPICAL COMPOSITIONS FOR PHOTOFFLASH AND SPOTTING CHARGES**

<i>Type</i>	<i>Class</i>	<i>Nominal Composition</i>	<i>Remarks</i>
<i>PHOTOFLASH POWDERS</i>			
I	—	34% Magnesium 26% Aluminum 40% Potassium Perchlorate	Used at start of World War II in M46 Photoflash Bomb
II	A	60% 50/50 Magnesium-Aluminum Alloy 40% Potassium Perchlorate	Developed because of shortages at start of World War II of Aluminum and Magnesium Powder
	B	45.5% 50/50 Magnesium-Aluminum Alloy 54.5% Barium Nitrate	Later development led to substitution of Barium Nitrate for Potassium Perchlorate
III	A	40% Aluminum, Class C 30% Potassium Perchlorate 30% Barium Nitrate	
	B	Same as 111-A except that the Potassium Perchlorate is coarser	
IV	—	80% Calcium 20% Sodium Perchlorate	Experimental Efficiency at 100,000 feet is $45.7 \times 10^3$ candlesec/g
<i>SPOTTING CHARGES</i>			
—	—	30% Atomized Aluminum 10% Flake Aluminum 60% Barium Nitrate	Developed to give short time to peak but with less brisance than photoflash powders

the light produced in the best 40 milliseconds,  $CPS_{40}$ ). The duration of the flash increases as the cube root of the charge weight; while the peak intensity increases as the two-thirds power of the charge weight.<sup>69,70,71</sup> The efficiency and light output for a given weight of charge, therefore, decrease with charge weight.

#### 6-4.5.2 Composition

As indicated in Table 6-22,<sup>66</sup> aluminum and magnesium are the best fuels for use in photoflash mixtures at low altitudes.<sup>18,72</sup> While atomized magnesium gives higher luminous intensities than other fuels in consolidated illuminating compositions, it has been found that atomized aluminum

gives better results in nonconsolidated illuminating compositions.

Thermodynamic data for stoichiometric mixtures of aluminum and various oxidizing agents are given in Table 6-23.<sup>73</sup> The trend is similar to that for consolidated illuminants. (See Paragraph 6-3.5.1.) As the molecular weight of the oxidant increases, the aluminum content of the stoichiometric mixture decreases so that the heat of reaction also decreases. Of the oxidizers listed in this table, potassium perchlorate produces the highest heat of reaction with atomized aluminum. Luminosity values for various nitrates with atomized aluminum and atomized magnesium are given in Table 6-24. As indicated by this table, which is

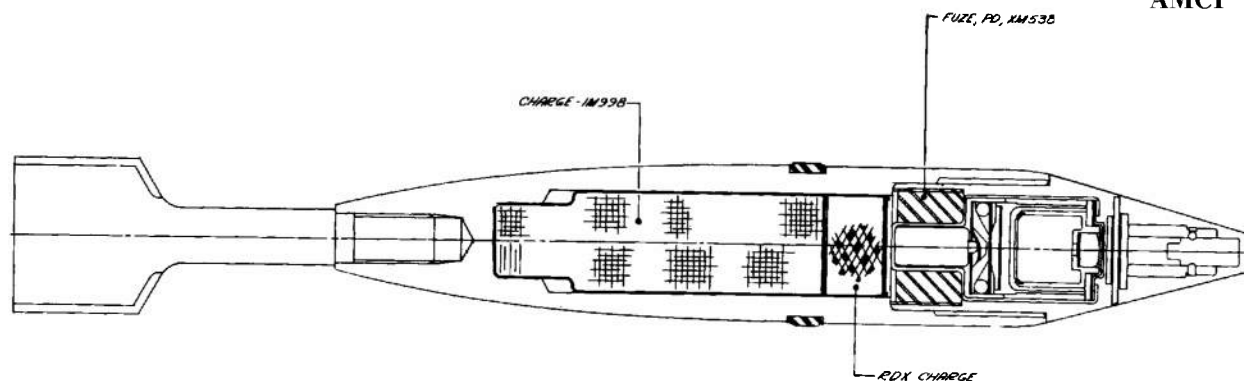

### XM101 Spotting Projectile

Figure 6-39. Typical 20 mm Spotting Round

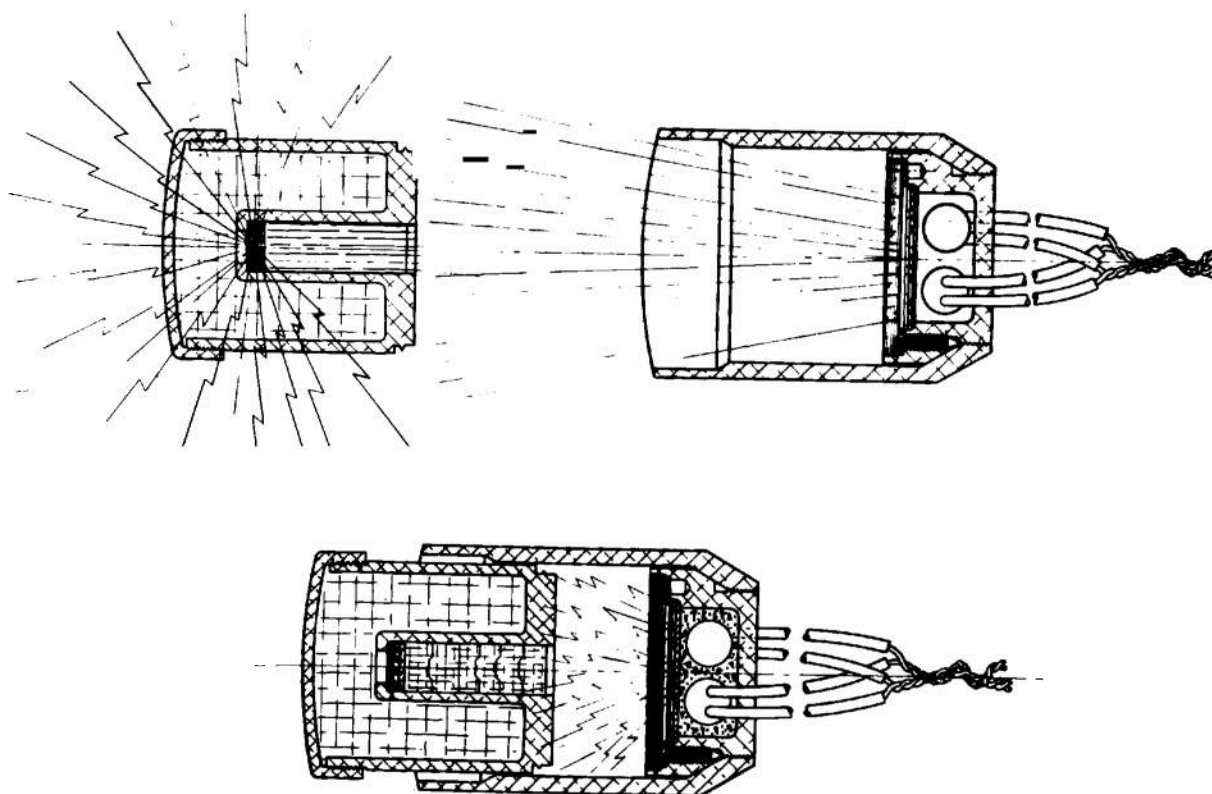

Figure 6-40. Photoflash "Daisy" Cartridge

for fuel-rich compositions, the light output of stoichiometric mixtures are relatively low; and alkaline earth metal nitrates are much more satisfactory than alkali metal nitrates in nonconsolidated illuminating compositions.

For dust-type bombs, there are marked differences in behavior of flake aluminum, atomized mag-

nesium, and atomized magnesium-aluminum alloys. Atomized aluminum is difficult to ignite and has not been used efficiently in metal dust photoflash bombs. Flake aluminum, which requires a weight of burster approximately equal to that of the dust, produces a flash of relatively short duration and a rapid time to peak. Atomized mag-

**TABLE 6-22**  
**LUMINOSITY CHARACTERISTICS AT SEA LEVEL OF PHOTOFASH COMPOSITIONS**  
**CONSISTING OF HIGH-ENERGY FUELS IN STOICHIOMETRIC AND FUEL-RICH**  
**COMBINATIONS WITH POTASSIUM PERCHLORATE**

Fuel	Type of Composition(*)	Peak, 10 <sup>6</sup> candles	Time to Peak, msec	Integral Light, 10 <sup>3</sup> candlesec, (1/10 max)	Duration, msec		Efficiency, 10 <sup>3</sup> candlesec/g Fuel	Increase in Efficiency, %
					1/10 max	Total		
Aluminum	S	41	1.2	147	9	14	10.3	35
	X	41	1.7	226	11	16	13.8	
Magnesium	S	18	1.2	142	16	24	10.0	15
	X	20	2.3	189	17	25	11.5	
Zirconium	S	38	0.7	92	7	14	2.8	147
	X	55	0.9	278	11	23	6.9	
Titanium	S	18	0.4	65	9	15	4.9	4
	X	16	1.3	80	12	21	5.1	
Calcium	S	12	1.2	75	13	16	5.7	30
	X	13	1.7	115	15	19	7.4	
Boron	S	0.5	23.0	18	68	89	3.5	85
	X	2	14.3	51	55	92	8.5	
Silicon	S			Did not ignite				
	X			Did not ignite				

(a) S = Stoichiometric, X = 14% excess fuel.

nesium, which requires a much smaller burster, gives a flash of much longer duration and has a longer time to peak. The magnesium alloys are intermediate in their behavior. The difference in the metal dust-to-burster ratio may be due to the relative ignitability of the metal fuels. Powdered magnesium is easier to ignite than powdered aluminum; as a consequence, atomized aluminum has not been used efficiently in a metal dust bomb. The longer time to peak and flash duration of magnesium can be explained by the reaction between magnesium and nitrogen which precedes the reaction with oxygen.

Small amounts of additives, principally metals and silica gels, have been tried to increase the light output from photoflash devices. Results, in gen-

eral, indicate that these additives do not increase the output of those photoflash items which are near optimum. Conflicting results have been obtained. Some earlier investigators obtained results which indicated improvement with some additives.<sup>18</sup>

#### 6-4.5.3 Particle Size

Much of the research and development concerning photoflash compositions has centered around the determination of the optimum particle size and shape. While it has long been known that the average particle size and particle size range are important parameters in determining the luminosity characteristics of pyrotechnic flash mixtures,<sup>18</sup> detailed relationships were difficult to establish until methods became available to classify

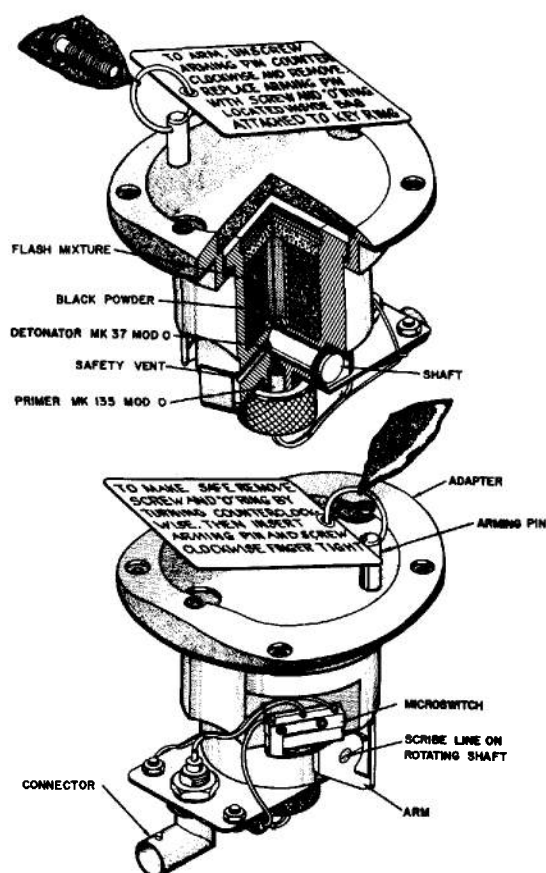

Figure 6-47. Typical Plush Charge for "Indication of Functioning"

TABLE 6-23  
THERMODYNAMIC DATA FOR STOICHIOMETRIC MIXTURES OF OXIDIZING AGENTS AND ATOMIZED ALUMINUM

	Stoichiometric Ratio	Calculated Heat of Reaction, Cal/g
Sodium nitrate	65.4/34.6	1955
Potassium nitrate	69.2/30.8	1766
Strontium nitrate	70.2/29.8	1899
Barium nitrate	74.4/25.6	1598
Potassium perchlorate	65.8/34.2	2529

the fuel and oxidant powders into narrow particle size ranges.

For potassium perchlorate-aluminum (60/40 by weight) flash compositions, it was found that only

systems in which the aluminum was in the  $22 \pm 8$  micron particle size range would produce enough light for pyrotechnic applications.<sup>74</sup> Regardless of the oxidizer size, system containing coarser aluminum —8.4-40 microns and 24-62 microns—did not produce a usable amount of light. When the aluminum particle size was held constant, decreasing the oxidant particle size resulted in an increased efficiency (candle seconds per gram) at both sea level and at 80,000 feet simulated altitude. (See Figure 6-46.) At high altitude, the peak and integral light intensity vary similarly. At sea level, however, the composition with the coarse oxidizer produced the highest peak and integral light intensity, due to the greater tapped density with the coarse oxidizer fraction, so that a greater sample weight could be loaded into the test cartridge.

The marked differences in the behavior of the dusts used in dust-type photoflash bombs (Paragraph 6-4.5.2) result in the existence of an optimum particle size for each metal or alloy and each method of dispersion.<sup>73</sup> Excessively large particles will not ignite after dispersal. Efficiency tends to decrease, in the case of magnesium and magnesium-aluminum alloys, if there is too large a percentage of fines in the dust. As a consequence, the use of "run of the mill," less than 100 mesh, atomized magnesium is preferable to the use of mixtures containing a large amount of 325 mesh fine particles.<sup>18</sup>

In order for the diameter of the burst produced by dust-type photoflash bombs to be as large as observed experimentally, calculations indicate that the metal dust particles must "clump" together (possibly due to the pressure produced by the explosive burster) in fairly large particles, at least 250 microns in diameter. These "clumps," due to air-drag breakup as they move through the air, leave small particles (particles having the initial size distribution of the metal dust) which burn in the air.<sup>18</sup>

#### 6-4.5.4 Cloud Shape

Since most photoflash bursts are essentially spherical in shape and essentially opaque to visible radiation, the amount of light radiated is proportional to the square of the burst radius, provided,

**TABLE 6-24**  
**LUMINOSITY VALUES OF VARIOUS OXIDANTS WITH ATOMIZED**  
**ALUMINUM AND ATOMIZED MAGNESIUM TESTED**  
**IN M112 PHOTOFLASH CARTRIDGE**

<i>Oxidant</i>	<i>Peak Intensity, 10<sup>6</sup> Candles</i>	<i>Time to Peak, msec</i>	<i>Total Integral Light, 10<sup>6</sup> Candle-Seconds</i>
<i>Aluminum Compositions</i>			
Sodium nitrate		Burned without detonation	
Potassium nitrate		Burned without detonation	
Strontium nitrate	124	3	1.61
Barium nitrate	139	3	1.64
<i>Magnesium Compositions</i>			
Sodium nitrate	4	—	—
Potassium nitrate		Failed to ignite	
Strontium nitrate	21	5	0.33
Barium nitrate	42	5	0.65

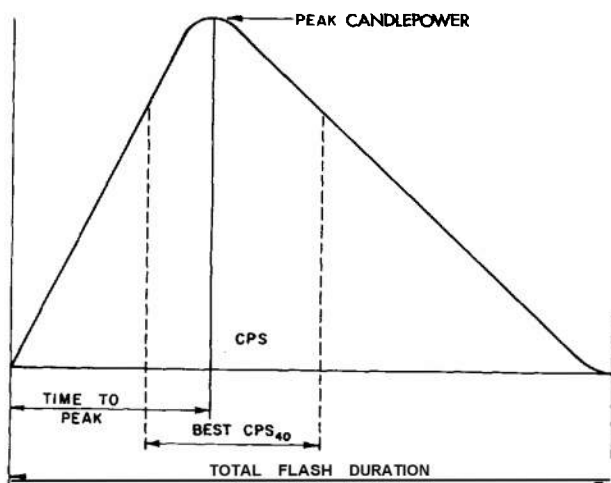

**Figure 6-42. Typical Time-Intensity Curve**

the temperature of the surface of the burst remains constant. Since the volume of the sphere is proportional to the charge weight, and the maximum temperature is limited to about 3000°C, the peak intensity should, as has been verified experimentally (Paragraph 6-4.5.1), vary as the charge weight to the two-thirds power. The efficiency of the larger charges is, therefore, less than that of the smaller charges but could be increased con-

siderably by enlarging the effective surface area of the burst. Theoretically, an optimum system, as long as the temperature remains high, consists of an infinite number of infinitesimally small point sources.<sup>75</sup>

Line photoflash charges, as well as a large number of small photoflash charges have been attempted with some success. Both methods, which effectively increase the amount of radiating area for a given charge weight, are difficult to use practically.<sup>18</sup> As a result of recent improvements in aerial photographic techniques and equipment, which permit the utilization of light over longer periods of time (up to 250 milliseconds), pellets of pressed illuminating composition have been used in place of short duration photoflash charges. Results indicate that efficiencies are much greater than those obtained with photoflash compositions.<sup>75</sup>

#### 6-4.5.5 Bursters and Igniters

A great many explosives have been tried (Table 6-25) as bursters in dust-type photoflash bombs. In general, the most powerful or brisance buster seems to perform best. RDX is better than tetryl which, in turn, is better than TNT, other conditions being equal. Aluminized explosives at optimum

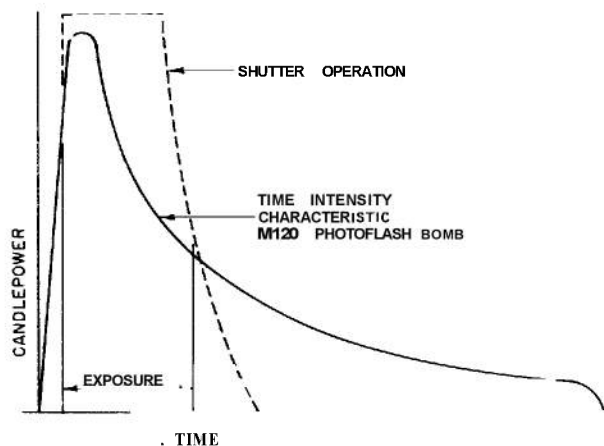

Figure 6-43. Synchronization of Shutter

concentrations have greater power than the pure explosive and, therefore, perform better as bursters.<sup>18</sup>

As has been indicated, there are marked differences in the behavior of flake aluminum, atomized magnesium, and atomized magnesium-aluminum alloys when dispersed and ignited as a dust cloud. Flake aluminum requires a weight of burster approximately equal to the weight of the metal dust. Atomized magnesium requires much less weight, approximately 1/100 of the weight of the metal dust.<sup>73</sup> The maximum radius of a magnesium dust flash depends, approximately, on the cube root of the dust-to-burster ratio for the lower ratios and on a somewhat lower power at the higher dust-to-burster ratios. At a constant dust-to-burster ratio, the radii of magnesium dust flashes increase, roughly, as the cube root of the quantity of dust. In general, for magnesium and magnesium-aluminum alloys, an increase in the dust-to-burster ratio results in an increase in time to peak, an increase in flash duration, along with an increase in integrated light values, and, to a lesser extent, an increase in light intensity. Because of the large amounts of burster required for flake aluminum, variations in the dust-to-burster ratio within the useful ranges seem to have little effect.

Other factors—including shape of the burster, loading techniques, and confinement—have been studied. Most dust-type bombs that have been studied use a cylindrical burster or a truncated cone. The method used to load a burster did not

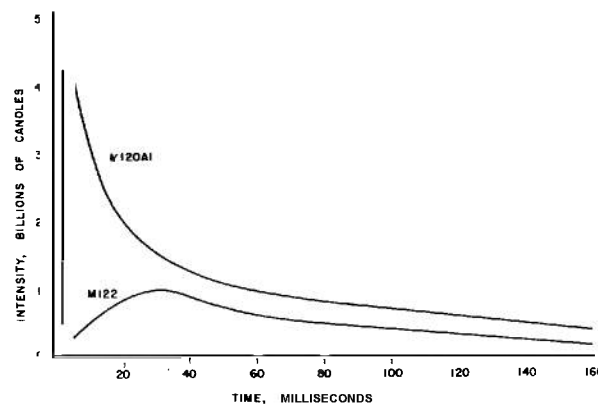

Figure 6-44. Time-Intensity Curves for M120A1 Flash Powder and M722 Dust Photoflash Bombs

appreciably influence the output of the dust bomb. Centrally located bursters, all factors considered, gave results comparable to those for any other location. The shape of a relatively small amount of explosive in an essentially nonreacting metal dust should have little influence except to change the center of the gas bubble formed. (See Paragraph 6-4.4.2.)<sup>68</sup>

For a reactive photoflash mixture where the reaction contributes to the growth of the gas bubble, the effect of location, shape, and amount of initiator are important. The use of an initiator too powerful for a particular case and composition might cause too rapid expansion of the gas bubble, resulting in case rupture before a desirable initiation of the photoflash mixture. For a long column of flash composition with an initiator in one end, a stage can be reached where reaction in the photoflash mix will propagate through the mixture resulting in some measure of independence from the mode of ignition.<sup>18,68</sup> During this process, the case must continue to maintain confinement in order to have adequate ignition of the balance of the photoflash mixture.

#### 6-4.5.6 Confinement

The characteristics of the case surrounding a reactive photoflash mixture affect the amount of time available for ignition of the mixture as well as the way the mixture is released and disseminated. A case of excessive strength, requiring an appreciable amount of energy to rupture, may divert

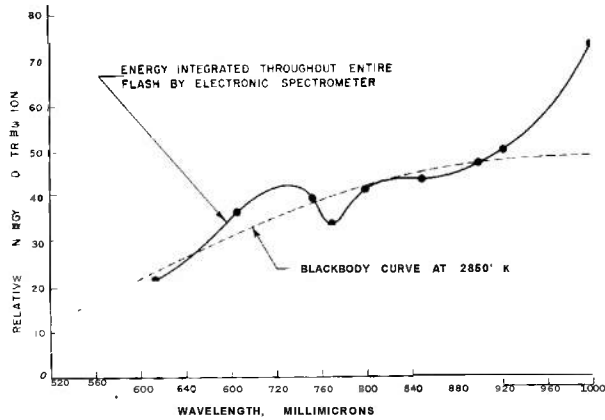

Figure 6-45. Spectral Energy Distribution Curve of M720 Photoflash Bomb

sufficient energy to reduce the light output. Too thin a case may allow the mixture to be released before adequate ignition has taken place, thus reducing the effectiveness of the flash. This effect, which would be emphasized at low ambient pressures, was illustrated in tests conducted with metal and plastic cases. With the metal case, the expected light output was obtained at ambient conditions and 80,000 feet and with the plastic case at ambient conditions; however, a sharp drop occurred for plastic cases at 80,000 feet. Variations in thickness within narrow limits for metal cases were found to cause negligible changes in light output.<sup>68</sup>

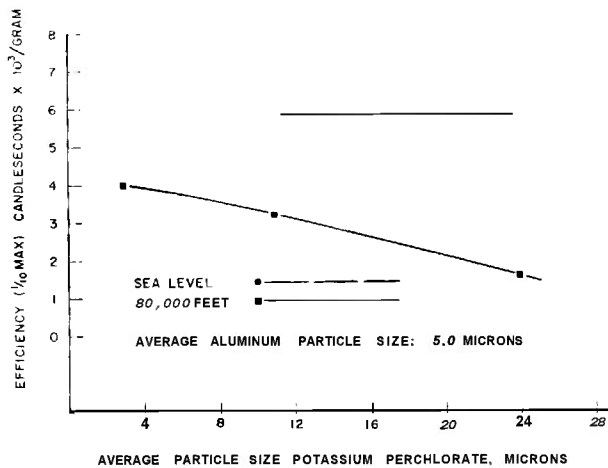

Figure 6-46. Effect of Particle Size of Potassium Perchlorate on Luminous Efficiency of 60/40 Potassium Perchlorate-Aluminum Compositions

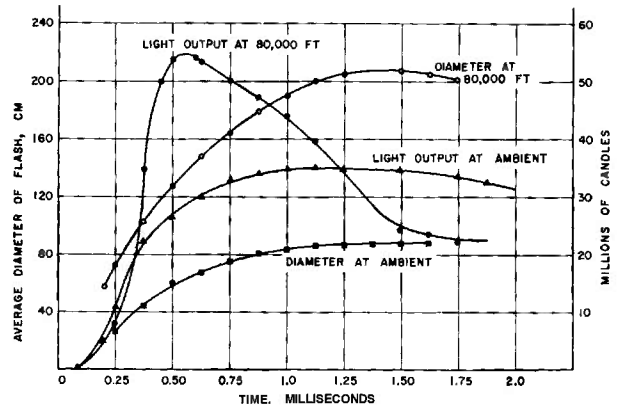

Figure 6-47. Size and light Output of Flash Cloud vs Time

TABLE 6-25  
HIGH EXPLOSIVES TRIED AS BURSTERS  
IN FLASH BOMBS

Nonmetallized	Metallized
Comp. A-3	Al/KClO <sub>4</sub> /cellulose nitrate,
Comp. C	49/49/2
Gunpowder	Comp. A-3/Al,80/20
Photoflash Powder	Comp. B/Al,80/20
Type III, Class C	HBX-3
Primacord	HBX-6
Pyrotechnic Compn.	Minol 2
RDX	RDX/Al/wax
RDX/TNT	RDX/TNT/Al,
RDX/TNT, 60/40	42/40/18 (TorpeX 2)
Sodatol	20/50/30
Tetryl	RDX/TNT/Al/Carbon,
Tetryl/TNT, 30/70	20/55/25/2.5
TNT	RDX/Al/PIB,
	78.5/20/1.5
	Tetryl/Al
	TNT/Al
	Pritonal: TNT/Al
	70/30
	75/25
	80/20

For dust-type photoflash bombs, the casing material has a relatively unimportant influence on the light output. The thickness of the case has a limited but not critical effect on the output, especially with large bursters.<sup>76,77</sup>

**TABLE 6-26**  
**LUMINOSITY CHARACTERISTICS OF PHOTOFLASH COMPOSITIONS CONSISTING OF**  
**HIGH-ENERGY FUELS IN STOICHIOMETRIC COMBINATION WITH**  
**POTASSIUM PERCHLORATE\***

Fuel	Composition Weight, g	Peak, 10 <sup>6</sup> candles	Time to Peak, msec	Integral Light, 10 <sup>3</sup> candlesec, (1/10 max)	Duration, msec		Efficiency, 10 <sup>3</sup> candlesec/g	
					1/10 max	Total	Composition	Fuel
<i>Sea Level</i>								
34% Aluminum	42	41	1.2	147	9	14	3.5	10.3
41% Magnesium	35	18	1.2	142	16	24	4.1	10.0
57% Zirconium	58	38	0.7	92	7	14	1.6	2.8
41% Titanium	33	18	0.4	65	9	15	2.0	4.9
58% Calcium	23	12	1.2	75	13	16	3.3	5.7
17% Boron	31	0.5	23.0	18	68	89	0.6	3.5
29% Silicon	35			Did not ignite				
<i>100,000 Feet</i>								
34% Aluminum	42	49	1.3	103	7	14	2.5	7.3
41% Magnesium	35	16	0.5	10	1.2	33	0.3	0.7
57% Zirconium	58	65	0.7	92	3	11	1.6	2.8
41% Titanium	33	29	0.6	49	4	13	1.5	3.7
58% Calcium	23	26	0.5	176	21	29	7.7	13.3
17% Boron	31			No deflection				
29% Silicon	35			Did not ignite				

\*Test vehicle, M112 charge case reduced to 1.72-inch length.

#### 6-4.5.7 Ambient Pressure

As indicated by the data in Table 6-26 the light output of most possible photoflash mixtures is less at an altitude of 80,000 feet than at sea level. Of the high energy fuels evaluated, aluminum and magnesium were most efficient at sea level and calcium was most efficient up to 100,000 feet.<sup>66</sup> As the boiling point and extent of dissociation of the reaction products depend on the ambient pressure, the final flash temperature will decrease with increasing altitude. The radiation produced by most photoflash items is continuous (see Paragraph 6-4.4.1.2) approaching that of a graybody with a high emissivity and lower light values obtained. Some compensation for this loss

of light results because the flash diameter at altitude (Figure 6-47) is greater than at sea level.<sup>68</sup>

The effectiveness of photoflash mixtures containing calcium depends on the formation and energy content of discrete bands.<sup>78</sup> The phenomenon of increasing light output observed with compositions containing calcium metal, calcium alloys, calcium perchlorate, and calcium nitrate also results when adding an inert calcium salt such as calcium oxide or calcium fluoride to a composition producing a high temperature such as aluminum-potassium perchlorate. The magnitude of the increase in light output, however, is considerably less than for other calcium-containing compositions.<sup>66</sup>



## REFERENCES

1. Alan St. H. Brock, *A History of Fireworks*, George G. Harrap and Co., Ltd., London.
2. Jean Appier (alias Hanzelet), *La Pyrotechnie*, Pont a Mousson, 1630 (quoted in Brock, *A History of Fireworks*).
3. Claude Ruggieri, "Elemens de Pyrotechnie," *Fortune*, Paris, 1801 and 1821 (quoted in Brock, *A History of Fireworks*).
4. Claude Ruggieri and Thomas Morel, "Die Pyrotechnie," *Nach der Vorschriften*, Leipzig, 1807 (quoted in Brock, *A History of Fireworks*).
5. Claude Ruggieri, "Pyrotechnie Militaire," *Fortune*, Paris, 1812 (quoted in Brock, *A History of Fireworks*).
6. James Cutbush, "Chinese Fire," *American Journal of Science*, VII, 1823 (quoted in Brock, *A History of Fireworks*).
7. Summary Technical Report, Vol. 2, Chapter 4, NDRC Division 11, National Defense Research Committee, Office of Scientific Research and Development, Washington, D. C.
8. D. Hart, *Research and Development Progress in Military Pyrotechnics*, Research and Development Lecture No. 24, Picatinny Arsenal, Dover, N. J., 1955 (DDC-AD 82 678).
9. T. Stevenson, E. R. Rechel, *Delay Action Tracer Ammunition*, Frankford Arsenal Report R-44, Frankford Arsenal, Philadelphia, Pa., 1940.
10. T. Stevenson, *Delay Action, and Dim Igniters for Small Arms Tracer Bullets*, Frankford Arsenal Report 708, Frankford Arsenal, Philadelphia, Pa., 1946.
11. *Develop, Manufacture and Test Flashlight Bombs*, Picatinny Arsenal Technical Report 803, Picatinny Arsenal, Dover, N. J., March 1937.
12. J. H. Robinson, *Investigation of Failures of M23 Photoflash Bombs*, Picatinny Arsenal Technical Report 1068, Picatinny Arsenal, Dover, N. J., January 1941.
13. H. J. Eppig, D. Hart, *Bomb, Photoflash, T9 Series: Development of Improved Photoflash Composition*, Picatinny Arsenal Technical Report 1758, Picatinny Arsenal, Dover, N. J., January 1950.
14. S. A. Richer, *The Photoflash Bomb*, Picatinny Arsenal, Dover, N. J., April 1955.
15. H. J. Eppig, D. Hart, *Bomb, Photoflash, T9 Series: A Study of Light Emission Characteristics of Safe, Dust Type Photoflash Bombs*, Picatinny Arsenal Technical Report, 1757, Picatinny Arsenal, Dover, N. J., February 1950.
16. S. A. Richer, *The Photoflash Cartridge*, Picatinny Arsenal, Dover, N. J., April 1955.
17. M. G. M. Clarke, *Development of the Photoflash Bomb*, ORDWES Report 1949-5, Wesleyan University, Middletown, Connecticut, April 1949.
18. *The Compilation of Flame and Shockwave Information Applicable to Photoflashes*, Final Summary Report, Contract DAI-28-017-501-ORD(P)-1096, Arthur D. Little, Inc., Cambridge, Mass., September 1955.
19. R. M. Blount, G. Francis, R. W. Evans, *Study of Light Sources for Night Aerial Reconnaissance Photography*, Contract DA-36-039-SC-78333, Denver Research Institute, Denver, Colorado, August 1960.
20. George Shortley and Dudley Williams, *Elements of Physics*, 3rd Ed., Prentice-Hall, Inc., Englewood Cliffs, N. J., 1961.
21. S. Gladstone and B. Lewis, *Elements of Physical Chemistry*, Van Nostrand Co., Inc., Princeton, N. J., April 1960.
22. B. Douda, *The Theory of Colored Flame Production*, RDTN-71, Naval Ammunition Depot, Crane, Indiana; Bureau of Naval Weapons, Washington, D. C.
23. E. J. Bowen, *The Chemical Aspects of Light*, 2nd Ed., Clarendon Press, Oxford, 1946.
24. *International Encyclopedia of Chemical Science*, Van Nostrand Co., Inc., Princeton, N. J.
25. A. C. Gaydon, *The Spectroscopy of Flame*, Chapman and Hall, Ltd., London, 1957.
26. A. C. Gaydon and H. C. Wolfhard, *Flames, Their Structure, Radiation, and Temperature*, 2nd Ed., Chapman and Hall, Ltd., London, 1960.

## REFERENCES (cont'd)

27. Wallace R. Brode, *Chemical Spectroscopy*, John Wiley & Sons, N. Y., 1943.
28. A. Franson, S. Katz, and E. Raisen, "Radiation Characteristics of Black Body Sources," *Symposium on Temperature, Its Measurement and Control*, Reinhold Publishing Co., N. Y., 1962.
29. R. Kinglake, Ed., *Applied Optics and Optical Engineering*, Vol. I, Academic Press, 1965, p. 8.
30. J. Thewlis, Ed., *Encyclopedia Dictionary Physics*, Pergamon Press, Ltd., London, 1961.
31. M. G. Mellon, Ed., *Analytical Absorption Spectroscopy*, John Wiley & Sons, Inc., N. Y., 1950.
32. R. L. Weber, M. W. White, K. V. Manning, *Physics for Science and Engineering*, McGraw-Hill Book Co., Inc., N. Y., 1957.
33. R. C. Casperson, H. P. Lenzyck, R. C. Channel, *Visibility Data as It Applies to Pyrotechnics*, Contract DAI-28-017-501-ORD(P)-1294, Dunlap and Associates, Stamford, Connecticut, April 25, 1955.
34. E. Freeman, G. Weingarten, *A Thermal Theory for Rates of Propagative Burning*, Picatinny Arsenal Technical Report 2596, Picatinny Arsenal, Dover, N. J., June 1959.
35. D. Hart, H. J. Eppig, *Long Range Research on Pyrotechnics - Burning Characteristics of Binary Mixtures*, Picatinny Arsenal Technical Report 1669, Picatinny Arsenal, Dover, N. J., October 1947 (DDC-ATI 66 289).
36. Herbert Ellern, *Modern Pyrotechnics*, Chemical Publishing Co., N. Y., 1961.
37. B. E. Douda, *Relationships Observed in Colored Flares*, RDTR-45, Naval Ammunition Depot, Crane, Indiana; Bureau of Naval Weapons, Washington, D. C., September 1964.
38. R. F. Barrow and E. E. Caldin, "Some Spectroscopic Observations of Pyrotechnic Flames," *Proceedings of Physical Society of London*, 62 (1949).
39. B. E. Douda, *Emission Studies of Selected Pyrotechnic Flames*, RDTN-77, Naval Ammunition Depot, Crane, Indiana; Bureau of Naval Weapons, Washington, D. C., August 1964.
40. R. C. Folweiler, W. J. Mallio, *Thermal Radiation Characteristics of Transparent and Translucent Material Under Nonisothermal Conditions*, ASDTDR 62-719, Air Force Systems Command, Wright-Patterson Air Force Base, Ohio, June 1964.
41. B. Jackson, S. M. Kaye, G. Weingarten, *Resins Other Than Laminac 4116 as Binders in Pyrotechnic Compositions*, Picatinny Arsenal Technical Note 40, Picatinny Arsenal, Dover, N. J., January 1960.
42. H. J. Eppig, J. D. Stracham, *Self-Hardening Pyrotechnic Compositions*, Picatinny Arsenal Technical Report 1801, Picatinny Arsenal, Dover, N. J., December 1950.
43. D. Hart, *Research and Development in Military Pyrotechnics*, Picatinny Arsenal, Dover, N. J., February 1955 (DDC-TIP U10769).
44. B. Jackson, *An Investigation of the Effects of Loading Pressure, Flare Case Coating, and Magnesium Particle Size on the Burning Time, Luminous Intensity, and Color Characteristics of Pyrotechnic Flare Compositions*, Picatinny Arsenal Technical Note 14, Picatinny Arsenal, Dover, N. J.
45. R. M. Blount, R. W. Evans, *Experimental Investigation of Infrared Radiating Sources*, Denver Research Institute, Denver, Colorado, July 1961 (DDC-AD 324 807), March 1962 (DDC-AD 328 630), November 1962 (DDC-AD 332 848).
46. B. Jackson, *The Effect of Cross-Sectional Area and Case Material on Burning Characteristics of Pyrotechnic Compositions*, Picatinny Arsenal Technical Note 7, Picatinny Arsenal, Dover, N. J., September 1957.
47. A. F. Taschler, S. M. Kaye, *Effects of Magnesium Content Case Material and Case Coating on Burning Characteristics of a Flare System*, Picatinny Arsenal Technical Note 42, Picatinny Arsenal, Dover, N. J., April 1960.
48. S. Resnick, *Simulated High Altitude Tests of Illumination Compositions*, Picatinny Arsenal Report 2166, Picatinny Arsenal, Dover, N. J., April 1955.
49. W. A. Schmeling, *Applied Research for Threat Signature Generation Techniques*, Final Re-

## REFERENCES (cont'd)

- port, Denver Research Institute, Denver, Colorado, August 1963 (DDC-AD 340 411).
50. R. Shulman, *Effects of Variation of Cavity Geometry Upon Small Arms Tracer Burning*, Frankford Arsenal Report 1421, Frankford Arsenal, Philadelphia, Pa.
  51. E. S. Freeman, "The Kinetics of the Underwater Corrosion of Powdered Magnesium," *Journal of Physical Chemistry* 59, 1009 (1955).
  52. R. M. Blount, G. Francis, *Study of Light Sources for Night Aerial Reconnaissance Photography*, Contract DA-36-039-SC-78333, Denver Research Institute, Denver, Colorado, August 1960.
  53. J. R. Quick, R. T. Johnson, *Simplified Method of Determining Optimum Burst Altitudes for Aerial Photoflash Bombs Under Various Conditions of Light Output and Plight Altitude for Fixed Camera Trail-Angle Combination*, WCLR-55-5, Wright Air Development Center, Air Technical Service Command, Wright-Patterson Air Force Base, Ohio, November 1956 (DDC-AD 110 518).
  54. *Night Aerial Photography, A Technical History*, Wesleyan University, Middletown, Connecticut, July 1954 (DDC-AD 46 595).
  55. *The Magnesium Burner: Uses Other Than Photographic*, Wesleyan University, Middletown, Connecticut, May 1951 (DDC-ATI 168 202).
  56. *The Magnesium Burner, II. Fuels*, Wesleyan University, Middletown, Connecticut, October 1952 (DDC-ATI 171 350).
  57. R. T. Eckenrode and F. L. Marian, *The Spotting Technique: The Question of Spot vs Smoke and Spot Duration*, Memo for Record, Project TS 4-4020, Frankford Arsenal, Philadelphia, Pa., November 1964.
  58. R. T. Eckenrode, *The Spotting Technique: Effect of Ambient Illumination, Spot Intensity and Color, Memory Screen Information*, Memo for Record, Project 754, Frankford Arsenal, Philadelphia, Pa., October 1955.
  59. D. D. Collins, *Pyrotechnic Flashes and Flares in Guided Missile Tracking*, Redstone Arsenal, Huntsville, Alabama, December 1959.
  60. R. G. Weldon, *Development of the Signal, Plash, Guided Missile MK 37 Mod O for the Sparrow III Missile*, NAVORD 5860, Bureau of Naval Weapons, Washington, D. C., May 1958.
  61. J. W. Haldeman, *Development of the Signal, Flash, MK 49 Mod O for the Terrier BT-3 Missile and the Signal, Plash, MK 56 Mod O for the Corvus Missile*, NAVORD 7055, Bureau of Naval Weapons, Washington, D. C., September 1960.
  62. Air Force Manual 55-6, Department of Air Force, Washington, D. C.
  63. Air Force Manual 95-3, Department of Air Force, Washington, D. C.
  64. S. Haffner, *A Survey of Available Literature on the Rapid Combustion of Metals in Air*, Picatinny Report 2061, Picatinny Arsenal, Dover, N. J., September 1954 (DDC-AD 44 543).
  65. A. A. Shidlovsky, *Fundamentals of Pyrotechnic*, Government Publication of the Defense Industry, 1st Ed., Moscow, 1943 (Library of Congress Call No. UF 860.85), 2nd Ed., Moscow, 1954 (Library of the University of California, Berkeley, Calif.).
  66. S. Lopatin, *Sea Level and High Altitude Performance of Experimental Photoflash Compositions*, Picatinny Arsenal Technical Report 29, Picatinny Arsenal, Dover, N. J., October 1961.
  67. J. Hershkowitz, *The Action of an Explosive on Surrounding Nonreacting Metal Dust*, Picatinny Arsenal, Dover, N. J., December 1957 (DDC-AD-150 486).
  68. J. Hershkowitz, *The Mechanism of Ignition and Propagation of Oxidized-Metal Plashes*, Picatinny Arsenal, Dover, N. J., April 1958 (DDC-AD 156 424).
  69. R. M. Badger, A. L. Wahrhaftig, *Further Studies of the Effect of Composition on the Properties of Plash Powders*, Contract W-535-AC-24521, California Institute of Technology, Pasadena, California, July 1942.
  70. R. G. Clarke, W. C. Nelson, R. W. Stallbaum, *Photoflash Bomb. IV. The Effects of Cast and Hand Packed Bursters*, ORD 1951-2, Wes-

## REFERENCES (cont'd)

- leyan University, Middletown, Connecticut, June 1951 (DDC-AD 51 317).
71. *Further Investigation of Photoflash Powders*, Memo Report ENG-M-59-676-15-26, AAF Materiel Center, Photographic Laboratory Section, Air Technical Service Command, Wright-Patterson Air Force Base, Ohio, February 1943.
  72. P. Tavernier, *Contribution to the Study of Flash Powders*, Translation by U. S. Joint Publication Research Service of report from *Liberateire de la Commission des Substances Explosive*, 17 May 1944, Picatinny Arsenal Technical Memorandum 1072, Picatinny Arsenal, Dover, N. J., October 1963.
  73. G. Weingarten, *Chemistry of Pyrotechnics*, Presentation at Picatinny Arsenal, Dover, N. J.
  74. S. M. Kaye, J. Harris, *Effect of Puel and Oxidant Particle Size on the Performance Characteristics of 60/04 Potassium Perchlorate/Aluminum Flash Composition*, Feltman Research Laboratory Technical Report 44, Picatinny Arsenal, Dover, N. J., November 1961 (DDC-AD 266 486).
  75. S. Lopatin, C. A Knapp, *Pelletization of Illuminants to Improve Photoflash Efficiency*, Picatinny Arsenal Technical Note 24, Picatinny Arsenal, Dover, N. J., August 1959 (DDC-AD 207 077).
  76. R. G. Clarke, *The Photoflash Bomb. III. The Casing and the Dust Charge*, ORDWES Report ORD 1950-4, Wesleyan University, Middletown, Connecticut, June 1950.
  77. R. G. Clarke, C. B. Ford, *The Photoflash Bomb. II. Technical Developments in 1947-9*, ORDWES Report 1949-11, Wesleyan University, Middletown, Connecticut, May 1949.
  78. S. Lopatin, *High Altitude Plash Characteristics of Calcium/Potassium Perchlorate and Startdard Photoflash Compositions*, Picatinny Arsenal Technical Report 2646, Picatinny Arsenal, Dover, N. J., October 1959 (DDC-AD 313 204).

## CHAPTER 7

## PRODUCTION OF SMOKE

## 7-1 HISTORICAL SUMMARY, GENERAL

The military use of smoke for screening and/or signaling is probably as old as warfare itself.<sup>1,2</sup> Before gunpowder and other pyrotechnic mixtures were available, smoke was made by the burning of natural materials such as grass. The widespread, planned use of smoke in military operations may, however, be considered to be a development of World War I. During this period, smoke was used extensively for signaling, screening troop movements, and as a fear mechanism due to the resemblance of screening smokes to certain toxic chemical agents.<sup>1,3</sup>

The research and development concerned with the military use of particulate clouds started during World War I and was continued at a limited rate in the period between the two World Wars. The tactical significance of the planned use of smoke, which was not fully realized until the close of World War I, was strongly considered early in World War II where the requirements for smoke-producing devices were much greater. Consequently, extensive research and development programs were established early during World War II to obtain the information necessary to develop the tactically required smoke-producing items.

After World War II, research and development programs on particulate clouds of military interest were continued again at a reduced rate. In spite of this limited effort, information obtained from these programs proved valuable during the Korean Conflict. Since that time, work has progressed in the development of improved smokes and in fulfilling new requirements for aids in the tracking and acquisition of missiles and aircraft.

The research and development in exploiting the usefulness of particulate clouds for military purposes have also proved to be of great value for civilian applications. These include the physics of atomization, the production of high-efficiency

filters for industrial purposes, dispersion methods for chemicals used in the control of insects,<sup>3</sup> and cloud travel and contamination behavior for use in the solution of industrial pollution problems.

## 7-1.1 SCREENING SMOKES

The tactical possibilities of using smoke to screen friendly troops and terrain from enemy observation were comparatively late in being appreciated. Isolated tactical uses are recorded, such as the screening of a river crossing with the smoke produced by the burning of damp straw by Charles XII of Sweden in 1700.<sup>1</sup> However, for the century prior to World War I, the dense clouds of smoke incidental to the use of black powder had been a growing nuisance; and methods for the artificial generation of smoke for military purposes were neglected until just before World War I when the first experiments of this type were made in connection with naval operations.

The German Navy performed with ship-borne generators using sulfur trioxide and chlorosulfonic acid from 1906 to 1909 and used these methods for producing smoke in exercises carried out in 1914. At about the same time, the British and American Navies investigated the use of "funnel smoke" produced by restricting the air supply to the furnaces. The naval use of screening smoke developed rapidly enough so that the German Navy employed it with great success in the Battle of Jutland. Screening smokes played an increasingly important role in later naval engagements.

During World War I, the dense clouds produced in damp weather from chlorine gas also served to mask other activities and clearly demonstrated the tactical value of smoke in land warfare. The British, in 1915, were the first to make use of smoke on land to simulate gas attacks and to screen advancing troops. The material used to generate this smoke was the British type-S smoke

mixture of pitch, tallow, black powder, and saltpeter. The obscuring power of the smoke was due to incomplete combustion of the solid particles in the pitch. Screening smoke was used on a large scale by the Canadians in their attack on Messines Ridge in September 1915. During the following year, the use of smoke continued to increase as its value became apparent to all of the major belligerents.<sup>1</sup>

Both red and white phosphorus were soon introduced as smoke-producing materials. White phosphorus proved to be the more efficient of the two and was by far the most efficient smoke-producing material introduced during World War I. Sulfur trioxide was the next most efficient smoke-producing material used, in spite of the fact that humid air was required to form the sulfuric acid fumes. Other materials which produce sulfuric acid fumes on contact with humid air, such as oleum, chlorosulfonic acid, and sulfuryl chloride, were also widely used. The two latter materials also produced hydrochloric acid fumes. Metallic chlorides, including tin tetrachloride (British K.J., French Opacite), titanium tetrachloride (German F-Stoff; United States FM), and silicon tetrachloride, were also used.

Another group of materials, producing the so-called zinc smokes, were basically mixtures of zinc dust and an organic chlorine-containing compound. The Berger mixture, used by the French during World War I, was composed of zinc dust, carbon tetrachloride, zinc oxide, and kieselguhr. An improved mixture was developed in 1917 by the U. S. Bureau of Mines and was known as the BM Mixture. This mixture consisted of zinc dust, carbon tetrachloride, sodium chloride, ammonium chloride, and magnesium carbonate.

The introduction of military aircraft, especially bombers which could attack important rear-area targets, created a definite need for large-area smoke screens for protection. Consequently, much of the effort between the two World Wars was directed toward developing techniques for producing these large-area smoke screens, including the use of aircraft for this purpose.<sup>4,5</sup> At the beginning of World War II, however, neither the United States nor Great Britain had a satisfactory mate-

rial or a suitable method for producing large-area screens.

The smoke munitions available in 1940 included projectiles, bombs, smoke pots, grenades, and airplane spray tanks, which were sufficient to enable ground tactical units to conceal their movements by laying curtains of smoke across the battlefield. The tactical employment of small, smoke-producing munitions was established as a result of actual experience in field maneuvers and demonstrations. The principal screening materials available included sulfur trioxide-chlorosulfonic acid (FS), a liquid solution for use in projectiles and airplane spray tanks; hexachloroethane-metallic zinc mixture (HC), a solid mixture used in burning-type munitions such as grenades and smoke pots; and white phosphorus (WP), used in grenades, projectiles and bombs. These materials were superior to similar materials developed and used during World War I.

The effectiveness of German air operations against British cities during 1940-41 was considerably reduced through the use of large-area smoke screens which prevented accurate aiming. The British protected important industrial centers with smoke pots of an oil-burning type similar to the smudge pots used in United States orange groves. Lines of smoke pots were laid out in such a manner that the vital area was screened under any wind direction. The operation of this type of stationary smoke pot line required an extensive supply system since all important areas needed protection. As a result, the British developed truck-mounted mobile generators, the most suitable of which was known as the "Haslar" which produced a gray-brown smoke by burning and vaporizing crude oil.<sup>4,5</sup>

In the United States, the Defense Department and the National Defense Research Committee, along with several universities and industrial concerns, cooperatively embarked on a research program to produce large-area smoke screens. Early in 1942, the optimum particle size for a hydrocarbon smoke was determined and mechanical smoke generators were developed to produce this type of screen.<sup>6</sup> Work on smoke pots based on the venturi principle was started at this time using fuel blocks to vaporize volatile materials; however,

these devices were not fully ready for production during World War II.

The smoke-producing materials such as WP, FS, and HC had disadvantages which at times, limited their usefulness in World War II. All of the smokes produced from these materials were irritating. FS smoke was corrosive in the presence of moisture. WP smoke tended to rise rapidly, or to pillar, due to the heat given off by the burning phosphorus. HC, and similar smoke compositions, produced zinc chloride which was toxic. In spite of the disadvantages, these items were used, along with the newly developed, mechanical smoke-producing devices, in advancing the strategic and tactical use of smoke during World War II. For the first time, large areas, including whole cities, could be screened from aerial observation for relatively long periods of time.<sup>4,5</sup>

Screening smoke again proved to be of value in the Korean action in which the United Nations' Forces operated without the benefit of air superiority for much of the time. Hence, large-area screens were employed to protect vital port areas as well as forward combat areas.<sup>7</sup> In addition, much of the Korean action was a struggle for dominating terrain, and smoke was constantly used in relatively small-scale operations. Colored smoke was also used for screening personnel withdrawal operations because it persisted longer than the white phosphorus smoke normally used for this purpose.<sup>1,6,8</sup>

### 7-1.2 SIGNAL SMOKES

The need for methods of signaling when neither hand signal nor flag is visible, nor the sound of voice or horn is audible, has long been recognized. Smoke signals have been used for this purpose since ancient times. However, the thick haze of black powder smoke which enveloped battlefields virtually eliminated smoke as a signaling agent for a time. The introduction of smokeless powder again made smoke signals a valuable method of communication in military operations. In spite of the many improvements in communications methods, signal smoke continues to have an important place in modern warfare.

Prior to World War I, a limited number of pyrotechnic items, mainly colored flares, were used

by the Services. Little information on the manufacture and application of colored smoke signals was available in the United States at the beginning of World War I due, mainly, to the curtailment in fireworks manufacture. Investigations were started by various civilian and military agencies. Various types of smoke signals—including both parachute and nonparachute rockets, rifle grenades, Very pistol cartridges, hand grenade signals for aviators, submarine recognition signals, and smoke pots for ground use—were developed in a variety of colors. Inasmuch as the American Expeditionary Forces were to operate in a sector held by the French Army, it was found expedient to adopt the entire French Army system of pyrotechnics.

The French used colored smoke signals which consisted of red and yellow smokes in signal parachute rockets, rifle grenades, 25 mm and 35 mm Very pistol cartridges, and a messenger signal. The only French smoke manufactured in the United States was yellow smoke, since this item could be produced from available ingredients; the other colored smokes, such as red, could not be manufactured because necessary dyestuffs were in short supply at that time. The United States did not develop mortar or artillery projectiles producing colored smoke during World War I.

The British Army also recognized the need for colored smoke signals and developed a number of such munitions early in World War I. Red, yellow, blue, and violet smokes were developed for use in rifle grenades (with or without parachutes), in Very pistol cartridges, and in 3-inch mortar projectiles. A red and blue smoke filling for the 4.5-inch projectile was developed for artillery spotting and aviation signaling. Dummy drop bombs or subcaliber bombs containing colored smoke fillings were developed for training purposes. By the close of World War I, the Allies succeeded in developing experimental colored smoke rifle grenades as well as rockets and Very cartridges in a variety of colors. They also made some use of colored smoke for artillery spotting. Virtually no information is available concerning the use of colored smoke by the Germans and Italians during World War I.

Although the research and development effort in the United States proceeded at a reduced rate

in the period between World Wars I and II, a considerable number of munitions for producing colored smoke were developed. Included among these items were colored smoke hand and rifle grenades, canisters containing colored smoke fillings for various calibers of projectiles, colored streamer smoke bombs, colored smoke markers for aerial delivery containers, and colored bursts for the 4.2-inch chemical mortar projectile. All of these were produced in a variety of colors. The British Army also developed colored smoke rifle and hand grenades, and colored smoke fillings for most of their artillery projectiles. The German Army limited their colored smoke signals to various small hand signals.

Extensive use of signal smoke in World War II and the Korean Conflict proved that the use of colored smoke for signaling purposes has an important place in the communications system of modern warfare. Four colors—red, green, yellow, and violet—were found to be the most suitable. Smokes were also of value in marking a specific operations area or target. They also played an important part in antisubmarine warfare and in air-sea rescue operations. In many instances, especially in the Korean Conflict, the use of pyrotechnic signals, including smoke, was much faster and more effective than more modern communications methods when the tactical situation was degenerating.<sup>9</sup>

### 7-1.3 TRACKING AND ACQUISITION SMOKES

Smoke has been found to definitely complement the observance of tracer projectiles and, more recently, has been used as a space vehicle tracking aid. Tracer bullets, while developed as a light-producing device for improved aim and fire control for automatic weapons, emit distinct amounts of white smoke which is composed essentially of metal oxide particles. Under certain atmospheric conditions, such as firing into bright sunlight, the smoke trail is easier for a gunner to follow than a red flame tracer, although the flame tracer is the best under most other conditions. In 1923, studies were undertaken to develop a smoke tracer. It was soon apparent that attempts to increase the volume of the smoke trail along the trajectory re-

sulted in a decrease in the flame color and intensity. Since the flame tracer was considered most important, the work was not pursued. After World War II, a requirement for smoke tracers was re-established, and improved smoke tracers were developed based on the use of organic dyes,<sup>10</sup> the best of which were of the anthraquinone series producing orange-red smoke. These smoke tracers were developed primarily for training pilots to improve their gunnery score with wing-mounted guns. Due to the pilot's extreme forward position in the aircraft, flame tracers coming from the wing guns in the rear were difficult to pick up and follow visually as they passed. Smoke tracers, on the other hand, left a lingering trail which was easier to sight and point at the target. However, since they could not be seen readily at night they were not considered all-purpose tracers and, consequently, did not become standardized.

In 1950, development of spotting bullets as an additional aid for fire control and target acquisition was undertaken.<sup>11</sup> A smaller caliber spotting bullet was designed to match the trajectory of the major round at the critical range. Upon impact with the target or nearby, the spotting bullet exploded to give flash and smoke. Since the flash was of extremely short duration (30 to 50 milliseconds), the smoke puff became of greater importance because it rose and lingered over the point of impact for a longer period so that the gunner could readily correct his aim. This development resulted in the standardization of the caliber .50 M48 combination spotter-tracer round and the development of a new family of spotting rounds.

Another use for the smoke-producing devices resulted from the increasing speed of air or space vehicles which were developed after World War II. In order to assist test personnel in the optical tracking of these vehicles, it was necessary to develop smoke-producing tracking aids, some of which were required to function at extremely high altitudes.

### 7-2 PROPERTIES OF SMOKE

The value of a military smoke, whatever its use, is related to the scattering, reflection, and absorption of incident radiation by small suspended particles. These properties are associated with the



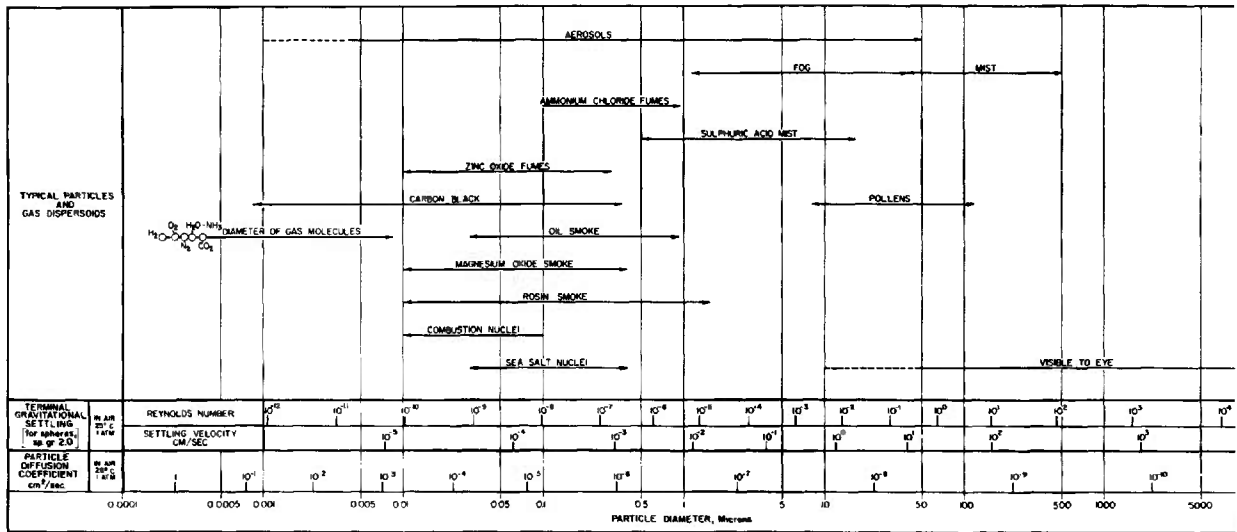

Figure 7-7. Approximate Size Range of Airborne Particles

number, size, and nature of the suspended particles. The number of particles, their size and initial behavior depend upon the smoke agent, the particular munition, and the method of release. The density, persistency, and subsequent behavior of the smoke cloud also depend on meteorological conditions, such as humidity, wind speed, wind direction, and air stability.

**7-2.1 PROPERTIES OF PARTICULATE CLOUDS<sup>8,12</sup>**

The classification of types of suspensions in terms of their nature, origin, and particle size has not been completely successful due to their indefinite characteristics and because of the differences, not always clear-cut, between descriptive terms in scientific and common usage. A gaseous suspension of liquid or solid particles the diameter of which is less than 100 microns is commonly called a particulate cloud. There are three broad classes of particulate clouds: (1) dusts, (2) mists, and (3) smokes. If the particles in any particulate cloud are less than approximately 10 microns in diameter, they are called aerosols. The term aerosol was introduced to cover only fine, aerial suspensions. It has, however, been applied in recent years to almost any aerial suspension of particles. In some cases, especially in the United States, the term aerosol is used instead of particulate cloud.

Dusts are particulate clouds made up of solid particles formed by the mechanical disintegration of matter. The diameter of the particles in a dust range from about 0.1 micron to greater than 100 microns.

Mists are gaseous suspensions of liquid droplets produced by the condensation of a vapor or atomization of a liquid. Mists, especially those occurring naturally, consist of relatively large particles ranging in size from around 5 microns to larger than 10 microns. If the concentration of droplets is great enough to interfere with vision, it is called a fog.

A smoke is a suspension in a gaseous medium, such as the atmosphere, of small particles which have a relatively low vapor pressure and which settle slowly under the influence of gravity. Although smokes are often characterized by their mode of formation, the main criterion is one of particle size. While, at one time, only clouds formed by combustion and destructive distillation were classified as smokes, at present any gaseous suspension of particles ranging in size from approximately 0.01 to perhaps 5.0 microns in diameter, and which cannot be classified as a dust or mist, is considered to be a smoke. In many cases the smoke particles are aggregates of many extremely small, primary particles. Carbon smokes, for example, are composed of extremely small,

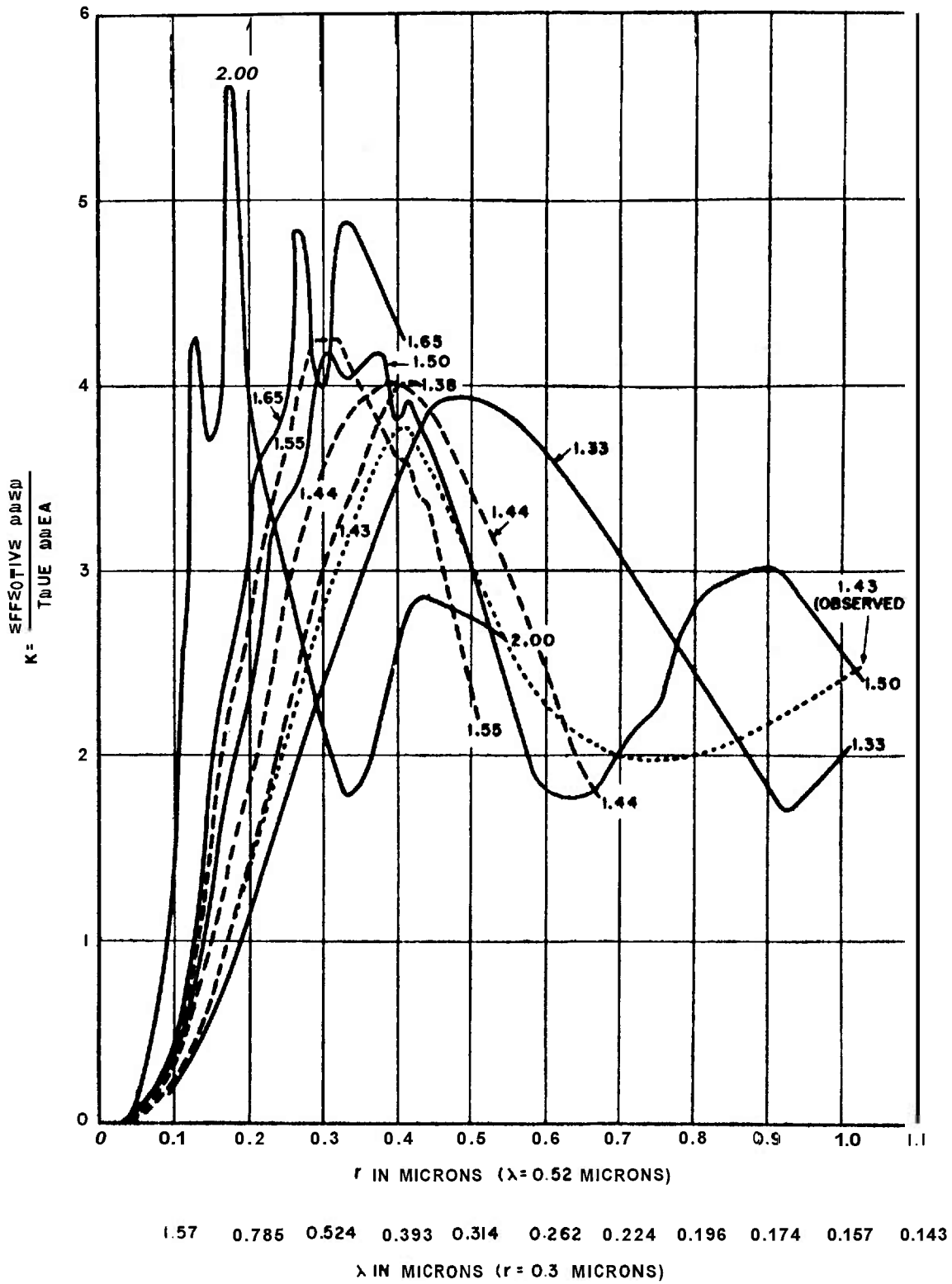

Figure 7-2. Scattering by Spherical Particles With Indicated Refractive Indexes

primary particles of approximately 0.02 micron in diameter which coagulate into irregular filaments that may reach a length of several microns. In Figure 7-1 is shown the approximate particle size ranges for typical airborne particles.

### 7-2.1.1 Optical Properties of Particulate Clouds

Particles suspended in a gaseous medium scatter, reflect, and absorb radiation in a manner which depends on the nature, size, and shape of the particle, and the wavelength of the incident radiation. These factors, in turn, determine the effectiveness of a smoke for screening and its visibility when used for signaling or similar purposes.

The scattering of light by a particle can be treated as the interaction between the electromagnetic waves and the particle. When light strikes a particle which is comparable in size to, or smaller than, its wavelength; reflection and refraction, in their normal sense, no longer occur. Interaction between the radiation and particle results in energy being removed from the wave front. Some of this energy is degraded to heat but much is re-radiated as scattered radiation. Each particle becomes, in effect, a self-luminous source.

The theory of scattering by spherical particles was developed from Maxwell's equations by Gustave Mie.<sup>13</sup> For spherical particles which are small compared to the wavelength of light, this theory gives results which are in complete agreement with the results obtained from the less-general Rayleigh theory which states that the amount of radiation scattered is inversely proportional to the fourth power of the wavelength. As the particle radius increases in size to approximately the wavelength of the light, the scattering becomes a complex function of the particle radius, the refractive index of the particle, and the wavelength of the incident light. The scattering coefficient, i.e., the scattering index, is an extremely complex function of the parameter  $r/\lambda$ , where  $r$  is the radius of the particle and  $\lambda$  is the wavelength of the incident light, and exhibits one or more peaks before approaching the limiting value of 2.0 as is shown in Figure 7-2. As the refractive index of the particle increases, the peak in these curves moves toward smaller radii particles. For screening smoke made from fog oil which has a refractive index of 1.50, the maximum

scattering of vehicle light will occur when the droplets are about 0.3 micron in diameter.

The angular distribution of the scattered light is also a function of  $r/\lambda$ . For Rayleigh scattering by small particles, the forward and backward scattering is the same. With an increase in the particle radius, the forward scattering becomes much greater. For a particle whose radius is equal to or greater than the wavelength of light, this factor may be 1000 or more in favor of the forward scattering.

Smoke clouds, which have a distribution of particle sizes, exhibit the scattering which would be observed for a mixture of a large number of different uniformly sized smokes mixed in varying proportions. No completely satisfactory analysis of the amount of scattering that may be expected from such a polydispersed smoke cloud has been made.

The theoretical treatment of the scattering of light by particles which also absorb is a difficult problem, especially when absorption is selective. When the incident light is white, the scattering by each of the particles will remove some of the light selectively absorbed so that the light finally scattered by the cloud will be colored.

### 7-2.1.2 Properties of Particulate Clouds Affecting Their Stability

Smoke clouds and other particulate clouds are essentially unstable and will eventually disappear with time due to: (a) motion of the particles, (b) evaporation and/or condensation, and (c) coagulation and agglomeration.

#### 7-2.1.2.1 Motion of Smoke Particles

Movement of smoke particles under the influence of gravity and as a result of random bombardment by gas molecules (Brownian motion) may cause particles to disappear by sedimentation or diffusion. Sedimentation effects are important for particles one micron and larger, while diffusion effects are important only for much smaller particles.

##### 7-2.1.2.1.1 Sedimentation

An individual particle settling under the influence of gravity will reach a terminal velocity

when the aerodynamic drag on the particle is equal to the effective weight of the particle. If the particle is a rigid sphere which is large with respect to the mean free path of the gas, but not so large that inertia effects are important, Stokes' Law is applicable, and the terminal velocity  $v$  is given by :

$$v = \frac{gd^2(\rho - \rho')}{18\eta} \tag{7-1}$$

where  $d$  is the diameter of the particle,  $\rho$  is the density of the dispersed phase,  $\rho'$  is the density of the gas,  $\eta$  is the viscosity of the gas, and  $g$  is the acceleration due to gravity. Particles which are small with respect to the mean free path of the gas fall somewhat more rapidly than this equation indicates, while large particles settle somewhat more slowly.

The rate of sedimentation for some particles is given in Table 7-1. It is to be noted that the sedi-

**TABLE 7-1**  
**TERMINAL VELOCITIES AND DIFFUSION**  
**COEFFICIENTS OF RIGID SPHERES OF**  
**UNIT DENSITY IN AIR AT 760 mm Hg**  
**PRESSURE AND 20°C**

<i>Diameter,</i> <i>microns</i>	<i>Velocity,</i> <i>cm/sec</i>	<i>Diffusion Coefficient,</i> <i>cm<sup>2</sup>/sec</i>
0.1	$8.71 \times 10^{-5}$	$6.84 \times 10^{-6}$
0.2	$2.27 \times 10^{-4}$	$2.02 \times 10^{-6}$
0.4	$6.85 \times 10^{-4}$	$8.42 \times 10^{-7}$
1.0	$3.49 \times 10^{-3}$	$2.76 \times 10^{-7}$
2	$1.19 \times 10^{-2}$	$1.28 \times 10^{-7}$
4	$5.00 \times 10^{-2}$	$6.16 \times 10^{-8}$
10	$3.06 \times 10^{-1}$	$2.41 \times 10^{-8}$
20	1.2	----
40	5	----
100	25	----

mentation rate of a screening smoke which has a particle radius of 0.3 micron is about one mile per year.

Nonspherical particles generally attain a lower terminal velocity; however, this effect is not completely predictable. If the smoke is heterogeneous, the particles will settle at different rates causing

collisions between particles and resulting in coagulation or agglomeration of the particles.

**7-2.1.2.1.2 Diffusion**

Diffusion of particles due to Brownian motion results because the particles are impacted by the gas molecules of the suspension medium. The motion imparted to the smaller particles is greater than that imparted to the larger particles so that the amount of diffusion is inversely proportional to the diameter of the particles.<sup>3</sup> Diffusion effects are relatively unimportant for most particulate clouds of military interest.

**7-2.1.2.2. Evaporation and Condensation**

The evaporation rate for a given material depends on the difference between the vapor pressure of the dispersed material and the actual partial pressure of its vapor present in the air. At a given temperature, the vapor pressure of a liquid increases with the degree of curvature of its surface; this increase becomes marked as the droplet size decreases. Hence, a critical droplet exists for any temperature and vapor concentration. Droplets smaller than the critical size will evaporate because their vapor pressure is higher than the partial pressure in the vapor phase, while those larger than the critical size will grow as a result of condensation. The same considerations apply to the sublimation pressure of a small, solid particle.

**7-2.1.2.3 Coagulation and Agglomeration**

The process of continuous and spontaneous formation of larger particles is one of the striking characteristics of any particulate cloud and can be a major factor in the diminution of a smoke cloud; liquid particles coalesce while solid particles agglomerate when they collide. As this process continues, the smoke becomes coarser and finally settles out. It has been found experimentally that the rate of decrease of the number of particles,  $-\left(\frac{dn}{dt}\right)$ , is proportional to the square of the concentration  $n$ , or:

$$-\left(\frac{dn}{dt}\right) = Cn^2 \tag{7-2}$$

where  $C$  is the coagulation constant. In integrated form :

$$\left(\frac{1}{n}\right) - \left(\frac{1}{n_0}\right) = Ct \quad (7-3)$$

where  $n_0$  is the number of particles at  $t = 0$ .

While it is difficult to calculate the exact degree of polydispersity, it can be shown that the probability of collision between particles of unequal size is greater than that between particles of equal size. Hence, polydisperse smokes coagulate faster than those which are monodisperse. Moreover, differential settling also increases the probability of collisions between particles of different sizes. The coagulation rate of smoke is increased by stirring, since eddies and swirls result in particles having a higher relative velocity which increase chances of collisions resulting in an increased coagulation rate.

## 7-2.2 TRAVEL AND PERSISTENCE OF PARTICULATE CLOUDS<sup>8,12</sup>

The behavior of a particulate cloud is strongly influenced by the diffusive properties of the atmosphere. For example, the persistence of screening smokes, which are composed of particles too small to fall out appreciably by Stokes' Law and which have too low a vapor pressure to evaporate, is almost completely dependent on meteorological factors which tend to dilute the cloud. The form of a particulate cloud in the atmosphere depends upon the location, type, and configuration of its source. When a cloud is emitted from a jet at a considerable velocity, mechanical turbulence and rapid mixing with the air results. This initial condition of turbulence disappears by the time the cloud has traveled a short distance from the generator. Also, the formation of particulate clouds of military interest is accompanied by sufficient heat so that the cloud as a whole will rise. As the cloud becomes more and more diluted with cooler air this effect will be less observable unless there is a very great initial rise in temperature, as is the case when smoke is produced by the burning of white phosphorus. (See Paragraph 7-3.3.2.1.)

The process by which smoke is diluted and mixed with air is called "atmospheric diffusion." This process is also termed "eddy diffusion" to distinguish it from molecular diffusion since eddy-Eke

motions of from one to many feet in diameter are observed. The amount of atmospheric diffusion is indicated by the angle of rise and angle of spread of the cloud as it travels downwind from the source. The initial angles of rise and spread usually will be different than those measured farther away from the point of generation.

### 7-2.2.1 Meteorological Factors

While the initial behavior of a particulate cloud normally is due to the transient effect of the heat and turbulence resulting from the process by which the particulate cloud is generated, the behavior of the cloud at a distance from the generator depends on the meteorological conditions prevailing. The principal meteorological factors affecting travel of this type of cloud are wind speed, direction, turbulence in the lower atmosphere, and thermal gradients.

#### 7-2.2.1.1 Wind Speed and Direction

To obtain a cloud concentration in an area from a limited number of stationary sources, a wind velocity of fixed speed and direction is desirable. Too high a wind speed requires an exorbitant rate of production in order to maintain proper coverage, while too low a wind speed requires excessive time to develop the cloud. If there is no wind, good results can only be obtained by producing the cloud from a moving vehicle such as a plane or boat, or by the projection of smoke generating munitions into the area. The latter method is feasible only in offensive operations. Conditions of very low wind speed are likely to be accompanied by sudden variations in the wind, carrying the particulate cloud into areas where it is not desired.

When a particulate cloud is emitted by a stationary generator in a steady wind, the plume travels downwind with the speed of the wind and the axis of the plume is parallel to the wind direction. The density of the cloud at any point downwind will be, in general, approximately inversely proportional to the wind speed.

#### 7-2.2.1.2 Turbulence

Wind speed and direction are subject to rapid and violent fluctuation. This unsteadiness in wind

velocity and direction can be considered to be due to pulsations taking place in three directions; namely, in the general direction of the wind, and in horizontal and vertical directions at right angles thereto. The total of these pulsations in the different directions is a measure of the gustiness or turbulence of the atmosphere.

One obvious cause of turbulence is mechanical. The higher the wind velocity, the greater the turbulence, particularly over rough terrain. Over a smooth surface of water there will be no turbulence produced by mechanical causes at low wind speeds. Wind speeds greater than 10 to 11 knots, however, will produce waves which, in turn, produce mechanical turbulence in the lower air layers.

Another important factor in producing turbulence is thermal instability in the lower atmosphere. During the day in bright sunshine, the ground surface receives a great deal of heat from the sun and, since the earth is a poor conductor, the temperature of the surface will rise many degrees. The layer of air in contact with the ground is heated and, since it becomes lighter by expansion, the layer rises. Since the warm lower layer of air cannot rise everywhere uniformly, it must break through the upper cooler layers somewhat as bubbles burst upward through a liquid. The actual driving force is the weight of the cooler air, which settles toward the ground displacing the warmer, lighter air. These upward, convective currents cause the bumpiness of the air which is noticeable in an airplane. The passage of a warm or cold front may completely alter the temperature relation between the ground surface and air and produce stability or instability regardless of time of day or sky conditions.

#### 7-2.2.1.3 Thermal Gradient

Stability conditions in the atmosphere are determined by the temperature gradient therein. If the temperature decrease with height is more than 1°C per 100 meters, the air will be unstable; i.e., the lower layer of air will tend to rise and continue to rise as long as this condition prevails. This is caused by the rising mass of air, expanding and cooling as it rises, becoming warmer and lighter than the surrounding air. If the decrease in temperature with altitude is between zero and 1°C

per 100 meters, there will be no tendency for the air to rise because the air mass carried upward will become colder and heavier than the surrounding air. This decrease of temperature with altitude of 1°C per 100 meters is termed by the meteorologist the adiabatic lapse rate for dry air, and the degree of stability or instability of the atmosphere will depend upon the extent to which the temperature gradient departs in one direction or the other from this critical value. An extreme condition, when the temperature increases with altitude, is known as inversion, which causes extreme stability in the lower atmosphere. The meteorological factors described contribute to the degree of stability of the atmosphere which exerts a considerable influence on the performance of a smoke cloud. Extreme conditions of stability or instability will influence the effectiveness of the smoke cloud in a particular tactical situation.

### 7-2.2.2 Stability of Aerosol Clouds Under Various Meteorological Conditions

#### 7-2.2.2.1 Stable Conditions

Under inversion conditions over smooth terrain such as calm water, the only tendency shown by a smoke cloud to rise and spread is due to the initial transient effect caused by the heat and turbulence produced by the smoke generator. The turbulence is quickly damped out but the heat produced may be sufficient to cause a very pronounced rise, as is the case with white phosphorus smoke munitions. In the case of oil smoke, where the amount of heat produced is small, the temperature of the smoke at any dilution is only slightly greater than the temperature required to produce a buoyancy sufficient to offset the increase in density caused by the presence of the smoke material. As the smoke rises, the temperature falls because of two effects; namely, further dilution with cool air, and adiabatic expansion due to a decrease in barometric pressure. Since, in an inversion, the temperature of the surrounding air increases with increasing altitude, an elevation is soon reached at which the smoke is stable, possessing a density identical with that of the surrounding air.

Oil vapor smoke is often observed to level off

at an elevation of approximately 100 feet under stable air conditions. Certain types of smoke exhibit an erratic behavior because of abnormal density. Examples of these are: (a) the smoke produced by burning oil in an orchard heater in which carbon particles and carbon dioxide gas are present, and (b) HC smoke in which large particles of zinc chloride and other heavy materials are formed. While a substantial amount of heat is produced in the formation of these smokes, much of it is quickly lost by radiation, particularly at night. Since the heat produced in the generation of the smoke will usually cause the smoke cloud to rise even under the most stable conditions, it may be anticipated that the cloud will lift entirely off the ground after a short distance of travel. If, however, a wind of considerable velocity is blowing, this lifting from the ground will not occur.

Although the heat produced in the smoke generator promotes a rise, it has little effect upon the spread of the smoke cloud. The spread that occurs is due to initial turbulence and this soon damps out. Consequently, if it is desired to produce continuous clouds of smoke from a series of individual generators, it is necessary to place the generators very close together; otherwise, the individual plumes may not merge for a long way downwind. This situation holds for smooth terrain. However, if the terrain is covered with shrubbery, for example, the lateral spread of the cloud is greatly increased as a result of the mechanical turbulence produced by the wind flowing through the shrubbery.

#### 7-2.2.2.2 Unstable Conditions

When the air current is turbulent because of thermal instability, atmospheric diffusion takes place to such an extent that the initial, transient behavior of the cloud, due to the heat and turbulence from the generator, is of little significance. The aerosol cloud continues to rise and spread as it travels downwind until the cloud becomes so thin that its boundaries are no longer distinguishable to the eye. If a time exposure were to be taken of the cloud, it would appear as a cone with its apex at the generator and its axis rising at an angle from the horizontal, the angle of rise depending upon the degree of instability and the

wind velocity. An instantaneous view of the cloud would show that it is furrowed and broken by variations in the wind direction and sudden upward convective currents.

The lower air is thermally unstable when the negative temperature decrease with altitude is more than 1°C per 100 meters of elevation near ground level. This negative gradient may continue indefinitely upward. Thus, in thunderstorms, cumulus clouds often rise to a height of several miles; a smoke cloud would be carried to the same height.

Under other circumstances, a current of warmer air may be blowing at an elevation of a few hundred feet so that the temperature gradient may become zero, or even positive, giving an inversion at this elevation. There is no tendency for the lower air to rise through this warmer lighter layer, and a definite ceiling will be established for the convective turbulence. Within this layer the atmosphere turns over and over, and the smoke may become diffused throughout the layer before it has traveled very far. However, eddy diffusion always occurs at the boundaries of the upward convective currents, causing some smoke to diffuse throughout the settling layer of cooler air even with a high convective ceiling.

The rate of rise of the convective current increases with thermal instability. The angle of rise of the smoke cloud (as a statistical average) is inversely proportional to the wind velocity. With zero wind, the convective currents rise directly upward. As the wind increases, the direction of the convective current is inclined increasingly away from the vertical.

#### 7-2.2.2.3 Estimation of Atmospheric Diffusion<sup>3</sup>

Two expressions were derived which enable the concentration  $x$  (grams per cubic centimeter) at a given point in a smoke cloud to be predicted from knowledge of the rate of emission of particulate matter and of certain meteorological properties of the atmosphere. These equations for predicting the concentration from continuous point and line sources at ground level are:

Continuous point source emitting  $Q$  grams per second:

$$x_p(x,y,z) = \frac{2Q}{\pi C_y C_z \bar{U} x^{2-n}} \exp \left[ -x^{n-2} \left( \frac{y^2}{C_y^2} + \frac{z^2}{C_z^2} \right) \right] \quad (7-4)$$

Continuous crosswind infinite line source emitting  $Q$  grams per second per centimeter :

$$x_L(x,z) = \frac{2Q}{\pi^{1/2} C_z \bar{U} x^{1-2n}} \exp \left[ \frac{-z^2}{C_z^2 x^{2-n}} \right] \quad (7-5)$$

where the space coordinates  $x$ ,  $y$  and  $z$  (**origin** at the source) refer to the downwind, crosswind, and vertical directions, respectively;  $\bar{U}$  is the mean wind velocity;  $C_y$  and  $C_z$  are generalized eddy diffusion coefficients; and  $n$  is a parameter referring to the stability of the atmosphere, the numerical value of which varies between zero and unity. These equations indicate that the concentration varies directly with the source strength  $Q$  and approximately inversely with the mean wind velocity  $\bar{U}$ . The distribution of concentration in the crosswind direction and in the vertical direction is approximately Gaussian; however, due to ground reflection, the vertical distribution corresponds to only one-half of the Gaussian curve. If the terrain is level and there is only a small temperature gradient,  $n$  is approximately 0.25. Under these conditions, the peak concentration downwind from a point source will decrease as  $x^{-1.75}$ , and for a line source as  $x^{-0.88}$ .

### 7-2.3 SPECIFIC PROPERTIES OF MILITARY SMOKES

Smokes are used for four basic military purposes: (1) for screening, (2) for signaling, (3) for tracking and acquisition, and (4) for disseminating (see Paragraph 7-3) of agents in riot control and other applications. While smoke may be produced from a large number of chemicals in a variety of ways, only a few of these meet the specific requirements for a military smoke. The ideal military smoke material will:

- Be available in sufficient quantities for large-scale production of the mixture at a relatively low cost.
- Be easily and efficiently disseminated without the use of elaborate equipment.

- Be persistent when disseminated, i.e., it will not evaporate, fall out or coagulate rapidly.
- Be effective at a low concentration of material.
- Be substantially nontoxic; noncorrosive to equipment, and, except for control agents, nonirritating to the eyes, throat and skin.
- Be suitable for large-scale manufacture, storage, and transportation, without hazard or deterioration.

#### 7-2.3.1 Screening Smokes

Screening smokes are usually white and can be used to:

- Conceal movements, intentions, equipment, and installations of friendly forces from ground observation.
- Blanket friendly positions and installations in order to conceal them from air observation and attack.
- Prevent aimed fire on approaching friendly aircraft, i.e., to screen the landing of airborne troops by parachute and glider.
- Provide an extensive, thin haze for concealment of friendly areas without seriously impeding close-range vision.
- Establish dummy screens to deceive observers.
- Communicate.
- Form a thermal radiation attenuation screen.

There are three types of smoke screens. A smoke screen laid over friendly areas to hinder enemy aerial observation and visual precision bombing is called a **blanket screen**. This type screen is formed by the gradual merging, downwind from the source of generation, of individual smoke streams. A **smoke haze** is normally established in a battle area to conceal friendly activities from observation and ground fire. It is formed in much the same manner as a blanket screen. Usually, however, a smoke haze is less uniformly dense than a smoke blanket. A **smoke curtain** is a dense, vertical development to conceal objects at ground level from observers at ground level.

Under many circumstances these distinctions disappear. For example, a **smoke curtain** may in-



terfere with aerial observation or a blanket screen may settle to the ground and become a smoke curtain. These distinctions are important for defensive screening only, inasmuch as offensive use of smoke has the primary objective of blinding unfriendly forces by enveloping them in a dense blanket of smoke at ground level. Due to the required subsistence of smoke screens, large quantities of near optimum materials must be used. Of the large number of available smoke-producing chemicals, only a few have been found suitable for use in the production of military smoke screens.

### 7-2.3.2 Signal Smokes

It is a prerequisite that smokes used for signaling and communications be clearly distinguishable from other smokes (and other clouds) produced for different purposes. Thus, the use of white, gray, and blanket smokes for signaling is very limited and colored smokes are normally used for this purpose. In addition, the use of several different colors allows more information to be transmitted and also results in a clearer distinction between the smoke signals and a varying background. Effective methods for the production of colored smoke, including explosive dissemination, involve the vaporization and condensation of a dye; therefore, the dye must be heat-stable so that it can be rapidly vaporized at a relatively high temperature without appreciable thermal degradation. In addition to its color, important characteristics of a colored smoke include :

- a. Visibility (the conditions under which the cloud can be seen and its color recognized).
- b. Duration (the time period during which smoke is evolved from a munition).
- c. Persistence (the total period of time during which a cloud is visible).
- d. Volume (the quantity of smoke emitted; for colored smokes, volume has also been defined as the cross-sectional area of a cloud presented to an observer).

Although not as important as in the case of screening smoke, the smoke cloud should be as nontoxic, nonirritating, and noncorrosive as possible. Information on the composition, method of

dissemination, measurement, etc., of colored smokes is contained in Paragraph 7-3.4.

### 7-2.3.3 Tracking and Acquisition Smokes

Smoke-producing devices such as generators or tracers are used as an aid in the optical tracking of projectiles, high speed aircraft, and missiles both at sea level and high altitudes. These devices optimize the ability to locate and track vehicles along the flight path and minimize the possibility of losing significant data. Requirements for optical tracking aids vary considerably because of the wide range of conditions encountered in the tracking of test vehicles operating over a wide range of altitudes and speeds. No single smoke agent or generating system will satisfy all requirements and numerous smoke-producing methods are necessary. Each is designed for a particular application, emphasizing certain ideal characteristics.

While the value of a screening smoke is due to its absorbing and light-scattering power, the visibility of a smoke tracking aid is due, chiefly, to its light-scattering power. The ideal tracking and acquisition smoke should have the following characteristics :

- a. Be efficient on a weight and volume basis.
- b. Have the ability to function and perform at altitudes where pressure is low, and water vapor and oxygen concentrations are small.
- c. Have the ability to function through the range of temperatures encountered from ground temperature to the minimum high altitude temperature.
- d. Require little power for generation and dispersion.
- e. Be as nontoxic, nonexplosive, and noncorrosive as possible with regard to both smoke chemicals and products.

### 7-2.3.4 Smoke for Dissemination of Agents

Agent smokes for riot control and other purposes are produced in much the same way as colored signal smokes. In many cases, a vaporization process is followed by a condensation process in which the agent condenses to form the disperse phase of the smoke. Agent smokes may be disseminated by explosive means as well as by some

of the other methods discussed in Paragraph 7-3. The physiological effectiveness of materials disseminated in this way depends strongly on the particle size. While visibility of the smoke may or may not be important, the volume of smoke and its duration is important. It is also necessary that the vaporization and condensation process be efficient and produce a minimum of undesired changes in the agent being dispersed.

### 7-3 DISSEMINATION TECHNIQUES

Dissemination refers to the process by which a chemical agent is converted into a cloud consisting either of vapor or fine particles, suspended in the air. For agents, such as smoke, which are disseminated as a particulate cloud, the process usually involves the formation of small particles of the dispersed phase and the distribution of these particles in the air.

#### 7-3.1 FORMATION OF THE DISPERSED PHASE

The dispersed phase can be formed in two ways: (a) by condensation processes in which molecules of a vapor unite to form the particles of the dispersed phase, and (b) by dispersion processes in which the particles are formed by the breaking up of a solid or liquid material. In the first case, the specific surface (the total surface per unit-volume of the material) decreases; while in the second case, the specific surface increases.

##### 7-3.1.1 Vapor Condensation Processes

The dispersed phase of most particulate clouds is produced by condensation from the vapor phase and involves the uniting of vapor molecules to form larger particles. The formation of a dispersed phase by this method involves two steps: (a) producing the vapor in a supersaturated state, and (b) condensing the supersaturated vapor. The supersaturated vapor is usually obtained by: (a) the cooling of a warm vapor, or (b) a chemical reaction which results in the formation of a supersaturated vapor. In either case, the excess vapor will condense to form the particles of the dispersed phase. The condensation of a supersaturated vapor is accompanied by the liberation of heat so that this process will continue, once initiated, until equilibrium is reached.

The production of a supersaturated vapor and formation of a dispersed phase by condensation are complex processes and proceed essentially simultaneously. Consequently, little direct information has been obtained on the early stages of particle formation.

Condensation of a vapor is facilitated by the presence of foreign particles. Insoluble foreign particles can absorb a thin film of vapor on their surfaces and behave as liquid droplets of equal size. If the foreign particle is soluble in the condensed liquid, the vapor pressure of the liquid is decreased and, consequently, the supersaturation required for rapid condensation is reduced. Charged droplets, which are formed due to the presence of ions, tend to have a larger surface and, hence, a lower vapor pressure which result in condensation at a lower supersaturation. If condensation, in the absence of foreign particles, were to start from a single molecule, the theory indicates that a much higher supersaturation would be required than that observed experimentally. Therefore, it is postulated that small aggregates of molecules, of approximately the critical size, are continually produced by random fluctuation in the vapor. Molecular aggregates smaller than the critical size will disappear, while those larger than the critical size will continue to grow.

In many cases of military interest, the supersaturated vapor is produced by the evaporation of a substance, followed by the mixing with cooler air of the relatively warm vapors produced. Condensation then follows, resulting in the formation of the dispersed phase. The particles in a smoke produced as the result of combustion are also due to vapor condensation. In this case, due to the higher temperatures involved, it is impossible to analyze the process in detail. Chemical reactions, including several for producing smokes of military interest, often involve a component of the atmosphere (such as water vapor) as one of the reactants.

##### 7-3.1.2 Dispersion Processes

The formation of a dispersed phase by dispersion methods involves the subdivision of a solid or liquid into fine particles. The actual mechanisms by which the fine particles are produced and dis-

persed in the suspending medium are intimately related and not always completely understood. In the case of a liquid, energy applied to it causes the liquid to assume an unstable configuration which then breaks up into small droplets. A solid substance may be disrupted and dispersed into fine particles by application of energy, or the solid can be preground to the desired size and then dispersed into the suspending medium.

In the atomization of liquids, the energy is expended mainly in: (a) forming new surfaces, (b) overcoming viscous forces in changing the shape of the liquid, and (c) meeting losses due to inefficient application of the energy to the liquid. Devices commonly used to disperse liquids are of three main types.

One type employs a high velocity gas or air jet to break up a liquid emerging from a nozzle. Atomizers of this type produce a very wide range of droplet sizes which can be somewhat reduced by trapping the larger droplets within the atomizer. The degree of atomization obtained by this method is influenced by the following factors:

- a. The relative velocity of the air past the droplets.
- b. The physical properties of the liquid, including surface tension, viscosity, and density.
- c. The relative quantity of air expressed as the ratio of volume of air to volume of liquid.

Within a limited range, the Nukiyama Tanasawa equation applies, even though it is dimensionally incorrect.<sup>6</sup>

$$d_o = \frac{585\sqrt{\sigma}}{v\sqrt{\rho}} - 597 \left( \frac{\mu}{\sqrt{\sigma\rho}} \right)^{0.45} \left( \frac{1000Q_L}{Q_A} \right)^{1.5} \quad (7-6)$$

where  $d_o$  is the diameter in microns of a single drop with the same ratio of surface-to-volume as a representative sample of the atomized droplets;  $v$  is the velocity of the air in centimeters per second relative to that of the liquid;  $Q_L/Q_A$  is the volume-flow-rate of liquid to the volume-flow-rate of air;  $\rho$  is the density of the liquid in grams per cubic centimeter;  $\mu$  is the velocity of the liquid in poises; and  $\sigma$  is the surface tension in dynes per centimeter. This equation is used in estimating the performance of particulate cloud generators such as

the venturi nozzle type, where the smoke-producing material is atomized prior to evaporation.

There are two other important types of atomizers which are of somewhat lesser military importance. The first of these types is the centrifugal atomizer in which the liquid is fed onto the center of a rotating disc, cone, or top and centrifuged off the edge, producing droplets of relatively uniform size. In the second type, the hydraulic atomizer, liquid is forced through a nozzle and is broken up into droplets. In this latter case, the atomization depends more on the physical properties of the liquid and the conditions of ejection from the nozzle than on the interactions between the liquid and the surrounding gas.

Dusts can be formed by the disruption of solid material or by the dispersion of a material, finely preground to a desired size.

The forces required to disrupt the solid material may be applied rather slowly by milling, crushing, or grinding, or rapidly through explosion or impact. In either case, the applied forces cause disintegration by splitting or cracking along planes of weakness in the material. The result is the formation of small fragments and fine particles released from the freshly formed surfaces by cracking on a microscale as the material is torn apart.

### 7-3.1.3 Combined Processes

Since mist dispersion methods will not produce particles of the correct size, in many cases the dispersed phase for smokes of military interest is obtained by condensation from a vapor phase which is formed by evaporation of the smoke-producing agent. However, in order to facilitate the transfer of heat to and the removal of the vapor from the surface of the agent, it is often atomized before it is evaporated. Particulate clouds can be developed by the atomization of a solution containing a nonvolatile or slightly volatile solute in a volatile solvent. The solvent evaporates and leaves the solute which condenses to form the dispersed phase of a particulate cloud. The explosive dispersion of volatile materials, such as the dyes used for colored smoke, is also a combined process. The explosion mechanically disperses, vaporizes, and

mixes the material with cooler air, resulting in the formation of a particulate cloud.

### 7-3.2 MILITARY PRODUCTION OF SMOKE

Pyrotechnic munitions for producing smoke, whether for screening, signaling, or other purposes, are usually one of the following general types:

- a. Venturi Thermal Generator Type. The smoke-producing material and the pyrotechnic fuel block required to volatilize the smoke material are in separate compartments. The smoke-producing material is atomized and vaporized in the venturi nozzle by the hot gases formed by the burning of the fuel block.
- b. Burning Type. Burning-type smoke compositions are intimate mixtures of chemicals. Smoke is produced from these mixtures by either of two methods. In the first method, a product of combustion forms the smoke or the product reacts with constituents of the atmosphere to form a smoke. In the second method, the heat of combustion of the pyrotechnic serves to volatilize a component of the mixture which then condenses to form the smoke.
- c. Explosive Dissemination Type. The smoke-producing material is pulverized or atomized and then vaporized, or a preground solid is dispersed by the explosion of a bursting charge.

It is to be noted that smoke is also produced for military purposes by other than pyrotechnic means. For example, certain screening-smoke materials can be disseminated by mechanical smoke generators and others by the use of airplane spray tanks. Signals and tracking aids can be generated by using hot exhaust gases from aircraft or tank engines to vaporize the smoke-producing materials.

The ingredients used in smoke-producing chemicals and combustion products, and/or the condensed vapor particles produced in a smoke, should be considered to be irritating and/or toxic. Care should be exerted in working with smoke-producing materials and the resulting smokes, especially regarding the inhalation of high concentrations and long exposures thereto. When investigating new

materials the proper references should be consulted<sup>14,15,16,17</sup> and if little or no information is available, extreme caution should be exerted.

The remaining sections of this chapter emphasize production of smoke by pyrotechnic means; however, the same principles are applicable to other methods for producing smoke, some of which are briefly discussed.

### 7-3.3 WHITE SMOKES

White smokes are widely used for screening, acquisition and tracking, fire control, and signaling purposes. They can be produced from many chemicals in a variety of ways and, in general, are more efficient on a weight basis than colored smokes.

Relatively few of the methods for producing white smoke are of value for production of the large amount of smoke required for screening purposes which is one of the important uses for white smoke. Because of the large amount of smoke required, it is important that the maximum effect be obtained per unit-weight of smoke-producing material. This will depend on: (a) the weight of the material available to form smoke particles, whether this was originally present in the mixture or is contributed from the atmosphere, and (b) the efficiency of conversion of the smoke-producing material into smoke particles having the optimum light-scattering and obscuring capability.

Formation of smoke particles by condensation from the vapor phase is the only practical way to produce the large amount of white smoke required for military screening purposes. The hot vapor is usually produced by volatilization or by chemical reactions in which one reactant is normally a component of the atmosphere. Examples of the three most widely used screening smokes are:

- a. Oil smoke, which is produced by the volatilization and condensation of oil.
- b. White phosphorus smoke, which is produced by chemical reaction with the atmosphere.
- c. Zinc chloride smoke, which is produced by a combination of volatilization and chemical reaction.

Oil smokes are normally produced by venturi-type thermal generators, although intimate mixture burning types of munitions have been de-

veloped for dissemination of oil smoke. Zinc chloride smoke is produced by a burning-type munition. White phosphorus smoke for screening is normally produced by a bursting-type munition.

### 7-3.3.1 Oil Smoke

A very satisfactory white screening smoke can be produced by the vaporization and condensation of an oil that has a high boiling point and a low volatility. The first successful generator for producing oil smoke was the M1 mechanical smoke generator. In this generator the smoke oil was flash evaporated at a relatively high temperature, with water added to prevent coking. The equipment was heavy and complicated, including gasoline engines to operate the necessary pumps and blowers, coils for the evaporation of oil and water, and burners using fuel oil to heat the coils. In spite of their many disadvantages, these generators, along with similar types, were widely used during World War II.

#### 7-3.3.1.1 Venturi Thermal Generators

Toward the end of World War II another smoke generator, the Hessien, was developed for the U. S. Navy in which the fog oil was atomized, mixed with the hot gases produced by the combustion of a fuel, and vaporized in a venturi throat. The development of venturi-type thermal-generator munitions using pyrotechnic fuel blocks was also accomplished during World War II; however, these items were not fully ready for production until after the War.

##### 7-3.3.1.1.1 Operation of Venturi Thermal Generators

The operation of a venturi-type thermal generator to produce a smoke involves the atomization of the liquid, the vaporization of the droplets produced, and the dispersion of the vapor in a stream of hot gases. A typical unit, shown schematically in Figure 7-3, consists of:

- a. a fuel block which, on burning, produces the hot gases,
- b. a chamber containing the liquid to be vaporized and dispersed, and
- c. a high velocity vaporizer tube in the form of a venturi.

A pressure tube connects the agent compartment and the fuel compartment and permits the pressure developed by the fuel block to aid in forcing oil through an orifice into the venturi throat. Here the oil is mixed with the hot gas stream flowing through the venturi. The high velocity of the gases promotes atomization of the incoming oil stream and the droplets are quickly vaporized. The rate of feeding is governed by the pressure differential between the agent compartment and the throat, the size of the feed orifice, and, to a minor extent, the resistance to the flow through the feed tube. Little decomposition of the agent is caused by the relatively high temperatures required for rapid evaporation due to the short period of exposure. The efficiency of this type of generator is highest when the agent is heated to a rather high temperature for the shortest possible time rather than a lower temperature for a longer period. The particle size of a smoke produced in a venturi thermal-generator type of munition can be defined in terms of: (a) the Nukiyama Tanasawa equation (Equation 7-6), modified to include the effect of system heat upon the aerosol, and (b) the thermodynamic properties of both the liquid and the pyrotechnic combustion products at the point of mixing, which controls the amount of liquid vaporized. Thus, the smoke formed can be considered to be made up of two parts: the larger particles produced predominantly by the atomization process, and smaller particles produced by vaporization and condensation.

The portion of the liquid vaporized depends on the heat transferred from the hot gases. The amount vaporized is significantly affected by mass flow rates, mean specific heat, and initial gas temperature. With proper design of the venturi, there is sufficient time for the heat to be transferred from the gases to the liquid. The overall process in the venturi can be considered to be essentially adiabatic.

Generators of this type regulate particle size through rapid dilution of the vapor with cool air. As mixing and cooling occurs, the saturated vapor condenses. For oil smokes, a very rapid coagulation occurs for a very short period of time causing the particles to grow. Dilution, however, occurs so rapidly that the coagulation is checked after a few

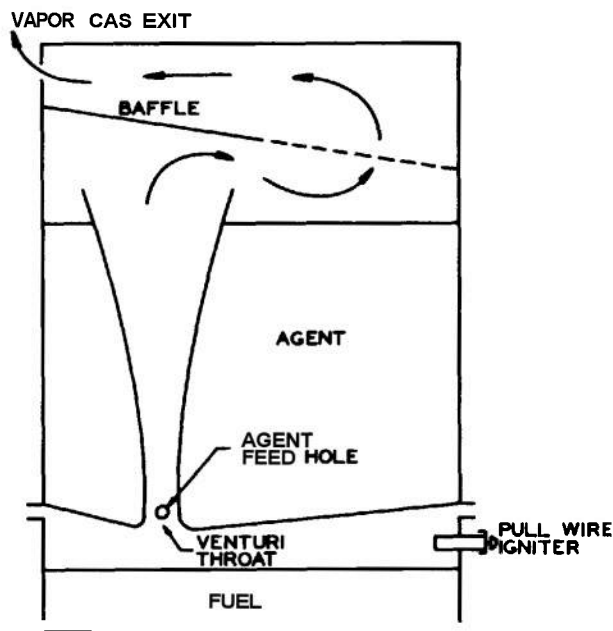

Figure 7-3. Typical Venturi Thermal Generator

thousandths of a second, and a remarkably narrow range of particle sizes results. If the generator is working well, it is possible to obtain a rough check on the particle-size range by a simple color test. If the sun's disc or any other bright light source, when almost obscured, appears red, the particle size is somewhat smaller than desired; if it appears magenta, the particle size is satisfactory; if it appears blue, the particle size is larger than desired for maximum screening effectiveness. If the smoke produced is not of a uniform particle size, the sun's disc will appear white and no conclusion can be drawn as to particle size being produced by the generators.

7-3.3.1.1.2 Fuel Blocks<sup>4,18</sup>

The heat and product gases produced by the burning of a pyrotechnic fuel block must:

- a. Raise the temperature of the oil to the vaporization temperature.
- b. Supply the latent heat of evaporation to the oil.
- e. Supply the heat lost as sensible heat in the hot gases and hot container.

- d. Supply the carrier gas to remove the oil vapor.

Ammonium nitrate-charcoal compositions have proved to be a satisfactory fuel block for the volatilization of fog oil.

The reaction between ammonium nitrate and carbon can be written:

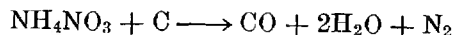

if it is assumed that all the carbon is oxidized to carbon monoxide. If all the carbon is assumed to be oxidized to carbon dioxide the reaction is:

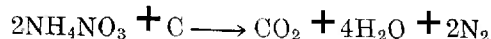

The volume of gas, measured at 0°C and 760 mm Hg, is about 0.97 liter per gram of mixture for the first reaction and 0.92 liter per gram for the second reaction.

Analysis of the gases produced by the burning of a typical ammonium nitrate fuel block (11 parts charcoal, 3 parts linseed oil, and 83 parts ammonium nitrate) gave the following:

H <sub>2</sub> O	48.8%	CO <sub>2</sub>	13.5%
NH <sub>3</sub>	0.6%	CO	5.2%
N <sub>2</sub>	26.1%	H <sub>2</sub>	5.8%

which corresponds, approximately, to the reaction:

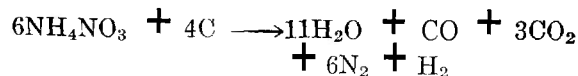

As illustrated in Chapter 3, this reaction should yield nearly one liter of gas, measured at 0°C and 760 mm Wg, per gram of mixture burned. Approximately 0.685 kcalories per gram of mixture is evolved when the mixture is burned.

Fuel blocks can be pressed using a binder, or they can be cast. In either case, the burning rate, which determines the heat and gas evolution rates, is roughly proportional to the area of the burning surface. For a fixed burning area, the rate of burning can be changed by:

- a. Varying the size of the charcoal,
- b. Modifying the surface of the charcoal, and/or
- c. Changing the composition of the fuel block.

Carbon is normally the least-uniform ingredient and, therefore, causes most of the variation

**TABLE 7-2**  
**CHARACTERISTICS OF TYPICAL OIL SMOKE POTS**

<i>Characteristic</i>	<i>Type Device</i>	
	<i>Floating (Fig. 7-3)</i>	<i>Training (Fig. 7-4)</i>
<i>Size, in.</i>	13 high by 13 dia.	5.7 high (including fuze) by 2.5 dia.
<i>Venturi Orifice</i>		
<i>Diameter, in.</i>	0.0890	0.076
<i>Weight, lb</i>	14.5 (oil) 12.0 (fuel)	0.24 (oil) 0.22 (fuel)
<i>Oil Agent</i>	SGF No. 1 or 2	SGF No. 1 or 2
<i>Fuel Block Composition</i>	<i>Past-Burning Top Mixture</i> 86% NH <sub>4</sub> NO <sub>3</sub> 11% Charcoal 3% Linseed Oil	82% NH <sub>4</sub> NO <sub>3</sub> 11% Charcoal 4% KNO <sub>3</sub> 3% Linseed Oil
	<i>Slow-Burning Base Mixture</i> 82% NH <sub>4</sub> NO <sub>3</sub> 8% NH <sub>4</sub> Cl 7% Charcoal 3% Linseed Oil	
<i>Ignition</i>	Bouchon fuze (M208) "spits" through venturi igniting yquickmatch & starter	Bouchon fuze (M201A1) (similar to floating type)
<i>Burning Time, min</i>	12 ± 1.5	1.2 ± 0.25
<i>Application</i>	Screening, used singly or in multiple on land or water	Grenade type, used for training purposes
<i>Obscuring Power</i>	- - -	Single pot fills a 13,000 cu ft room and totally obscures objects 4-6 feet away.

in burning for supposedly identical fuel blocks. Treatment of the carbon with chemicals (such as potassium carbonate or similar alkali chemicals) increases the burning rate while treatment with an acid will decrease the burning rate. The substitution of potassium nitrate, sodium nitrate, or ammonium chlorate for part of the ammonium nitrate will cause an increase in burning rate. A reasonable explanation for the increase is that these compounds form carbonates when burned

with charcoal. On the other hand, adding ammonium chloride or substituting naphthalene (or starch in a cast fuel block) for charcoal will reduce the burning rate.

An increase in either the initial temperature or the pressure in the fuel block chamber will also increase the burning rate. Surging (a rapid burning with a high rate of gas evolution followed by slower burning with a low rate of gas evolution) is sometimes observed. This objectionable cyclic be-

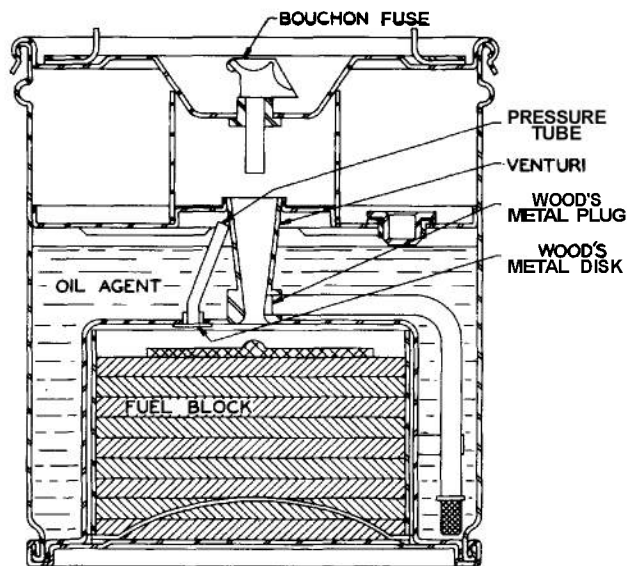

Figure 7-4. Typical Oil Smoke Pot (Floating)

havior is probably due to variations in the charcoal used inasmuch as surging is favored when a blend of slow- and fast-burning charcoal is used to make the fuel block.

Because charcoal may cause undesirable variations in the burning characteristics of a fuel block, attempts have been made to develop a fuel block which does not contain charcoal. A mixture of guanidine nitrate, ammonium nitrate, linseed oil, and ammonium dichromate was found to be only partially satisfactory. Reasonable success was obtained using polysulfide ammonium perchlorate as a binder and a substitute for all or part of the carbon in a castable fuel block. This reduced or eliminated the swelling and cracking observed in standard ammonium nitrate-carbon fuel blocks.

#### 7-3.3.1.1.3 Typical Venturi Thermal Generators

Characteristics of typical venturi-type thermal generators are given in Table 7-2. Figures 7-4 and 7-5 illustrate schematically two types of oil fed smoke pots.

#### 7-3.3.1.2 Other Methods for Producing Oil Smoke

Before the development of the M1 smoke generator, common methods for producing oil-based smoke screens included the reduction of air supply to the boilers of naval ships, the use of smudge

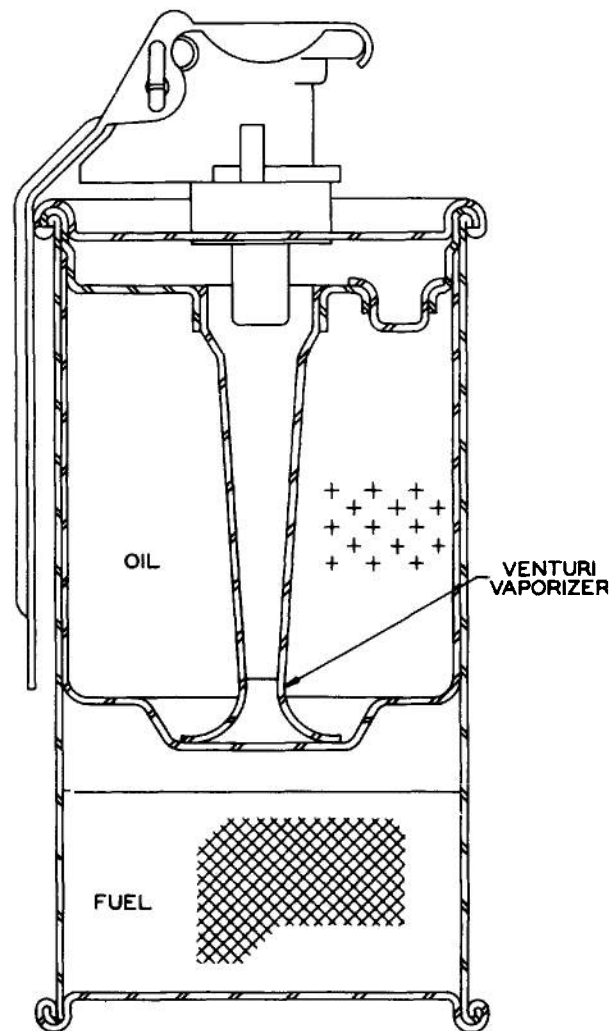

Figure 7-5. Typical Oil Smoke Pot (Training)

pots similar to those used in orange groves in the United States, and the Hasler generator developed and used by the British in the Battle of Britain. In all cases, the smoke produced was brownish-gray to black in color because the oil was partially decomposed thus yielding free carbon. In general, the smoke produced had poor screening properties and limited persistence.

Two oil smoke generator mixes which were reasonably satisfactory were developed during World War 11. The first was a mixture of sawdust and charcoal impregnated with a solution of potassium chlorate and a high-boiling point oil (Diol) which had been jelled by the addition of



a small percentage of soap. The other mixture consisted of jellied oil and black powder. In each case, the ideal mixture was one in which all of the fuel but none of the oil was oxidized, and in which the amount of heat produced was sufficient to vaporize all of the oil. The smoke exit orifice was important in controlling the flaming tendency of the mixture, the particle size of the smoke produced, and the pressure within the smoke pot.

Considerable effort was directed toward the development of smoke generators, using the sensible heat in exhaust gases from vehicle and aircraft engines for the evaporation of oil to form screening smoke. Results indicated that the amount of smoke produced was not adequate for screening purposes but was adequate for signaling. In an attempt to increase the amount of smoke produced, the exhaust gases were burned in an afterburner, thereby increasing their temperatures and heat content. With this modification, satisfactory smoke screens were produced by aircraft using internal combustion engines.

### 7-3.3.2 Phosphorus Smokes

White smoke consisting of small droplets of phosphoric acid have been widely used for military purposes. These droplets result from the reaction of phosphorus pentoxide, formed by the burning of phosphorus or phosphorus-containing compounds in the air, and the water vapor in the air, or:

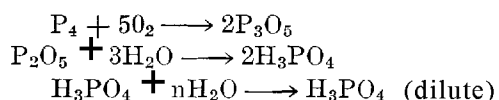

The concentration of phosphoric acid in the droplets is determined by the relative humidity. Methods which have been used to form phosphorus pentoxide for military smokes utilizing phosphorus include:

- burning in air of white phosphorus (which is spontaneously flammable),
- burning in air of the phosphorus vapor (produced by the evaporation of red phosphorus in a fuel-oxidant mixture), and
- burning in air of phosphine (produced by the action of a metal phosphide with water).

Phosphorus vapor is extremely toxic and causes bone decay; however, it is not present after the

smoke is formed. Phosphorus pentoxide and phosphoric acid are not toxic in small concentrations, although they may be irritating to the eyes, respiratory tract, and skin. Phosphorus smokes have relatively little effect on metals.

### 7-3.3.2.1 White Phosphorus

White phosphorus is widely used in bursting-type munitions to produce smoke screens for ground-combat operations, and for signaling and spotting purposes. Slow-burning fragments of white phosphorus, produced and spread by an explosive burster, are incendiary while burning. Since burning white phosphorus produces flesh burns which are slow to heal, it is an excellent harassing agent.

White phosphorus is the most efficient smoke producer on a weight basis; however, the screening effectiveness of white phosphorus in bursting-type munitions is slight. Most of the charge burns within seconds following the burst, resulting in a smoke concentration many times that required for effective screening. In addition, the temperature rise in the cloud immediately surrounding the burst is sufficient to produce a strong thermal up-draft which rapidly lifts the cloud from the ground so that the smoke cloud pillars. This may be helpful for signaling purposes but generally reduces the effectiveness of white phosphorus as a screening smoke.

Two general ways to improve smoke-producing efficiency are possible. The first involves reduction of the heat of combustion, which can be accomplished only by using different phosphorus compounds. The second method, which is more attractive, involves controlling the rate of combustion by reducing the fragmentation of the phosphorus. Several methods for controlling the fragmentation of phosphorus have been tried, including the addition of mechanical reinforcement such as steel wool,<sup>19</sup> asbestos, plastic tubes, wire screens, and other devices, causing ejection of the phosphorus in pieces of predetermined size. Other methods attempted involve the alteration of the physical properties of phosphorus so as to produce a plastic mass with low shattering characteristics.

Plasticized white phosphorus,<sup>20</sup> PWP, was found to be the most promising development for

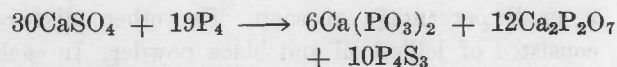

Figure 7-6. Typical WP-Filled Device (M15 WP Smoke Hand Grenade)

control of the fragmentation of phosphorus and pillaring of the smoke. This consists of an intimate mixture of granulated white phosphorus in a viscous rubber solution. The material burns more slowly and the particles do not disintegrate by melting. As a result, pillaring is reduced and the effective screening time is greatly prolonged. Test results have indicated that plasticized white phosphorus produces distinctly better smoke screens than similar phosphorus-filled rounds. The anti-personnel incendiary action of PWP is as good as that of WP.

#### 7-3.3.2.2 Burning-Type Mixtures Containing Red Phosphorus

Red phosphorus, the comparatively inert allotropic form of phosphorus, is used in burning-type munitions mainly for signaling purposes. Compositions consisting of red phosphorus and certain oxidants or fuels are relatively slow-burning and are sometimes used in sea markers. The chemical reactions may be quite involved. For example, the main reaction for a burning mixture of calcium sulfate and red phosphorus appears to be:



The heat produced by this reaction vaporizes the remaining red phosphorus contained in the smoke mixture. The phosphorus vapor burns on contact with air. Some sulphur dioxide is formed when the  $\text{P}_4\text{S}_3$ , produced in the above reaction, burns along with the phosphorus vapor:

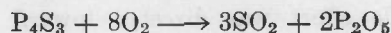

In the presence of moisture, there is a tendency for red phosphorus to slowly oxidize due to the presence of small quantities of copper and iron. This may result in ignition difficulty and an overall decreased performance of the smoke item. Stable red phosphorus has been produced by decreasing or eliminating these impurities.<sup>21,22,23</sup>

#### 7-3.3.2.3 Metal Phosphides

Metal phosphides, especially calcium phosphide, which was first produced commercially in 1920, have been used in sea markers. In these markers the metal phosphide reacts with water to form phosphine, which then burns in air to produce phosphorus pentoxide and water. For calcium phosphide:

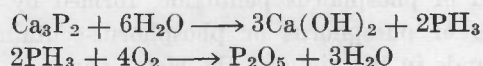

The rate of reaction is governed by the access of the water and by the back pressure of the gas produced. Calcium phosphide has been the most satisfactory for this purpose. Aluminum phosphide is difficult to react and is slow-burning, whereas magnesium phosphide reacts too rapidly.

#### 7-3.3.2.4 Other Reactions for Producing Smokes Containing Phosphorus

Other methods for producing phosphorus-containing smokes include:

- a. The dispersion of phosphorus in a solvent such as carbon tetrachloride or carbon disulfide. The solvent evaporates and the finely divided phosphorus burns in the available oxygen and produces a dense white smoke.
- b. The reaction of phosphorus trichloride with bases such as ammonia and amines. The

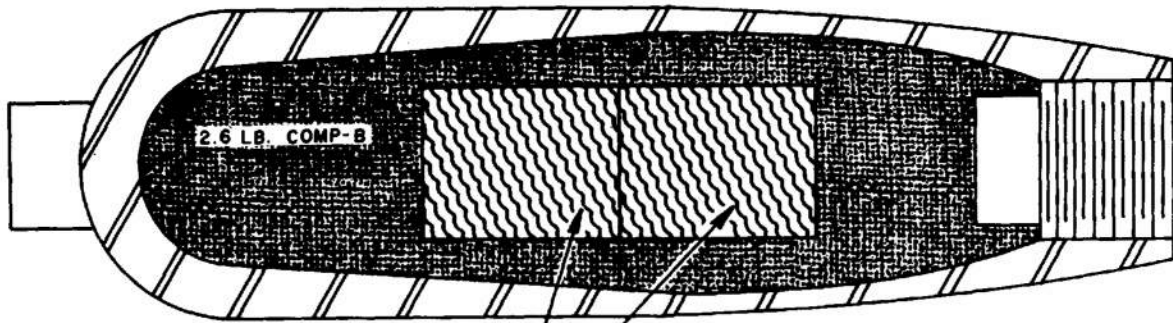

0.33 LB. STABILIZED RED PHOSPHORUS IN EACH OF TWO ALUMINUM SUPPLEMENTARY CHARGE CONTAINERS. TOTAL SMOKE CHARGE: 0.66 LB.

Figure 7-7. Typical Red Phosphorus-Filled Device

reactions are complex as illustrated in the following example:

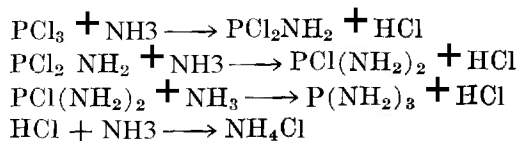

The smoke is composed of a mixture of aminophosphorus chlorides and  $\text{NH}_4\text{Cl}$ ; the smoke produced is considered irritating but not toxic; phosphorus trichloride is not excessively corrosive to any metal affected by hydrochloric acid; either wet or dry it is quite corrosive to flesh.

- e. The dispersion of phosphorus sulfides in carbon bisulfide. The solvent evaporates and the finely divided particles of phosphorus sulfide burn readily in air; total combustion of these sulfides yields phosphorus pentoxide and sulphur dioxide:

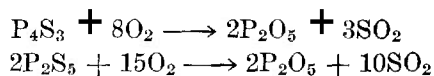

Both products react with water to produce sulfurous acid and phosphoric acid; the sulfides of phosphorus are harmless to both metals and flesh. The smoke produced is also relatively harmless to metals and personnel under normal conditions; however, prolonged exposure to high concentrations should be avoided.

### 7-3.3.2.5 Typical Devices

The characteristics of typical smoke-producing devices containing phosphorus are summarized in Table 7-3. Illustrations of such devices are shown in Figures 7-6 and 7-7.

### 7-3.3.3 Metal Chloride Smokes

A large number of metal chlorides have been used to produce white smoke. All of the metal chlorides react with water to varying degrees and this characteristic determines, to a large extent, their efficiency as smoke agents. While the methods by which they are disseminated depend on the particular metal chloride, once disseminated the metal chloride reacts with the water vapor in air resulting in the formation of hydrated oxides, or hydroxides and hydrochloric acid.

#### 7-3.3.3.1 Liquid Metal Chlorides

The liquid metal chlorides can be disseminated by thermal vaporization followed by condensation, or by atomization. FM, a commercial form of titanium tetrachloride, has probably been the most widely used liquid metal chloride smoke agent.

##### 7-3.3.3.1.1 FM Smokes

FM smoke agent,  $\text{TiCl}_4$ , is extremely reactive resulting in the formation of hydrated oxides, or with atmospheric moisture and, when used for screening, is often disseminated from aircraft

TABLE 7-3  
CHARACTERISTICS OF TYPICAL DEVICES USING  
PHOSPHORUS FILLING

<i>Characteristic</i>	<i>Device</i>	
	<i>WP Smoke Hand Grenade (M15)</i>	<i>Projectile (T91 HE Water Marker)</i>
<i>Size, in.</i>	4½ high 2¾ dia.	12¾ long 1¾ dia.
<i>Charge Weight</i>	15 oz PWP	2.6 lb Comp. B. 0.66 lb Stabilized Red Phosphorus
<i>Ignition</i>	M206A1 fuze HE burster	M500A1 fuze Comp. B
<i>Screening Capability</i>	Scatters WP over a 20 yd radius	Explodes on impact—50 ft high ; 50 ft dia ; cloud duration 3 min—25 mph wind
<i>Application</i>	Thrown, bursting charge explodes, 4-5 sec delay.	Used in 90 mm munition (white marker)

spray tanks.<sup>24</sup> Its reaction with water vapor is relatively complex. First, the titanium tetrachloride is hydrated. This reaction is followed by further hydrolysis yielding, finally, titanium hydroxide and hydrochloric acid. The smoke consists of a mixture of fine particles of solid titanium hydroxide,  $Ti(OH)_4$ ; the hydrated oxide,  $TiO_2 \cdot H_2O$ ; intermediate hydroxychlorides of titanium; and dilute HCl droplets. The sequence of reaction is:

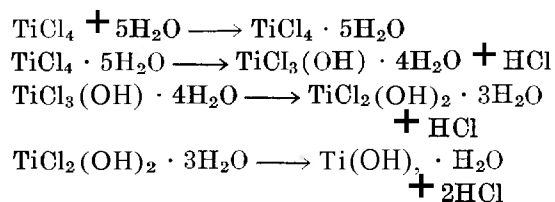

Liquid FM is excessively corrosive to metal if moisture is present. With moisture, FM forms a solid, gummy deposit that clogs equipment. A 0.2 percent phosphorus solution in  $CS_2$  and  $CCl_4$ , added to the FM, alleviates this problem.

Titanium tetrachloride can also be disseminated

when dissolved in dichloroethane and similar materials. The solvent evaporates and the titanium tetrachloride reacts with the water vapor in the air to produce smoke.

#### 7-3.3.3.1.2 Silicon Tetrachloride

Silicon tetrachloride is another liquid metal chloride which has been used to produce smoke. Silicon tetrachloride is, however, less reactive than titanium tetrachloride and, unless considerable moisture is present, little smoke is produced. The smoke particles produced from the reaction of silicon tetrachloride with water vapor are dilute hydrochloride acid droplets and hydrated silicon oxide. The reaction between silicon tetrachloride and water vapor is similar to that for titanium tetrachloride.

Silicon tetrachloride is less corrosive to metals than titanium tetrachloride. If dry, it can be stored in aluminum or steel containers. With moisture, silicon tetrachloride forms a gummy deposit which clogs equipment. Flesh burns from

silicon tetrachloride are similar to hydrochloric acid burns.

#### 7-3.3.3.1.3 Stannic Chloride

Stannic chloride will produce a good smoke from relatively small amounts of material. The reactions of stannic chloride with water vapor are similar to those of titanium tetrachloride. The smoke is composed of HCl droplets and a mixture of four stannic hydroxy chlorides. In the presence of moisture they are nearly as corrosive as titanium tetrachloride. A gummy deposit on metals is formed by stannic chloride when moisture is present. The smoke is corrosive to anything affected by hydrochloric acid. Stannic chloride produces burns similar to strong acid burns.

#### 7-3.3.3.2 Solid Metal Chlorides

Solid metal chlorides are normally disseminated by thermal vaporization followed by condensation. In most cases, the energy required to vaporize these agents is provided by a pyrotechnic heat source. The hydrolyses reactions for the metal chlorides which have been used as smoke agents are:

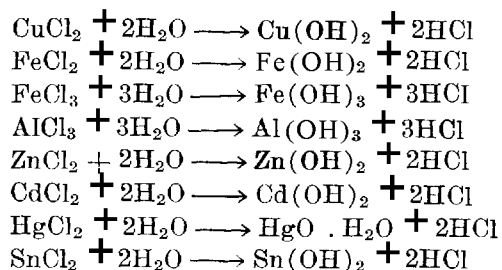

#### 7-3.3.3.2.1 HC Smokes

Zinc chloride is one of the most reactive of the solid metal chlorides used as a smoke agent. Although toxic, zinc chloride produced as the result of a pyrotechnic reaction is widely used for screening and signaling purposes.<sup>15</sup> Inasmuch as hydrochloric acid is produced by the reaction between zinc chloride and water vapor in air, the smoke is irritating to personnel and will react with any materials affected by hydrochloric acid.

The French, during World War I, were the first to produce a smoke mixture of this type. The mixture known as the Berger mixture consisted of zinc, carbon tetrachloride, zinc oxide, and kiesel-

guhr. The last two ingredients served to absorb the carbon tetrachloride and to slow down the rate of reaction. As the smoke produced contained some carbon in addition to the zinc chloride, it was somewhat gray in color. An American improvement, the addition of an oxidizing agent, resulted in a whiter smoke. Other changes were made leading to the development of the smoke mixture, available at the start of World War II, known in the United States as HC. This mixture contained hexachloroethane as the chlorinating agent, zinc as the fuel, a perchlorate as an oxidizing agent, and ammonium chloride as a retarder. The British had a similar mixture containing hexachloroethane, zinc oxide, and calcium silicide as a reducing agent. Since neither of these mixtures was completely satisfactory early in World War II, the British mixture was modified by replacing the reducing agent, calcium silicide, with aluminum.

#### 7-3.3.3.2.2 Chemistry of HC Smoke Mixtures<sup>25,26</sup>

The basic reaction between a completely chlorinated carbon compound and metallic zinc can be represented by the reaction:

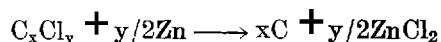

This reaction is highly exothermic with the evolution of 165.3 kilogram-calories or 581 gram-calories per gram of mixture if carbon tetrachloride is used, and 244.6 kilogram-calories or 565 gram-calories per gram of mixture if hexachloroethane is used as the chlorinating agent. If zinc oxide is added, the mixture will burn more slowly. The smoke produced is whiter due to the reaction between zinc oxide and carbon:



which removes the carbon from the smoke. The zinc produced by this reaction then reacts with additional amounts of the chlorinating agent. As the reaction between zinc oxide and carbon is endothermic, early attempts to use zinc oxide in HC-type smokes were only partially successful since the temperature reached was not high enough to cause complete reduction of the zinc oxide.

As the result of modifications made during the early part of World War II, HC smoke mixtures—as normally compounded for screening purposes

—now consist of approximately equal amounts by weight of zinc oxide and a chlorinating agent such as hexachloroethane or carbon tetrachloride, and a few percent of aluminum. The reaction might proceed through the following steps, when hexachloroethane is the chlorinating agent :

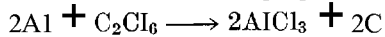

This reaction is exothermic, liberating around 280 kilogram-calories of energy. The aluminum chloride formed then reacts with the zinc oxide:

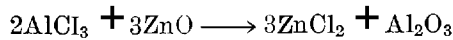

This reaction is also exothermic, liberating 103.0 kilogram-calories. The overall reaction obtained by combining the above reactions is:

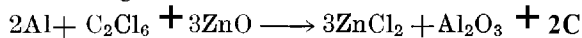

This reaction is highly exothermic, liberating 383.5 kilogram-calories or 717 gram-calories per gram of smoke mixture. A second reaction sequence leading to the same overall reaction is possible. This sequence, which to some investigators better represents the actual course of the reaction, is:

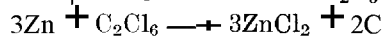
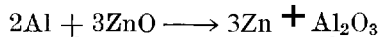

Both of these reactions are exothermic, the first to the extent of 136.6 kilogram-calories, and the second to the extent of 219.8 kilogram-calories. The overall reaction with aluminum is similar to the reaction :

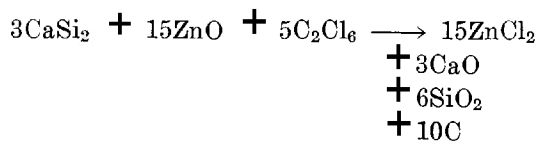

for the earlier smoke mixture containing calcium silicide as the reducing agent.

The extent of the reaction between zinc oxide and carbon can be varied by changing the proportion of aluminum in the smoke mixture. If the aluminum content in the smoke mixture is reduced, while the proportions of hexachloroethane and zinc oxide are kept constant, the amount of free carbon in the smoke is reduced. This results in a whiter smoke and also reduces the burning rate. The overall reaction where no carbon is produced is:

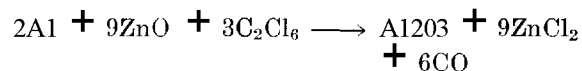

The amount of aluminum in the foregoing reaction can vary from 3.6 to 10.1 percent by weight. With the lower aluminum content, only carbon monoxide is formed; and, as the aluminum content is increased, free carbon begins to appear along with the carbon monoxide until at the upper limit all the carbon is in the form of smoke. If less than 3.6 percent of aluminum is used, both carbon dioxide and carbon monoxide are produced; and, as the percentage of aluminum is still further reduced, the ratio of carbon dioxide to carbon monoxide increases. The heat evolved varies from 356 gram-calories per gram of a smoke mixture containing 3.6 percent of aluminum to 717 gram-calories per gram of mixture containing 10.1 percent aluminum content. If carbon tetrachloride is used (Type-E HC mixture) instead of the hexachloroethane, the amount of aluminum for similar reactions to take place ranges from 5.37 percent to 10.2 percent. The variation in burning time with aluminum content, for mixture containing hexachloroethane (Type-C HC mixture), is illustrated by the data presented in Table 7-4.

**TABLE 7-4**  
**VARIATION OF BURNING TIME OF TYPE-C**  
**HC SMOKE MIXTURE WITH**  
**ALUMINUM CONTENT**

(AN-M8, HC SMOKE GRENADE)	
<i>Aluminum Content,</i> %	<i>Burning Time,</i> <i>sec</i>
9.0	55
8.4	64
8.0	65
7.5	71
7.0	84
6.5	96
6.0	107
5.5	147
5.5	200

The character of the zinc oxide also has an influence on the burning rate of the smoke mixture. HC smoke grenades which were loaded with a smoke mixture containing 6.25 percent aluminum, 46.9 percent hexachloroethane, and 46.9 percent



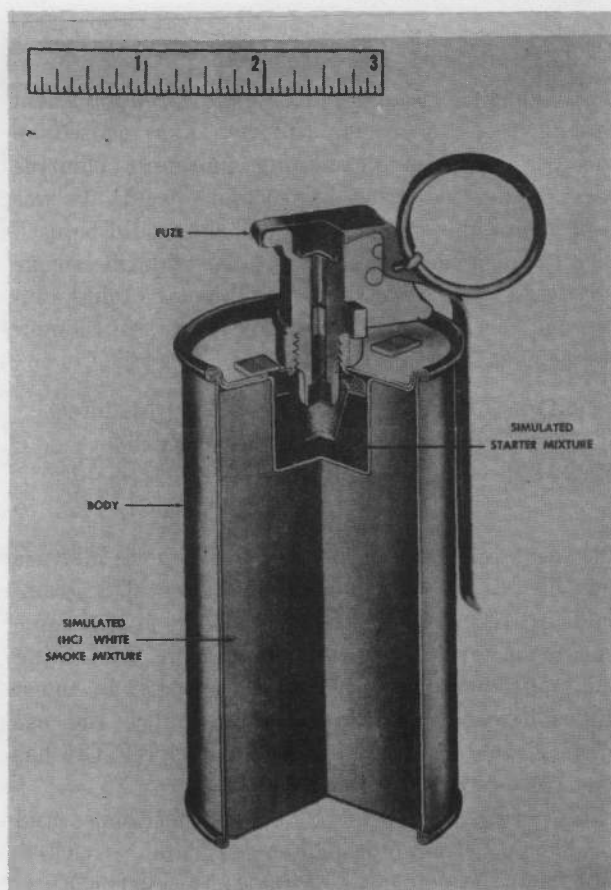

Figure 7-8. AN-M8 HC Smoke Hand Grenade

and marking purposes. Heat of combustion and differential thermal analysis have indicated that three chemical reactions are basically responsible for the preignition, ignition, and combustion phases of this ternary system.<sup>31</sup> These reactions are:

1.  $3\text{Zn} + \text{C}_6\text{Cl}_6 \longrightarrow 3\text{ZnCl}_2 + 6\text{C}$
2.  $4\text{C} + \text{KClO}_4 \longrightarrow \text{KCl} + 4\text{CO}$  (and  $\text{CO}_2$ )
3.  $4\text{Zn} + \text{KClO}_4 \longrightarrow \text{KCl} + 4\text{ZnO}$

The agreement between the measured and calculated heats of combustion based on these reactions is good.

The first of these reactions is a relatively slow, exothermic reaction which takes place at, and above, the boiling point of hexachlorobenzene to produce carbon. Carbon, which is produced at a

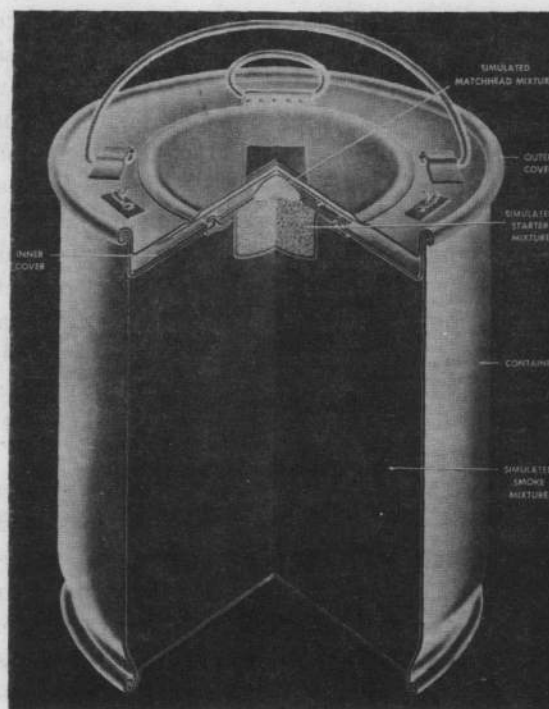

Figure 7-9. M5 HC Floating Smoke Pot

temperature above the transition point of potassium perchlorate, reacts with the latter at the boiling point of hexachlorobenzene, according to reaction 2. The latter reaction, together with reaction 1 to a limited extent, raises the system to a temperature above  $500^\circ\text{C}$ . At temperatures above the melting point of zinc ( $419^\circ\text{C}$ ), the preignition reaction 3 becomes highly exothermic and propagation ensues in the range of  $520^\circ\text{C}$ . Therefore, the production of carbon by reaction 1 is an important factor in the sensitivity of this composition to thermal ignition.

#### 7-3.3.3.5 Typical Devices

Typical devices using HC type smoke mixtures are shown in Figures 7-8 and 7-9. Details and specifications for these devices are contained in Table 7-5.

#### 7-3.3.4 Sulfuric Acid Smokes

Several white smokes are made up, at least in part, of droplets of dilute sulfuric acid result-



TABLE 7-5  
CHARACTERISTICS OF TYPICAL DEVICES USING HC MIXTURE

<i>Characteristic</i>	<i>Device</i>	
	<i>HC Smoke Hand Grenade (AN-M8)</i>	<i>HC Floating Smoke Pot (M4A2)</i>
<i>Size, in.</i>	5.7 high 2.5 dia Four smoke emission holes in top	13 high 12 dia Three vent holes in top
<i>Charge Weight Ignition</i>	19 oz Type-C HC Mixture M201A1 fuze plus ignition mix and starter mix	23.5 to 27.5 lb HC Mixture M207A1 fuze plus first fire charge and delay charge
<i>Burning Time Application</i>	105-150 sec  Thrown, 1.2-2 sec delay — may be launched from rifle or carbine for screening or marking.	10-15 min  Screening

ing from the reaction of the smoke-producing chemical with water vapor in the air. In a number of cases, because of the presence of chlorine atoms in the original compound or mixture, dilute hydrochloric acid droplets are also produced. In this category, the FS smoke mixture of chlorosulfonic acid and sulfur trioxide, which is used for screening, is probably the most important. Prolonged exposure to this type smoke can be injurious and should be avoided.

#### 7-3.3.4.1 Sulfide Trioxide

This agent is usually dispersed into the atmosphere in fine particles either by mechanical atomization or thermal vaporization. The dispersed sulfur trioxide combines with water vapor in the atmosphere, resulting in the formation of tiny droplets of sulfuric acid:

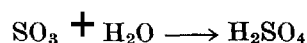

The acid then takes on more water vapor to produce particles of diluted acid which constitute the smoke cloud. Dry sulfur trioxide does not attack metals at ordinary temperatures. At red

heat, sulfur trioxide vapors reacting with metals form metal sulfides and oxides. When the liquid comes in contact with the **skin**, sulfur trioxide causes burns that heal slowly. If water is present, sulfuric acid is formed which is corrosive to metals. As has been indicated, the smoke formed is corrosive to anything affected by sulfuric acid.

#### 7-3.3.4.2 Oleum

Oleum is a solution of sulfur trioxide in sulfuric acid. The agent is dispersed in the same manner as sulfur trioxide. The sulfur trioxide reacts with water vapor in the air; the sulfuric acid thus formed and the sulfuric acid solvent absorb water to give smoke droplets of dilute sulfuric acid.

#### 7-3.3.4.3 Chlorosulfonic Acid

This acid reacts with water similar to  $\text{SO}_3$ . Smoke is produced by dispersion of the acid into the atmosphere by mechanical atomization or thermal vaporization. When the dispersed acid mingles with water vapor, sulfuric acid and hydrochloric acid are produced:

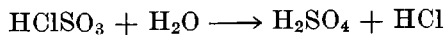

Both acid products take on further water to give droplets of dilute sulfuric and dilute hydrochloric acid. The smoke produced, therefore, is corrosive to anything affected by sulfuric acid or hydrochloric acid and is irritating to the respiratory system, eyes, and skin of exposed personnel.

#### 7-3.3.4.4 Sulfuryl Chloride

Sulfuryl chloride is dispersed in the same manner as sulfur trioxide by mechanical atomization or thermal vaporization. It reacts with water vapor from the atmosphere to give a smoke composed of dilute sulfuric acid and dilute hydrochloric acid droplets. In the presence of moisture, sulfuryl chloride is as corrosive to metal and flesh as is sulfuric acid. Dry sulfuryl chloride is corrosive to those materials affected by sulfuric or hydrochloric acid and will cause burns to the flesh similar to those of sulfuric acid.

#### 7-3.3.4.5 FS Smoke

FS smoke agent consists of a mixture of 45 percent chlorosulfonic acid and 55 percent sulfur trioxide, and is slightly more reactive with water than FM smoke agent (Paragraph 7-3.3.3.1.1). The material can be dispersed by mechanical atomization or thermal vaporization. For producing smoke screens, it is often disseminated from spray tanks carried by aircraft. As the smoke consists of droplets of dilute sulfuric and hydrochloric acid, the smoke is corrosive to anything affected by these compounds. The smoke is very irritating to the nose and lungs and exposure should be avoided. If moisture is present, FS smoke agent is excessively corrosive, and it will cause skin burns.

#### 7-3.3.5 Smoke-Producing Reactions Involving Ammonia or Amines

Most of the reactions described in this subparagraph were at one time used to produce screening smoke. For many reasons they are not presently so used. Some of these systems do not require atmosphere constituents (such as water vapor) to be effective smoke producers and, therefore, may be useful at high altitudes.

#### 7-3.3.5.1 Ammonium and Amine Salts of Volatile Acids

Ammonium and amine salts of a volatile acid such as HCl can be vaporized by heating. For ammonium chloride the reaction is:

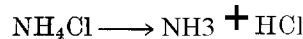

On cooling, recombination occurs. Amine salts, such as aniline hydrochloride, may be used similarly. Ammonium or amine salts have no effect on metals when dry; however, the presence of water may result in some corrosion. These salts can be handled without danger to personnel.

#### 7-3.3.5.2 Metal Chlorides and Ammonia

Metal chlorides may also be reacted with ammonia or amines to produce smoke. The base must combine with the metal chloride just after dispersion. Other bases such as hydrazine may be used in place of ammonia.

##### 7-3.3.5.2.1 Hydrogen Chloride and Ammonia

The reaction of hydrogen chloride with ammonia is similar to the reaction of a metal chloride with ammonia. This two-gas system produces fine particles of solid ammonium chloride. The smoke formed is considered very visible. Gaseous hydrogen chloride is not very corrosive to metal containers when dry; however, when moisture is present, it is quite corrosive. Ammonium chloride smoke is not corrosive to metals. Hydrogen chloride gas is very irritating and, in moderate quantities, it is toxic. Ammonia gas is also toxic in moderate quantities; however, ammonium chloride smoke is harmless.

##### 7-3.3.5.2.2 Titanium Tetrachloride and Ammonia

The reaction between titanium tetrachloride and ammonia is somewhat complex. First, an ammoniate is formed. This ammoniate is hydrolyzed by water vapor from the atmosphere. Ammonia reacts with the hydrochloric acid gas released during hydrolysis of  $\text{TiCl}_4$  to give  $\text{NH}_4\text{Cl}$ . Therefore, the system without water vapor is less effective. The reactions for this process are as follows:

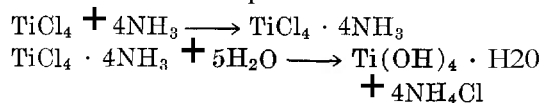

The smoke is a mixture of  $Ti(OH)_4 \cdot H_2O$ , intermediate hydroxy chlorides of titanium, and ammonium chloride particles.

### 7-3.3.5.2.3 Silicon Tetrachloride, Ammonia, and Water

The best proportions are two parts silicon tetrachloride, one part ammonia, and one part water, by weight. The reactions are quite complex; first, an ammoniated silicon tetrachloride is formed while at the same time hydrolysis of the silicon tetrachloride occurs to give  $SiO_2$ ,  $2H_2O$ , and  $HCl$ ; and finally,  $NH_3$  combines with the  $HCl$  to give  $NH_4Cl$ . The reaction sequence is:

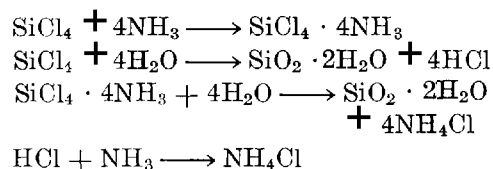

### 7-3.3.5.3 Sulfur Compounds and Ammonia

Sulfur compounds will also react with bases including ammonia and amines. These smoke-producing systems do not require atmospheric constituents to form the smoke particles and, therefore, may be useful at high altitudes.

#### 7-3.3.5.3.1 Sulfur Trioxide and Ammonia or Amines

The smoke is formed by supplying a reactive gas to sulfur trioxide at the time of dispersion. Ammonia and amines have proved successful, and other basic substances, such as hydrazine, hydroxylamine, etc., might be satisfactory. In the case of sulfur trioxide and ammonia, the reactions are:

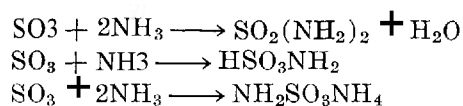

All three reactions occur more or less simultaneously. As far as can be determined, the smoke consists of particles of these products.

#### 7-3.3.5.3.2 Chlorosulfonic Acid and Ammonia or Amines

Ammonia and the amines react readily with  $HClSO_3$  in much the same manner as with sulfur

trioxide; other bases such as hydrazine, hydroxylamine, etc., probably could be substituted. The basic reaction is as follows:

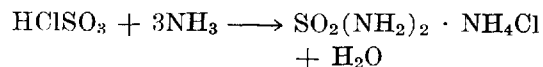

Other reaction products might be formed in addition to the products indicated by this reaction.

#### 7-3.3.5.3.3 Sulfuryl Chloride and Ammonia or Amines

Sulfuryl chloride will react with bases such as ammonia and amines to give a better smoke than is formed with water vapor. The following reactions are for sulfuryl chloride and ammonia:

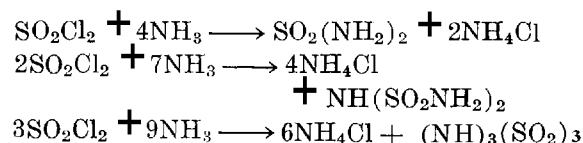

The first reaction gives sulfamide; the second, aminosulfamide; and the third, trisulfamide. Whether the smoke particles are those products or further reaction products is not known.

### 7-3.3.6 Sulfur Smokes

Sulfur smokes consist of small particles of elemental sulfur suspended in the air. Sulfur smokes can be produced by methods similar to those used for the production of oil smokes. In addition, sulfur smokes can be made by intimately mixing sulfur and a suitable fuel. Mixtures which have been used include sulfur, sodium nitrate, and charcoal; sulfur, potassium nitrate and charcoal; and sulfur, ammonium nitrate, and charcoal. The sulfur is present in much larger quantities than in black powder; the latent heat of vaporization and fusion of the sulfur absorbs the heat produced by the reaction and, hence, slows the burning rate. The burning rate for this type of mixture depends on the percentage of sulfur.

### 7-3.3.7 Organic Metallic Compounds

Certain organic metallic compounds can be used for the production of smoke. These compounds are reactive and will burn spontaneously in moist air. The sequence of reaction between an organic metal-

lic compound, water, and oxygen is a highly exothermic reaction between the organic metallic compound and water vapor, yielding a hydrocarbon and metal hydroxide; the heat of this reaction results in the hydrocarbon's burning to form carbon dioxide and water. This reaction for dimethyl zinc is:

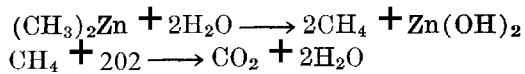

In this case the white particles consist of solid zinc hydroxide particles.

### 7-3.3.8 Comparison of White Smokes

The total obscuring power, TOP,<sup>32</sup> of a smoke is obtained by multiplying the product of volume, in cubic feet of smoke produced per pound of material, and the reciprocal of the smoke layer, in feet, necessary to obscure the filament of a 40-watt Mazda lamp. The TOP for some white smoke agents, at low altitudes where atmospheric constituents are plentiful, is given in Table 7-6.

The so-called "standard smoke" is a smoke of such a density that a 25-candlepower light is just invisible when observed through a layer 100 feet thick. A comparison of some white smoke agents at low altitude, where atmospheric constituents are plentiful, in terms of the amount of smoke agent required to produce 1000 cubic feet of standard smoke, is given in Table 7-7.

All of the TOP and standard smoke measurements were made at low altitude, where atmospheric constituents available for reaction with the primary smoke particles were plentiful. The importance of atmospheric constituents is illustrated in Table 7-8 where the number of grams of smoke formed per gram of smoke agent used is tabulated. It is evident, for the agents compared, that WP yields the greatest weight of aqueous solution in equilibrium with air at 75 percent relative humidity per unit-weight of the smoke agent. The ratio for fog oil is unity (1.0) since the fog oil is not hygroscopic and only the agent is available to form the smoke particles. The values do not take into account ingredients which remain behind as residues or otherwise contribute little to the obscuring power. The absolute values will vary with the relative humidity, but change very little with air

TABLE 7-6  
TOTAL OBSCURING POWER OF  
WHITE SMOKES

<i>Chemical</i>	<i>TOP, ft<sup>2</sup>/lb</i>
White Phosphorus	4600
TiCl <sub>4</sub> + NH <sub>3</sub>	3030
SO <sub>3</sub>	3000
FS	2550
HCl + NH <sub>3</sub>	2500
HC Mixture	2100
SiCl <sub>4</sub> + NH <sub>3</sub>	1960
FM	1900
Oleum	1890
SnCl <sub>4</sub>	1860
PCl <sub>3</sub> + NH <sub>3</sub>	1600
PCl <sub>3</sub> + NH <sub>3</sub>	1800
HClSO <sub>3</sub> + NH <sub>3</sub>	1600
SiCl <sub>4</sub>	1500
HClSO <sub>3</sub>	1400
BM Mixture	1400
Berger Mixture	1250
FM + 1,2-Dichloroethane	1235
SO <sub>2</sub> Cl <sub>2</sub>	1200
Cl <sub>2</sub> + NH <sub>3</sub>	750
AsCl <sub>3</sub>	460
Type-S Mixture	460
Crude Oil	200

TABLE 7-7  
AMOUNT OF SMOKE AGENTS REQUIRED TO  
PRODUCE 1,000 CUBIC FEET OF  
STANDARD SMOKE

<i>Compound</i>	<i>Amount Required, oz</i>
Phosphorus	0.060
FM + NH <sub>3</sub>	0.090
SO <sub>3</sub>	0.094
FS	0.110
HC Mixture	0.120
FM	0.150
Oleum	0.151
Crude Oil	2.000

**TABLE 7-8**  
**AMOUNT OF SMOKE PRODUCED PER UNIT**  
**WEIGHT OF SMOKE AGENT AT**  
**75% RELATIVE HUMIDITY**

<i>Agent</i>	<i>Amount</i>
Fog Oil	1.0 (does not produce aqueous solution)
Zinc Chloride	2.5 (water vapor absorbed)
Ferric Chloride	3.1 (water vapor absorbed)
Aluminum Chloride	5.0 (water-vapor absorbed)
Phosphorus	7.11

temperature at any one value of the relative humidity. Also, the relative results are not changed. It is important to note that these measurements chiefly concern the obscuring or screening power of the smoke and no consideration is given to other factors which might be important for a signal smoke, tracking aid, or tracking and acquisition smoke.

#### 7-3.4 COLORED SMOKES<sup>33</sup>

Colored smokes, like other smokes, can be produced by four basic methods:

- a. Dispersion of finely powdered, colored materials
- b. Chemical reactions resulting in the formation of colored particles
- c. Detonation of an explosive, thereby scattering colored material, or
- d. Volatization and condensation of a colored material.

The first two methods have been found to give smokes of only small volume and dull color. The last two methods, both of which involve the vaporization and condensation of a colored material, have been found feasible only when volatile organic dyes are used as the coloring material. As a result, all colored smoke signals (except black) are based, at present, upon the use of an organic dye.

##### 7-3.4.1 Dyes<sup>34</sup>

Since colored smokes involve vaporization and condensation, constituent dyes are required to be thermally stable and fairly volatile, and to possess

the requisite purity of color when disseminated as a smoke. These properties are closely related to the chemical constitution of the dye. No dye was ever specifically developed for smoke application; only those available were considered and tested. In an early investigation of the thermal stability and volatility of dyes, it was concluded that dyes containing amino or substituted amino groups, but not sulfonic groups, were suitable for the production of colored smokes. These conclusions were confirmed and amplified by British investigators in a systematic survey of common dye-stuffs. The constitutional characteristics which render a dyestuff suitable for the production of colored smoke were found *to* be as follows:

- a. The molecular weight of the dye should preferably be less than 400, but in no case greater than 450.
- b. The dye should be a member of one of the following series: anthraquinone, azine, azo, quinoline, xanthene, or anthrone.
- c. The following groups must be absent: sulfonic, hydrochloride, nitro, nitroso, quaternary ammonium, and oxonium.
- d. The following groups may be present: amino and substituted amino, alkyl, aryl, chloro, bromo, hydroxy, and alkoxy.
- e. The dye must not tend to undergo auto-condensation.

Not all dyes which have the above characteristics will produce satisfactory colored smokes, but some of the many dyes which have been evaluated will produce "excellent" colored smoke clouds. Some of the more satisfactory dyes are listed in Tables 7-9 and 7-10.

In general, the anthraquinone dyes have proved to be superior to all others in producing colored smoke clouds. The azo derivatives have furnished only a few suitable dyes, despite the fact that they constitute the largest class investigated. In no case have the azo dyes been superior to the anthraquinone dyes. The undesirable qualities of the azo dyes are their tendency to flame and their transparency. Among the azine dyes, rosindone and its derivatives give excellent, bright smoke clouds without flaming. Their color range, however, is limited to red and orange. This class of dyes offers

**TABLE 7-9**  
**SOME DYES WHICH HAVE BEEN USED IN BURNING-TYPE**  
**COLORED SMOKE MUNITIONS**

<i>Red Smoke:</i>	<i>Dye(s)</i>
	9-diethylamino-7-phenyl-5-benzo (a) phenazinone. Also known as 9-diethylamino rosindone
	1-methylaminoanthraquinone
	1-(2-methoxyphenylazo)-2-naphthol
	2-quinolyl-2-indandione-1,3 (Rhodamine B) plus 1-(4-phenylazo)-2-naphthol
	2-aminoanthraquinone plus 1-methylaminoanthraquinone
	O-tolylazo-o-tolylazo- $\beta$ -naphthol (Sudan IV); plus 2-quinolyl-2-indandione-1,3 (Rhodamine B); plus auramine hydrochloride
	1-(tolylazoxylylazo)-2-naphthol
<hr/>	
<i>Green Smoke :</i>	
	1,8-di-p-toluidinoanthraquinone
	1,4-di-p-toluidinoanthraquinone
	1-methylamino-4-p-toluidinoanthraquinone plus auramine hydrochloride
	1,4-di-p-toluidinoanthraquinone plus dimethylaminoazobenzene
	1,4-di-p-toluidinoanthraquinone plus auramine hydrochloride
	1,4-di-p-toluidinoanthraquinone with quinophthalone (quinoline yellow)
<hr/>	
<i>Orange Smoke :</i>	
	1-aminoanthraquinone
	1-amino-8-chloroanthraquinone plus quinizarin
	1-(4-phenylazo)-2-naphthol
	9,10-dianilinoanthracene plus phthaloperinone
	1-(4-phenylazo)-2-naphthol plus 9,10-dianilinoanthracene
<hr/>	
<i>Orange-Red Smoke :</i>	
	1-(4-nitrophenylazo)-2-naphthol
<hr/>	
<i>Yellow Smoke:</i>	
	Auramine hydrochloride
	1-(4-dimethylaminophenylazo)-2-naphthol
	1-(4-phenylazo)-2-naphthol (Sudan I) plus either auramine hydrochloride or quinophthalone (quinoline yellow)
	N,N-dimethyl-p-phenylazoaniline

TABLE 7-9 (cont'd)

<i>Blue Smoke:</i>	<i>Dye(s)</i>
	1-hydroxy-4-p-toluidinoanthraquinone
	Indigo
	1-amino-2-bromo-4-p-toluidinoanthraquinone
	1-amino-2-methyl-4-p-toluidinoanthraquinone (Alizarin Sapphire, Blue R. Base)
	1,4-dimethylaminoanthraquinone
	1-hydroxy-4-p-toluidinoanthraquinone
	1-methylamino-4-p-toluidinoanthraquinone
	N-(p-dimethylaminophenyl)-1,4-naphtholquinonimine
<i>Violet Smoke:</i>	
	1,4-diaminoanthraquinone
	1,4-diamino-2,3-dihydroanthraquinone
	1,5-di-p-toluidinoanthraquinone
	1-methylamino-4-p-toluidinoanthraquinone plus 2-quinolyl-2-indandione-1,3 (Rhodamine B)
	1-methylamino-4-p-toluidinoanthraquinone plus 1,5-di-p-toluidinoanthraquinone

TABLE 7-10  
SOME DYES WHICH HAVE BEEN USED IN EXPLOSIVE-TYPE  
COLORED SMOKE MUNITIONS

<i>Red Smoke:</i>	<i>Dye(s)</i>
	1-(2-methoxyphenylazo)-2-naphthol
	1-methylaminoanthraquinone (Celanthrene Red)
<i>Yellow Smoke :</i>	
	2,4-diaminoazobenzene (Chrysoidine G, base)
	Auramine Hydrochloride
<i>Green Smoke:</i>	
	1,4-di-p-toluidinoanthraquinone (Quinizarin Green) plus quinophthalone (Quinoline Yellow, base) in the ratio of 65/35
	1-4-di-p-toluidinoanthraquinone plus auramine hydrochloride

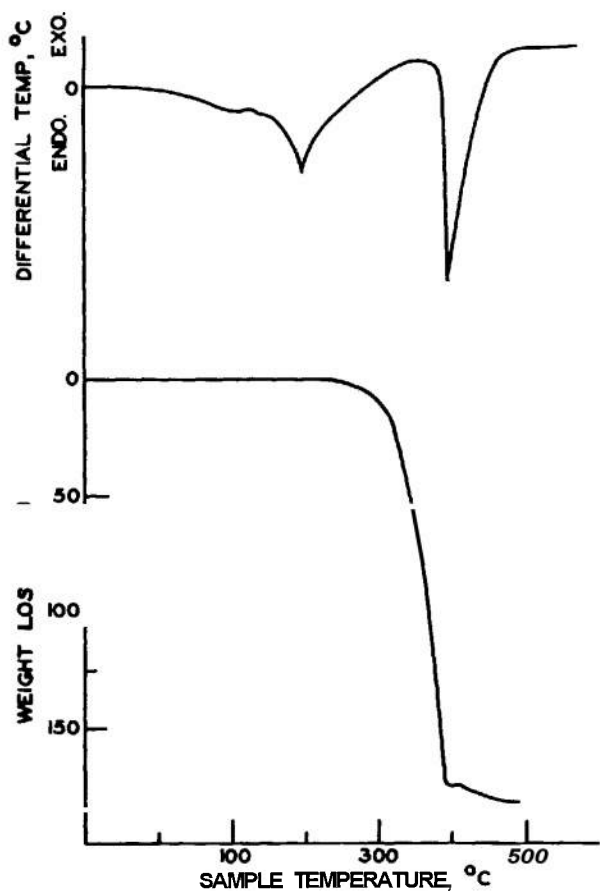

NOTE: X-AXIS TEMPERATURE REPRESENTS SAMPLE TEMPERATURE FOR THE DTA CURVE AND FURNACE TEMPERATURE FOR THE TGA CURVE

Figure 7-70. Differential Thermal Analysis and Thermogravimetric Analysis Curve for 1,8-dihydroxyanthraquinone

the most promise for future investigation. Several dyes containing sulfonic groups have been tested and, with only one exception, found to be non-volatile; this exception is the ammonium salt of 2-(2-hydroxy-1-naphthylazo)-1-naphthalenesulfonic acid which gives a fair red smoke. Lakes and other pigments have been found to give no smoke when used in pyrotechnic mixtures. For satisfactory results, the purity of dyes used must be **high**, since organic impurities are usually volatile and tend to give a muddy-colored smoke. Inorganic impurities are generally either sodium chloride or sodium sulfate and, while they in themselves **do** not change the color of the smoke, large quantities slow down the **burning** rate of the smoke mix-

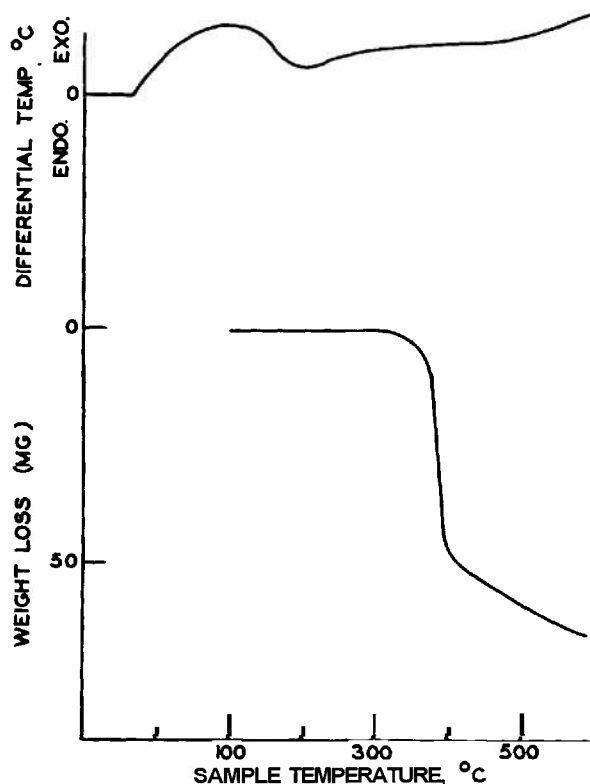

NOTE: X-AXIS TEMPERATURE REPRESENTS SAMPLE TEMPERATURE FOR THE DTA CURVE AND FURNACE TEMPERATURE FOR THE TGA CURVE

Figure 7-71. Differential Thermal Analysis and Thermogravimetric Analysis Curve for 1,4-di-p-toluidinoanthraquinone

ture and decrease the quantity of smoke available.

Although organic dyes have been widely used in burning- and burst-type colored smoke markers and signals, very little is known about their chemical, physical, and thermodynamic properties at elevated temperatures. In making a choice of dyes, the thermodynamic properties of the compounds—such as heats of fusion, vaporization or sublimation, decomposition, equilibrium vapor pressures, rates of vaporization, and the temperatures at which these phenomena occur—are important. For example, if the compound is thermally stable but has a relatively low vapor pressure *so* that relatively high temperatures are required for its vaporization, the fuel-oxidant to dye ratio required for optimum vaporization of the dye will not allow the munition to contain the amount of dye necessary to produce an acceptable volume of colored smoke. If the dye can be vaporized at a low tem-



perature but the differential between the temperature for vaporization and the temperature for decomposition is not large, the dye to fuel ratio increases but the possibility of decomposition of the dye is also greatly increased. In general, therefore, the dyes utilized must be thermally stable and vaporize without decomposition at intermediate temperatures.

The volatilization properties of organic dyes proposed for use in pyrotechnic smoke mixtures were studied by differential thermal analysis (DTA) and thermogravimetric techniques.<sup>35,36</sup> The dyes evaluated by these techniques can be classified into three groups.

The materials in Group 1 exhibit an initial weight loss, the rate of which increases as a function of temperature. They do not have an inflection in their thermogravimetric curves until they have undergone a weight loss of 65 to 100 percent. An examination of the DTA curves for these materials generally indicates an endothermal reaction followed by an exothermal trend, and, finally, an endothermal region. Over these temperature ranges the following phenomena were observed: fusion, the evolution of small quantities of vapor, and boiling.

Compounds in Group 2 show an initial weight loss of from 30 to 50 percent, followed by a sharp break in the thermogravimetric curve, after which the rate of weight loss is generally slower. The thermogravimetric curves for Group 3 materials indicate an initial weight loss of only 2 to 20 percent prior to an inflection.

In general, the materials in Group 1 possess the thermal properties of stability and volatility required for satisfactory functioning in pyrotechnic smoke items. For most of these materials, as shown in Figure 7-10 for 1,8-dihydroxyanthraquinone, no weight loss occurs before fusion; once the boiling point is approached the rate of weight loss increases uniformly with temperature. The absence of a break or point of inflection in the thermogravimetric curves for the Group 1 materials, is indicative in this case, of vaporization. Group 2 materials do not vaporize appreciably. As shown in Figure 7-11, 1,4-di-p-toluidinoanthraquinone, a standard dye used for the production of blue smoke, exhibits approximately a

30 percent initial weight loss during which a point of inflection occurs. It is postulated that this material reacts to form an effective color product in the temperature region of 350°C to 440°C. If, however, the temperature of the dye is not carefully controlled, it decomposes further to form a volatile red product. In general, the dyes in Groups 2 and 3 do not perform satisfactorily. They fail to vaporize appreciably and the irregularities in the differential thermal analysis curves indicate the occurrence of reactions and/or decomposition. The temperature produced by the reaction must be sufficiently high to rapidly vaporize the dye but not excessive so as to cause decomposition of the dye, or flaming. A cooling agent such as sodium or potassium bicarbonate may be added to the fuel mix to regulate the burning rate. Binders are sometimes used to produce a composition that is easier to handle and process.

The properties and structures of certain selected dyes are as follows:

**Dyes Selected by the British as the Best Agents Available for the Production of Colored Smokes by Explosion, Using PETN (pentaerythritol tetranitrate) for the Explosive:**

**Red** : o-methoxybenzene-azo-β-naphthol (Brilliant Fat Scarlet)

**Molecular Weight:** 270

**Components:** o-Anisidine → β-naphthol  
C<sub>17</sub>H<sub>14</sub>N<sub>2</sub>O<sub>2</sub>

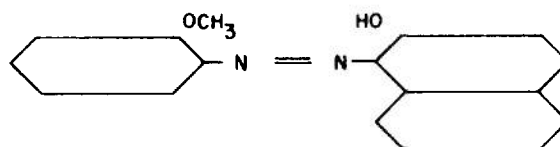

**Properties, Description:** Red paste; separates from glacial acetic acid in red crystalline powder, m.p. 180°C. H<sub>2</sub>O—insoluble. Alcohol—red solution on boiling. H<sub>2</sub>SO<sub>4</sub>—bluish-red solution, red precipitate on dilution.

**Commercial Names:** Oil Vermilion (W), Sudan R (A), Brilliant Fat Scarlet B (SC1), Pigment Purple (MLB).

Yellow : 2,4-Diaminoazobenzene (Chrysoidine G, base)

Molecular Weight: 212

Components: Aniline — m-Phenylenediamine  
 $C_{12}H_{13}N_4Cl$

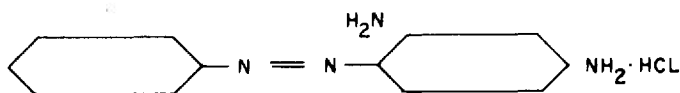

*Properties, Description:* Reddish-brown crystalline powder or large black shining crystals with a green luster (latter contain the homologs from o- and p-toluidine).  $H_2O$ —orange-brown solution. Alcohol—orange-brown solution. Ether—insoluble. HCl to aqueous solution: brown-yellow gelatinous precipitate consisting of hair-like needles. NaOH—red-brown precipitate of chrysoide base, m.p.  $117^\circ C$ , sparingly soluble in  $H_2O$ , soluble in ether, alcohol, or benzene.  $H_2SO_4$ —brown-yellow solution, cherry-red to orange solution on dilution.

*Commercial Names:* Chrysoidine G (CAC), (DuP), (Gy), (SCI), (MLy), (By), (GrE), Chrysoidine Base (CHC), (CV), (JWL), (LBH), (W), (NAC).

*Green:* Mixture of 1,4 di-pi-toluidinoamino-anthraquinone (Quinzarin Green) and quinophthalone (Quinoline Yellow, base) in the ratio of 65/35.

Molecular Weight: 418 (Quinzarin Green)

Components: leuco-Quinzarin (or 1,4-Dichloroanthraquinone) and p-Toluidine.

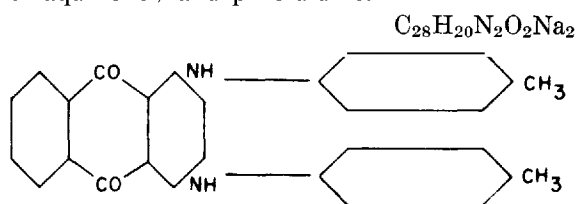

*Properties, Description:* Bluish-green powder.  $H_2O$ —bluish-green solution. HCl—dark soluble precipitate. NaOH—dark soluble precipitate.  $H_2SO_4$ —dull reddish-blue solution, bluish-green solution on dilution.

*Commercial Names:* Alizurol Cyanine Green E, G extra, K (BAC), Alizarin Cyanine Green F paste and powder, EF, G extra, 3G, E powder

and paste (By), Alizarin Brilliant Green EF, G cone. (LBH), Solway Green E, EF, GM (SDC), formerly Kymric Green E, G extra (SDC).

A mixture of 55% 1,4-dimethylaminoanthraquinone (Brilliant Blue G, M.W. 266) and 45% Quinophthalone (Quinoline Yellow Base) is also used to produce green smokes of an emerald green color. The mixture of Quinzarin Green and Quinoline Yellow (base) produces a color approaching the green of the spectrum.

*Quinoline Yellow:* Mixture of symmetrical quinophthalone or 2-quinolyindandione, with small quantities of iso-quinophthalone, or unsymmetrical quinophthalone or 2-quinaldylenephthalide.

Molecular Weight: 273

Components: Quinaldine and phthalic anhydride.  
 $C_{18}H_{11}NO_2$

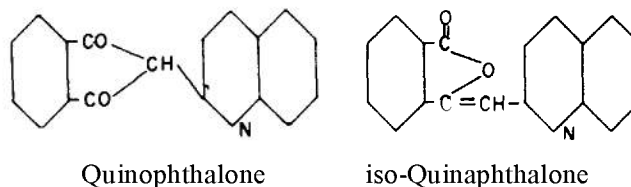

*Properties, Description:* Yellow powder, crystallizes from boiling alcohol in thin golden-yellow needles, m.p.  $240^\circ C$ ; iso-quinophthalone is more soluble in alcohol and crystallizes in orange-yellow prisms, m.p.  $187^\circ C$ .  $H_2O$ —insoluble. Alcohol—sparingly soluble with a yellow color.  $H_2SO_4$ —yellowish-red solution, yellow flocculent precipitate on dilution.

*Commercial Names:* Quinoline Yellow spirit-soluble (H), (S), (RF), (A), (B), (By), (K), Brilliant Fat Yellow C (SCI). Quinophthalone

### Dyes Selected by the U.S. as Satisfactory Agents for Producing Burning Type Smokes:

*Yellow:* Auramine—Hydrochloride of tetramethyldiamino-diphenyl-ketonimine.

Molecular Weight: 267

Components: Tetramethyldiamino-diphenyl methane, ammonium chloride, and sulfur.

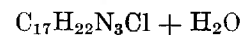

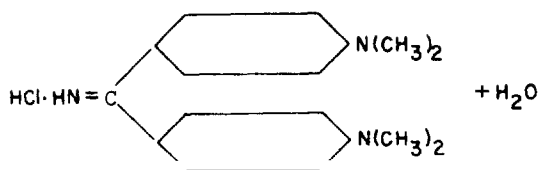

*Properties, Description:* Sulfur-yellow powder.

H<sub>2</sub>O—bright yellow solution, readily decomposed on boiling. Alcohol—yellow solution. NaOH—white precipitate of Auramine base, m.p. 130°C, soluble in ether. H<sub>2</sub>SO<sub>4</sub>—colorless solution, pale yellow color on dilution.

*Commercial Names:* Auramine (H), (Gy), (S), (SCI), (StD), (A), (B), (By), (C), (L), (MLB), (tM);

Auramine O (BDC), (DuP), (Gy), (S), (SCI), (StD), (B)

O cone. (LBH), DuP) NO (CN)

II (BDC), (LBH), (S), (A), (B) 2 (StD)

NAC (NAC) OE (B)

OO extra cone. (SCI), (StD) extra cone. (MLB)

Fat Yellow A (SCI)

Canary Yellow (Gr E)

*Green:* 1,4-di-p-toluidinoanthraquinone with auramine hydrochloride

*Red:* 1-Methylaminoanthraquinone (Celanthrene Red)

*Molecular Weight:* 237

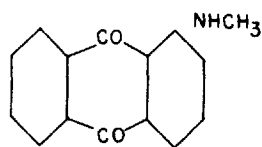

*Commercial Name:* Duranol Red B (BDC)

**Products Currently Used for Colored Smoke Compositions:**

*Green:* 1,4-di-p-toluidinoanthraquinone and Auramine

*Red:* 1-Methylamino anthraquinone

*Yellow:* Beta-naphthalene-azo-dimethylaniline and Auramine



*Molecular Weight:* 275

### 7-3.4.2 Fuels<sup>33,37</sup>

The number of combustibles that are satisfactory in colored smoke mixtures is very limited and includes sulfur, thiourea, and sugars such as lactose, sucrose, and dextrose. Dextrin, starch, and lampblack can be used, in part, to replace the above materials but results have not always been satisfactory. Among the sugars, lactose has been found to be the most desirable. Sucrose and dextrose (corn sugar) have the disadvantage of being somewhat hygroscopic, and a small percentage of starch is usually added to enable their handling under conditions of high humidity. Potassium chlorate and sugar are usually mixed in about equal parts. Although such a fuel mixture contains an excess of sugar, the excess has been found necessary to secure proper action of the smoke ingredients. For slow-burning colored smoke mixtures, a fuel composed of sulfur and potassium chlorate, in stoichiometric proportions, has been found to be highly satisfactory.

With either sucrose or lactose as fuel, the gaseous products formed are carbon dioxide and water vapor:

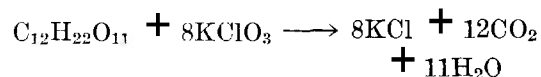

Lactose would yield an additional mole of water when oxidized by potassium chlorate.

### 7-3.4.3 Oxidants<sup>33,37</sup>

A large number of fuel-oxidant mixtures have been investigated. The oxidizing agents studied include chlorates, perchlorates, permanganates, nitrates, nitrites, peroxides, and oxides. However, the only satisfactory oxidizing agent found thus far, despite its friction-sensitivity, has been potassium chlorate. Potassium nitrate might be used to replace potassium chlorate in colored smoke mixtures if a very stable dye such as 1-methylaminoanthraquinone is used. Even with this dye, only slow-burning grenades have been produced using potassium nitrate. With most dyes, a nitrate is always less desirable than a chlorate, and

nitrates have been found unsatisfactory with auramine hydrochloride and indigo. Nitrates, therefore, should not be substituted for the chlorates in colored smoke munitions unless a special condition, such as a shortage of chlorate, makes it necessary.

#### 7-3.4.4 Cooling Agents<sup>38,37</sup>

Cooling agents may be added to regulate the burning rate of the fuel and to lower the temperature sufficiently to prevent excessive decomposition of the dye. With resultant decolorization or strong flaming. The best cooling agents have been found to be sodium bicarbonate or potassium bicarbonate. Potassium bicarbonate decomposes at a higher temperature than sodium bicarbonate and is, therefore, more suitable for fast-burning types of colored smoke mixtures. Sodium bicarbonate has been found better for the slower-burning mixtures. Other cooling agents which have been investigated are the ammonium salts such as the chloride, bromide, oxalate, carbonate, sulfate, sulfite, thiocyanate, and tartrate. These have been found to work with varying degrees of success but most of them have the disadvantage that, upon condensation, they form white smokes which dilute the color of the dye smoke. Inert diluents—such as Fuller's earth, calcium carbonate, and kaolin—have often been added to smoke mixtures to retard the burning rate and reduce flaming.

#### 7-3.4.5 Binders

Graphite, zinc oxide, and linseed oil have been used for some applications but in most cases no binder has been used and the composition has been consolidated under pressure. Because of the problems associated with the loading of smoke mixtures, some work has been directed toward the development of a plastic-bonded smoke mixture.<sup>38</sup> None of the plastic-bonded smokes have been standardized. The use of a binder such as polyvinyl acetate<sup>39</sup> would be advantageous because: (1) it contributes few undesirable qualities to the smoke, (2) it binds smoke mixtures into a hard, tough, nonbrittle mass having excellent water and shock resistance, (3) it produces a formulation which withstands high and low temperature surveillance with negligible change, (4) it is safe, nontoxic, and

easily handled, (5) it is available at low cost and in quantity, and (6) it eliminates the necessity for consolidation under pressure. Other plastics which have been considered include various monomers and polymers of acrylic and vinyl plastics, polyamines, and epoxy-type resins.

#### 7-3.4.6 Evaluation of Colored Smokes

Of the original colored smokes used; red, green, yellow, and violet were found to be the most suitable. These colors were most perceptible against the various backgrounds and displayed optimum visibility at a considerable distance. Further, they were least affected by the light-scattering properties of the atmosphere. Blue was found unsuitable for signaling purposes because of excessive effect of light scatter.

A number of different methods have been used to measure the quality of a colored smoke. In many cases, they were merely observed at various distances. More quantitative methods involve the use of Munsell color charts<sup>40</sup> and colorimeters. Extended chroma Munsell color charts developed by the National Bureau of Standards were successfully used in measuring the color of colored smoke clouds.<sup>41</sup> Munsell color cards were designed and used in field measurements. The Munsell color data were converted to the internationally accepted C.I.E. system of color representation for evaluation.

#### 7-3.4.7 Sensitivity of Colored Smoke Mixtures<sup>42</sup>

Most of the colored smoke mixtures which have been used, with the exception of the yellow smoke mixture containing auramine, may be considered satisfactorily insensitive to friction and impact under the conditions encountered in normal loading operations. Yellow smoke mixtures containing auramine are impact-sensitive, and require more care in handling and loading. Smoke mixtures containing 1-(4-dimethylaminophenylazo)-2-naphthol are markedly less sensitive to impact and friction than mixtures containing auramine. Ignition test results show that colored smoke compositions can be ignited by hot surfaces—and no doubt by open flames and other direct heat sources—of comparatively low temperature. Following ignition, dust

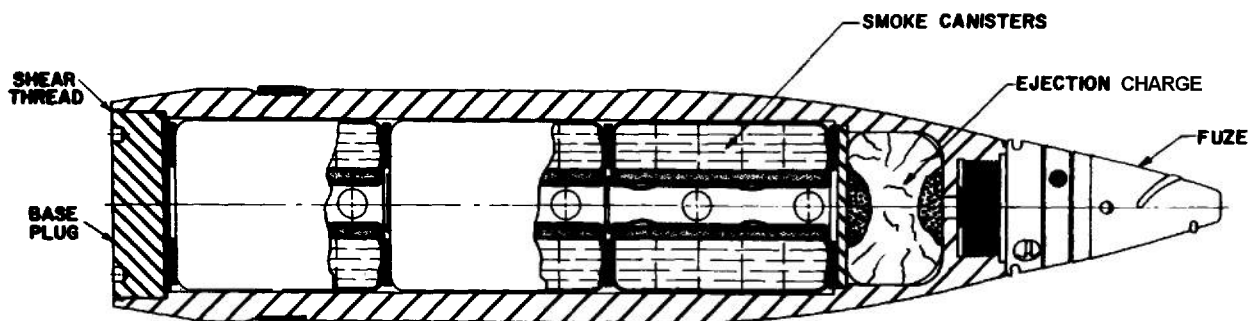

Figure 7-12. 105 mm M84 Colored Smoke Projectile

clouds or dispersions of these powders are capable of producing dust explosions.

#### 7-3.4.8 Toxicity of Colored Smoke Mixture

As standardized, the colored smoke clouds are nontoxic in ordinary field concentrations. In general, toxic materials should not be employed as ingredients in signaling and screening munitions. It has been reported<sup>43</sup> that certain dyes exhibit carcinogenic characteristics which should be guarded against when they are used. The problem in determining whether or not a dye is a carcinogenic hazard is complex because the products of metabolism of the dye must also be considered for carcinogenic activity even though the original dye may be harmless. The hazards involved in handling carcinogenic materials are not in the quantities involved but in the frequency of exposure no matter how small the dosage.

One of the smoke dyes of great interest to the Army, Indanthrene Golden Yellow GK, has been tested and found to be not carcinogenic but it is closely related to 3,4,8,9-dibenzpyrene (Indanthrene Golden Yellow without the two oxygens) which is known to be a very potent carcinogen. If this compound should be present or formed by a process of reduction as an impurity in even as small a quantity as .01% it would present a considerable hazard. Red dye, 1-methylaminoanthraquinone, has not been tested for carcinogenicity but has the possibility of being a potential liver carcinogen. Two other smoke dyes, Sudan Orange R (1-phenylazo-2-naphthol) and 1-(2-methoxyphenylazo)-2-naphthol are reported as carcinogenic. Blue dye, 1,4-diamino-2,3-dihydroanthraquinone, has not been tested but is expected to be relatively safe by its structure.

Diethylamino Rosindone might undergo metabolic reduction in the body to yield carcinogenic  $\beta$ -naphthylamine. Green smoke dye 1,4-di-p-toluidinoanthraquinone is on the current approved list for drugs and cosmetics (Food and Drug Administration).

Before experimentation with a particular dye is undertaken, it is important to gain all available information pertaining to the potential hazards involved in its use.

#### 7-3.4.9 Typical Devices

Colored smoke mixtures have been used in hand and rifle grenades, mortar and artillery projectiles, float signals, rockets, smoke bombs, and similar munitions. As shown in Figure 7-12, a smoke composition is often contained in a canister which is ejected from the projectile when the fuze functions. The ejection charge ignites the starter mixture which, in turn, ignites the smoke mixture. This device contains three canisters which are ejected from the base of the projectile on air burst. Each canister contains from 380 to 410 grams of either yellow, red, green, or violet smoke mixture. Many other smoke-producing items, such as grenades, etc., are also based on the canister as shown in Figures 7-13 and 7-14. Characteristics of these devices are given in Tables 7-11 and 7-12.

#### 7-3.4.10 Direct Volatilization of Dye

Colored smoke clouds are also produced by direct volatilization of dye in the thermal generator-type munitions (separate dye and fuel compartments). The dye should preferably be a crystalline compound and have a melting point

**TABLE 7-11**  
**CHARACTERISTICS OF TYPICAL EJECTION-TYPE COLORED SMOKE DEVICES**

<i>Characteristic</i>	<i>4.2-in. Colored Smoke Projectile</i>	<i>M18 Colored Smoke Hand Grenade</i>
Dimensions, in.	Overall—4.2 dia by 20 long (approx.) Canister—3.7 dia by 9.3 long (approx.)	2.5 dia by 4.5 high  Six smoke emission holes
Weight	Projectile—23 to 24.5 lb Ejection charge—25 g Grade A black powder 35 g infallible powder	11.5 oz make mixture
Fuze	M54 Time and SQ	M201A1 1.2 to 2 sec delay
Propellant	M6	
Loading Pressure	18000 lb/in. <sup>2</sup>	
Smoke Duration		50-90 sec
Applications	Time-fuzed for air-burst sig- naling and/or base-ejected for marking ground positions. Uses red, yellow, green or violet colored smoke for sig- naling, spotting, or outlining a position	Grenade is thrown or launched from a rifle or ear- bine by using a M2A1 gre- nade projection adapter. Uses red, yellow, green, or violet colored smoke for sig- naling
Visibility	Very good	Easily identified at altitude of 10,000 feet against back- ground of green and brown; clearly seen at a distance of three miles.

under 150°C, or a melting point of 100°C, when mixed with a small proportion of a melting-point depressant such as diphenylamine (less than 25 percent is necessary). The dye should be stable for three to four minutes at temperatures of 50°C to 100°C above its melting point. The dye 1-(4-phenylazo)-2-naphthol—called commercially by a variety of names, i.e., duPont Oil Orange, Sudan Orange, Federal Smoke Orange-E, and 1-(O-tolylazo)-2-naphthol (Calco Oil Orange Y-293)—produces good orange smoke clouds but varies in quality depending upon the commercial source. The dye 1-xylylazo-2-naphthol (Calco Oil Scarlet II, National Oil Scarlet 6-G) gives a much redder cloud but the addition of 20 percent duPont Oil

Yellow N (N, N-dimethyl-p-phenylazoaniline) gives a satisfactory color. The dye duPont Oil Yellow N produces a brilliant yellow colored smoke. Mixtures of blue and orange dyes, such as Calco Oil Orange Y-293 and Calco Oil Blue NA (1,4-diamylaminoanthraquinone), give a brown-orange or brown-rose cloud. Blue smoke results from using only 25 percent Calco Oil Orange Y-293. With a 75 percent mixture of National Oil Scarlet 6-G and Calco Oil Blue NA, the color has the appearance of a mixture of orange and violet or tan and violet. Larger percentages of scarlet result in a rose-colored cloud and smaller percentages result in blue smoke. A mixture of the dye 1-(2-methoxyphenylazo)-2-naphthol (Federal Signal Red A)

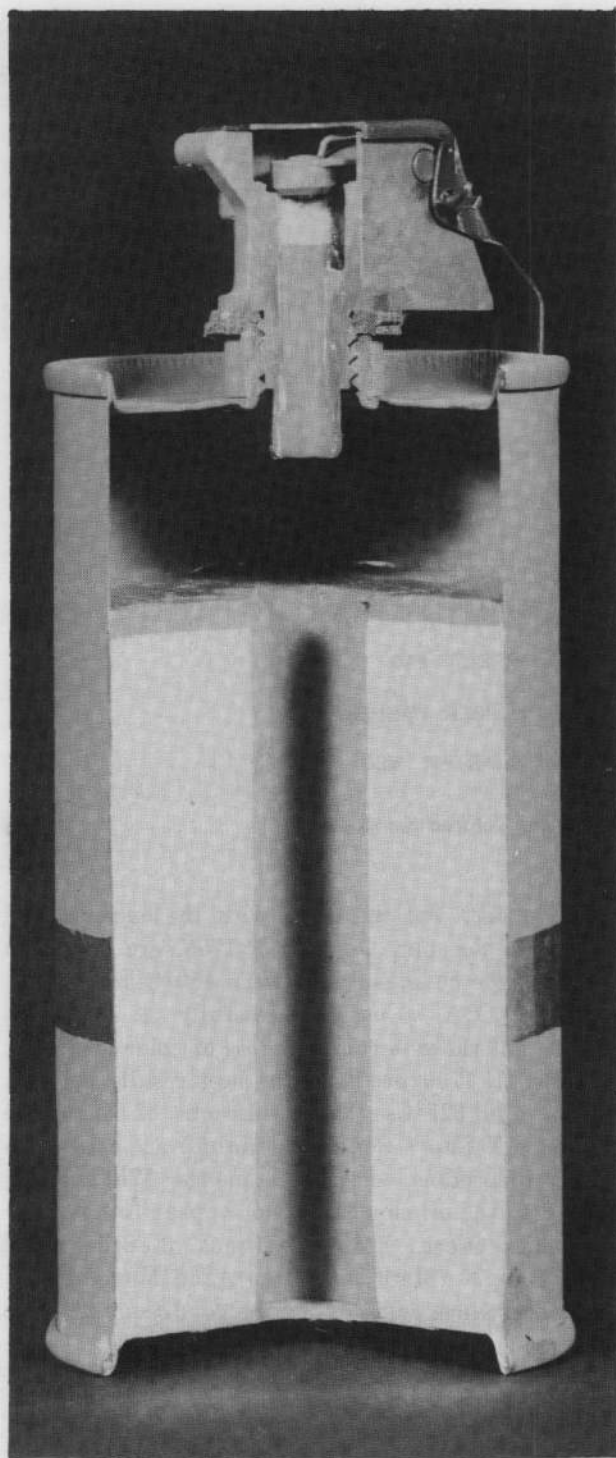

Figure 7-13. M18 Colored Smoke Hand Grenade

with Calco Oil Blue NA gives a blue-gray cloud for all proportions tried. The dye Monoazo Red (duPont) gives much the same result.

#### 7-3.4.11 Colored Smoke from Solution of Dyes<sup>32</sup>

A third method of producing colored smoke clouds is by volatilization of the dyestuff from solution, usually by means of the hot exhaust of a motor. Early attempts to use colored smoke trails from the exhaust of an airplane engine employed a mixture of SAE-10 oil (flushing oil) and dye. Carbon tetrachloride has also been used in place of the oil, but is not recommended. Ten pounds of dye are mixed with two gallons of the oil to a smooth, pasty solution and then diluted with an additional five gallons of flushing oil. The dyes recommended are Oil Purple AB, Oil Blue-Green O, Oil Red EGN, and Oil Orange 2311 [1-(4-phenylazo)-2-naphthol].

The principal difficulty is the low solubility of the dyes in oil. A solvent composed of one part of carbon tetrachloride to four parts of SAE-10 oil is not satisfactory due to congealing of the solution. The use of hexachlorobutadiene as solvent, however, is considered successful in that the resulting mixture of dyestuff and solvent is extremely fluid and has no tendency to congeal. Azo dyes are found to be the most satisfactory. These are Oil Yellow (4-(0-tolylazo)-2-methylaniline), Oil Scarlet 6-G (1-xylylazo-2-naphthol), Oil Red O, and Oil Green Q-261.

Further tests indicate that solutions of dye in hexachlorobutadiene, diluted with SAE-10 oil, are unsatisfactory due to the gelling of the mixture within a few hours after mixing. Solutions prepared with fifteen to eighteen pounds of dye, two to three gallons of trichlorobenzene, and three gallons of SAE-10 oil are found to be satisfactory. No gelling of the solution is noted after six to eight days.

Oil smoke is also produced in a wide variety of colors and shades using the following oil-soluble dyes either as such or in admixture:

- Oil Blue NA (1,4-diamylaminoanthraquinone)
- Oil Blue RA [N-(p-dimethylaminophenyl)-1,4-naphthoquinonimine]
- Oil Red N-1700 [1-(tolylazoxylylazo)-2-naphthol]

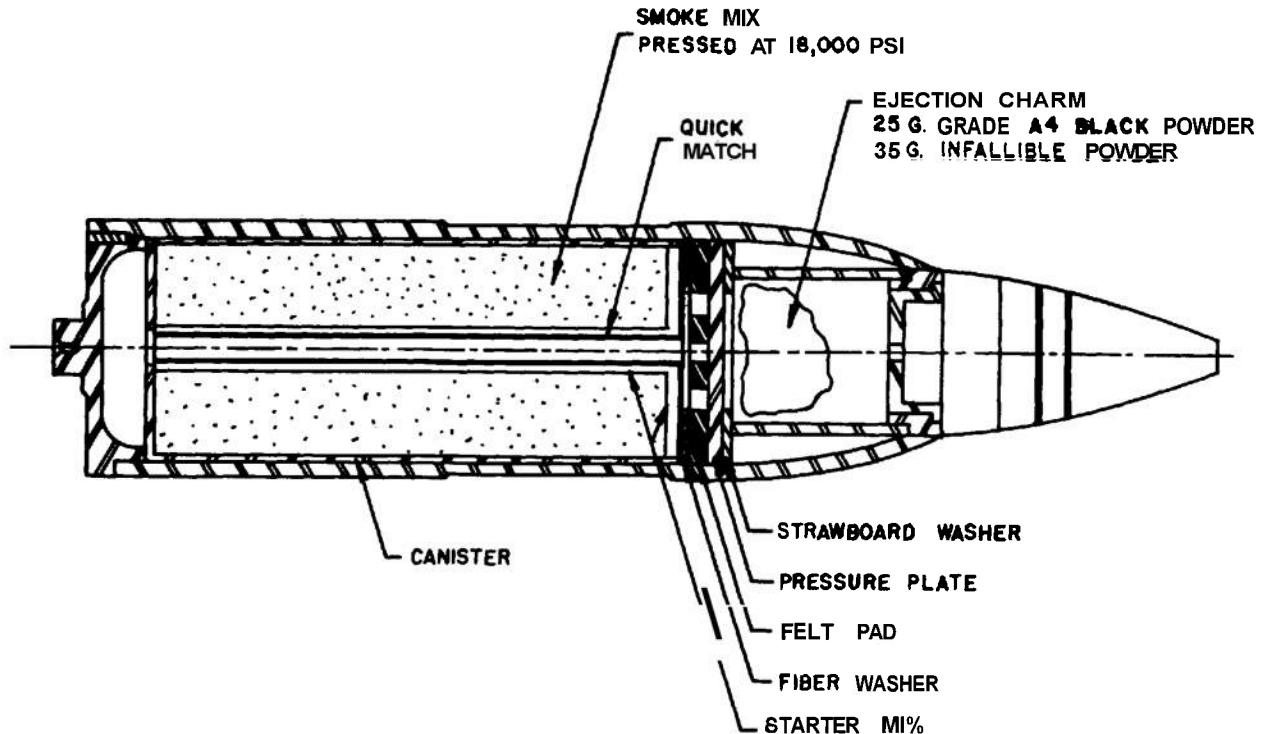

Figure 7-74. 4.2-in. Colored Marker Projectile, Colored Smoke, E75

Oil Orange Y-293 [1-(o-tolylazo-2-naphthol)  
 Oil Yellow 7463 [N, N-dimethyl-p-phenylazo-  
 aniline]  
 Gas Green CG (1,4-di-p-toluidinoanthraquin-  
 one)

The maximum effect with the minimum quantity of dye is obtained by adding about five percent of the dye dissolved and/or suspended in oil dispersed through a point-type spray nozzle. The dye is added at a point in the oil smoke exhaust where the temperature can be varied between 400°C and 800°C. By controlling the temperature within approximately 50°C limits, a fairly constant shade is obtained with each dye. By using different temperature bands, variations are obtained in the shade of smoke produced from a given dye. The efficiency of color production, however, appears to be equivalent in all cases. The shade changes which result from variations of temperature are due, at least in part, to the changes in color of the

basic smoke. All the dyes, with the exception of Oil Blue RA and Oil Red N-1700, are found to produce the best results between 450°C and 700°C. Oil Blue RA is used successfully at 400°C to 550°C but shows a complete loss of color at 560°C. Oil Red N-1700 produces the best results between 550°C and 625°C. Water solutions of Auramine and Red Y Supra Conc. (Safranin) are used effectively to produce colored oil smokes. Water spray added to the oil cloud does not appear to have any injurious effect. Water solutions of Blue FFB, New Blue N (Methylene Blue), and Magenta XX fail to produce color under the conditions of these experiments.

#### 7-3.4.12 Black Smoke<sup>33,44</sup>

Black dyes do not, in general, give satisfactorily dense black smokes. Such smokes are generally produced by burning of hydrocarbons such as phenanthrene or anthracene. The addition of an-



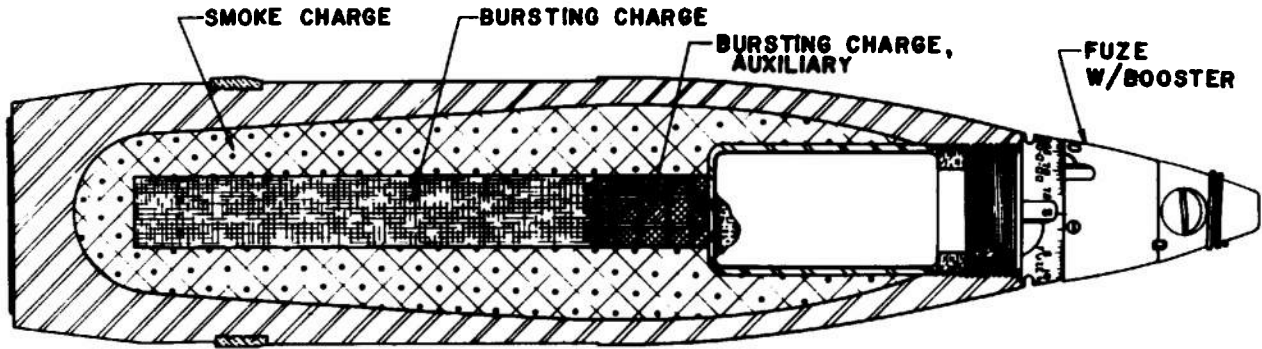

Figure 7-75. 705 mm M1 Colored Marker Projectile

TABLE 7-12  
BASIC DIFFERENCES BETWEEN THE COLORED MARKER AND  
BASE-EJECTION SMOKE PROJECTILES FOR 105 mm GUN

	<i>HE Colored Marker</i>	<i>Base-Ejection Colored Smoke</i>
Build-up period of colored cloud	Effective instantaneous	Over a period of from 1-2 min
Density of cloud	Highly saturated	Wispy
Duration of cloud	Average 65-85 sec	75-120 sec
Size of cloud	Approx. 40 × 60 ft	Streamer approx. 4 ft across
Lethality of round	May be lethal (fragments)	Nonlethal
Fuzing of round	MTSQ & VT fuzing	MTSQ fuzing only
Weight of round	Equal to 105 mm HE round	Lighter than 105 mm HE round
Ranging of round	Similar to 105 mm HE round	Canister impacts up to 150 ft away from impact point of projectile body

thracene or naphthalene to HC smoke mixtures also produces black smoke. The oxidizing agent generally used is potassium perchlorate.

#### 7-3.4.13 Explosive-Type Colored Smoke Bursts<sup>45,46</sup>

In addition to the colored smoke dissemination methods discussed in the previous paragraphs, there is the method that produces its effect through the action of an explosive burster. Both propellants and high explosives are used for this purpose. For example, a colored smoke burst can be obtained by using a mixture of approximately equal parts of dye and EC powder. This mixture is detonated

with an appropriate detonator or booster charge, the resulting explosion giving a large puff of colored smoke. Colored smoke clouds are also obtained from a mixture of a salt and a dye disseminated by a central high-explosive burster of baratol, amatol, 60 mm ignition powder, Composition B, or others. The use of a salt diluent is one procedure for producing controlled nuclei on which the dye may condense. Cast or pressed dye, along with a central burster, is also used to produce colored clouds. The basic performance differences between dissemination of colored smoke by an item using an explosive burster and by a munition using burning-type smoke mixtures are tabulated

in Table 7-12. The 105 mm Colored Marker Projectile, referred to in the table, is shown in Figure 7-15.

The dyes that are satisfactory for dissemination by an explosive charge include the same dyes as those used in the burning-type colored smoke munitions. Also, many azo-type dyes which do not perform well in burning smoke munitions give very good smoke clouds when disseminated by EC powder. Among the best dyes for explosive munitions are 1-(2-methoxyphenylazo)-2-naphthol for red, 1-(4-nitrophenylazo)-2-naphthol and 1-(4-phenylazo)-2-naphthol for orange, and 4-phenylazo-m-phenylenediamine for yellow.

**7-3.4.13.1 Propellant Bursters<sup>47</sup>**

Several propellants have been studied for use as bursters, the EC powder mentioned above showing the greatest promise. Various methods of loading EC powder and dye in a projectile have been tried as follows:

- a. Mixing the dye and EC propellant powder intimately before loading the projectile,
- b. Coating the projectile wall with melted dye and placing the EC powder in the central cavity,
- c. Filling the projectile with melted dye and then drilling out a core for EC powder, and
- a. Loading the projectile with approximately equal increments of dye and EC powder in alternate layers.

The last method, in which alternate layers of dye and EC powder are used, was found to be the best. The alternate-layer method of loading with EC powder was found to be superior to bursters of either TNT or tetryl. The burster explosive used is a mixture similar to amatol loadings, consisting of 27.8 percent ammonium picrate and 72.2 percent ammonium nitrate.

**7-3.4.13.2 High Explosive Bursters**

Sufficient explosive must be included in the burster charge so that when it is detonated, it will break the projectile apart without causing excessive dispersion and/or burning of the filler. The products of explosion must be compatible with the dye used. The color of many dyes is influenced by

acidity. For many dyes baratol has proved to be satisfactory. The method for determining the weight of a burster used in colored marker projectiles was derived by assuming that the energy of the explosive charge is proportional to the strain energy required to burst the projectile. In order to simplify calculations, conversion factors and constants are included in a dimensionless factor *K*. The weight of burster required is given by the empirical formula :

$$w_e = KW(Y + U)eK' \tag{7-7}$$

where

*w<sub>e</sub>* = weight of explosive required (including initiator), g

*K* = a constant,  $11.4 \times 10^{-6}$  to  $11.4 \times 10^{-5}$ , depending on caliber and explosive used (the exact *K* can be found by empirical evaluation only)

*W* = weight of steel components of projectile (excluding fuze and base), lb

*Y* = yield stress of projectile steel, psi

*e* = strain elongation at fracture, %

*U* = ultimate strength of projectile steel, psi

*K'* = ratio of caloric value of a standard explosive to explosive to be used. For instance, if value of tetryl is 1,100 cal/g and baratol is 900 cal/g the formula would be:

$$w_e = KW(Y + U)e(11/9)$$

Burster charges designed by this method have functioned favorably. The quantity  $(Y + U)e$  is roughly equal to twice the strain energy absorbed by one cubic inch of steel.

**7-3.4.14 Typical Mixtures**

Typical colored smoke mixtures, including a few white and black smokes, are shown in Table 7-13.

**7-3.5 AGENT AEROSOLS**

Because of their nature, a detailed discussion of the dissemination of agent aerosols is beyond the scope of this handbook. In general, the principles and methods applicable to the dissemination of a colored smoke agent are applicable to the dissemination of an agent aerosol.

**TABLE 7-13**  
**TYPICAL SMOKE COMPOSITIONS**

<i>Type</i>	<i>Composition, %</i>	<i>Application</i>	<i>Typical Devices</i>
<b>WHITE:</b>			
HC-Type C	Hexachloroethane	45.5	Screening and
	Zinc Oxide	47.5	
Modified HC	Aluminum (grained)	7.0	Signaling
	Hexachlorobenzene	34.4	Screening
	Zinc Oxide	27.6	and
	NH <sub>4</sub> ClO <sub>4</sub>	24.0	Signaling
	Zinc Dust	6.2	
Modified HC	Laminae w/catalyst	7.8	
	Dechlorane	33.9	Screening
	Zinc Oxide	37.4	and
	NH <sub>4</sub> ClO <sub>4</sub>	20.5	Signaling
Plasticized White Phosphorus (PWP)	Laminae w/catalyst	8.2	
	White Phosphorus	65.0	Screening
	Plasticizer	35.0	(antipersonnel)
	(Neoprene 100parts)		
	(Carbon 75 parts)		
	(Zylene 44 parts)		
	(Litharge 15parts)		
<b>BLACK:</b>			
	KClO <sub>3</sub> (200 mesh)	52.0	Screening
	Anthracene (40 mesh)	48.0	
<b>COLORED:</b>			
Red	Dyc-MIL D-3718	40.0	Signaling
	KClO <sub>3</sub>	24.0	
	NaHCO <sub>3</sub>	17.0	
	Sulfur	5.0	
	Polyester resin	14.0	
Red	1-methylamino (AQ)*	45.0	Signaling
	1,4-di-p-toluidino (AQ)*	3.0	
	KClO <sub>3</sub> (23μ)	35.0	
	Sugar, fine (11μ)	17.0	
Red	1-(methoxyphenylazo)-2-naphthol	80.0	Air marker
	NaCl	20.0	Marking
			ground targets

\* (A&)—Anthraquinone

TABLE 7-13 (cont'd)

<i>Type</i>	<i>Composition, %</i>		<i>Application</i>	<i>Typical Devices</i>
Red (plastic)	Dye (R)	40.0	Signaling	Improved grenade fillings
	KClO <sub>3</sub>	28.0		
	NaHCO <sub>3</sub>	23.0		
	Sulfur	5.0		
	Polyvinyl acetate in ethyl acetate	3.0		
Yellow	Benzanthrene	32.0	Signaling	Rocket type parachute ground signals
	Indanthrene GK	15.0		
	KClO <sub>3</sub> (23μ)	30.0		
	Sugar, fine (11μ)	20.0		
	NaHCO <sub>3</sub> (20μ)	3.0		
Yellow	Auramine Hydrochloride	40.0	Air marker, etc.	90 mm yellow marker projectile
	NaCl	60.0		
Yellow (plastic)	Dye (Y)	40.0	Signaling	Improved grenade fillings
	KClO <sub>3</sub>	29.8		
	NaHCO <sub>3</sub>	23.2		
	Polyvinyl acetate in ethyl acetate	7.0		
Green	1,4-di-p-toluidino (AQ)*	28.0	Signaling	Rocket type parachute ground signals
	Indanthrene GK (golden yellow)	12.0		
	KClO <sub>3</sub> (23μ)	35.0		
	Sugar, fine (11μ)	23.0		
	NaHCO <sub>3</sub> (20μ)	2.0		
Green (plastic)	Dye (G)	40.0	Signaling	Improved grenade fillings
	KClO <sub>3</sub>	26.0		
	NaHCO <sub>3</sub>	24.0		
	Sulfur	6.0		
	Polyvinyl acetate w/ethyl acetate	4.0		
Violet	Violet dye, Spec. MIL-D-3691	47.5	Signaling	Rocket type parachute ground signals
	KClO <sub>3</sub> (25μ)	28.0		
	Sugar, fine (10μ)	18.0		
	NaHCO <sub>3</sub> (20μ)	4.5		
	Asbestos	2.0		
Orange	8-chloro-1-amino (AQ)*	39.0	Signaling	Grenades
	Auramine	6.0		
	KClO <sub>3</sub>	22.3		
	Sulfur	8.7		
	NaHCO <sub>3</sub>	24.0		

\* (AQ)--Anthraquinone

## REFERENCES

1. A. M. Prentiss, *Chemicals in War*, McGraw-Hill Book Co., Inc., N. Y., 1937.
2. K. F. Sawyer, "Screening Smokes," *Thorpe's Dictionary of Applied Chemistry*, Vol. X, 4th Ed., Longmans, Green, London, 1950, p. 781.
3. H. L. Green and W. R. Lane, *Particulate Clouds: Dusts, Smokes and Mists*, D. Van Nostrand Co., London, 1957.
4. *History of Research and Development of the Chemical Warfare Service in World War II*, Reinhold, N. Y., 1948.
5. L. P. Brophy, D. M. Syndham, R. C. Cochrane, *The Chemical Warfare Service: From Laboratory to Field*, Department of Army, Washington, D. C., 1959.
6. W. A. Noyes, Jr., Ed., *Chemistry, Science in World War II Series*, Little, Brown and Co., 1948.
7. John A. Martin, "Combat Smoke in Korea," *Armed Forces Chemical Journal*, 7 October 1953.
8. B. E. Kleber and E. I. Byrnes, "Make Smoke," *Armed Forces Chemical Journal*, 6 April 1943.
9. S. L. A. Marshall, *Infantry Operations and Weapons Usage in Korea During the Winter of 1950-51*, Report ORO-R-13, Department of Army, Washington, D. C., 27 October 1953.
10. W. W. Cavell, T. Stevenson, *Smoke Tracers, Caliber .50*, Frankford Arsenal, Philadelphia, Pa., November 1951.
11. *BAT Antitank Weapon and Ammunition*, Frankford Arsenal Report 1080, Frankford Arsenal, Philadelphia, Pa.
12. W. A. Noyes, Jr., *Military Problems with Aerosols and Non-Persistent Gases*, Summary Technical Report of Division 10, Department of Army, Washington, D. C., 1946.
13. G. Mie, *Ann der Phys.* **25**, 377 (1908).
14. M. H. P. P. Yevick, *The Toxicity of Combustion Products of Pyrotechnics*, CWL-TM-26-12, Army Chemical Warfare Laboratories, Edgewood Arsenal, Maryland, May 1960.
15. *Toxic Hazards Associated with Pyrotechnic Items*, OP 2793, Naval Ordnance Laboratory, Bureau of Naval Weapons, Washington, D. C., May 1959.
16. N. Irving Sax, *Dangerous Properties of Industrial Materials*, 2nd Ed., Reinhold, 1963, Library of Congress Catalog Card No. 63-20370.
17. David W. Fassett, Don D. Irish, Eds., *Industrial Hygiene and Toxicology*, Vol. 11, Interscience Publications, 1963.
18. *AN-M7 Fuel Block Program*, Report O-2148U, Olin Mathieson Chemical Corporation, New Haven, Connecticut, April 15, 1961 (DDC-AD 271 (878)).
19. L. F. Young, W. M. Conway, *The T36E1 Steel-Wool White Phosphorus (SWP) Smoke Grenade*, Picatinny Arsenal Technical Report 2618, Picatinny Arsenal, Dover, N. J., November 1959.
20. R. D. Kracke, *Improved Phosphorus Smoke*, TCR-13, Technical Command, Army Chemical Center, Edgewood Arsenal, Maryland, March 1949.
21. H. Zislin, *Stabilization of Red Phosphorus*, Frankford Arsenal Report 660, Frankford Arsenal, Philadelphia, Pa., October 1945.
22. M. S. Silverstein, G. Nordblom, *Stabilization of Commercial Red Phosphorus*, Frankford Arsenal Report 206, Frankford Arsenal, Philadelphia, Pa., April 1943.
23. M. S. Silverstein, G. F. Nordblom, C. W. Ditrach, and J. J. Jackabein, "Stable Red Phosphorus," *Industrial and Engineering Chemistry* **40**, 301 (1948).
24. D. L. Elkstedt, *Laboratory and Flight Tests of Chemical Tracking Aids*, AFMDC-TR-58-2, Air Force Missile Development Center, Holloman Air Force Base, New Mexico, July 1958 (DDC-AD 23 736).
25. H. B. Elkins, *HC Smoke: Properties of Zinc Oxide Affecting the Burning Characteristics of HC Smoke Mixtures*, TDMR-729, Edgewood Arsenal, Md.
26. L. Finkelstein, *The Chemistry of HC Smoke Mixtures*, Army Chemical Laboratories, Edgewood Arsenal, Md.

## REFERENCES (cont'd)

27. G. Weingarten, *Long Range Research on Pyrotechnics Development of an Improved Smoke Composition for Activator, Practice, M1*, Picatinny Arsenal Technical Report 1799, Picatinny Arsenal, Dover, N. J., November 1950.
28. Jack DeMent, *Composition for Smoke Production*, U.S. Patent 2,995,526, August 1961.
29. J. E. Andrews, Jr., B. Werbel, *Smokes*, Picatinny Arsenal, Dover, N. J., May 1962.
30. J. E. Andrews, Jr., K. G. Carlon, W. W. Reaves, *Evaluation of a Plastic-Bonded HC Smoke Composition for the M8 Grenade*, CRDLR-3065, Army Chemical Laboratories, Edgewood Arsenal, Maryland, April 1961.
31. S. Gordon and C. Campbell, "Preignition and Ignition Reactions of the Pyrotechnic System  $Zn-C_6Cl_6-KClO_4$ ," *Fifth Symposium on Combustion*, Reinhold Publishing Co., N. P., 1955.
32. S. Grundemeier, *Survey of Literature of Chemical Tracking Aids*, HADC-TR-57-7, Air Force Missile Development Center, Holloman Air Force Base, New Mexico, August 1957 (DDC-AD 135 001).
33. L. Finkelstein, *Colored Smokes, Vol. 12 of History of Research and Development of the Chemical Warfare Service in World War II*, Army Chemical Center, Edgewood Arsenal, Maryland, 31 December 1945 (DDC-ATI 207 451).
34. G. D. Heath, *Pormation of Coloured Smoke Clouds, Part 1 of Review of Suitable Organic Dye Stuff*, PR 2547, Great Britain, April 1943.
35. D. Anderson, S. Gordon, D. Edelman, *Thermogravimetric Determination of the Energies of Activation Volatilization*, Picatinny Arsenal Technical Note 16, Picatinny Arsenal, Dover, N. J., 1948.
36. D. Anderson, S. Gordon, D. Edelman, *Differential Thermal Analysis and Thermogravimetric Analysis of Organic Dyes*, Picatinny Arsenal Technical Note 25, Picatinny Arsenal, Dover, N. J., 1958.
37. ORDWES Quarterly Report 1948-8, Wesleyan University, Middletown, Connecticut, May 1948.
38. W. W. Reaves, J. H. Hassmann, *Investigation of a Long Burning Plastic-Bonded, Colored Smoke Mixture*, CWLR 2339, Army Chemical Laboratories, Englewood Arsenal, Maryland, January 1960 (DDC-AD 233 750).
39. N. J. Wilkaitis, *Research and Development of Flammable Plastic for Colored Smoke Use*, Army Chemical Laboratories, Edgewood Arsenal, Maryland, October 1956 (DDC-AD 137 748).
40. *Munsell Book of Color*, Munsell Color Co., 10 East Franklin St., Baltimore, Maryland.
41. Chemical and Radiation Laboratories Report 610, Edgewood Arsenal, Maryland.
42. S. J. Magram, *Sensitivity of Colored Smoke Mixtures*, TDMR-547, Edgewood Arsenal, Maryland.
43. A. F. Talyrek, *The Toxicity of Certain Dyes in Current Use*, Picatinny Arsenal, Dover, N. J., May 1964.
44. *Development of a Black Smoke Candle for Signal Purposes*, EACD-376, Edgewood Arsenal, Maryland, March 1926.
45. T. Advokat, *Colored Marker Shell M107 (155 mm)*, Picatinny Arsenal Technical Note 140, Picatinny Arsenal, Dover, N. J., September 1956 (DDC-AD 108 297).
46. T. Advokat, *HE Colored Marker Shell for M29 and T72 Mortars (81 mm M362)*, Picatinny Arsenal Technical Report 2664, Picatinny Arsenal, Dover, N. J., January 1960 (DDC-AD 314 621).
47. G. D. Heath, *Production of Colored Smokes by Explosive Dispersion*, PTP-147, Great Britain, January 1950.

# ENGINEERING DESIGN HANDBOOK SERIES,

Listed below are the Handbooks which have been published or are currently being printed. Handbooks with publication dates prior to 1 August 1962 were published as 20-series Ordnance Corps pamphlets. AMC Circular 310-38, 19 July 1963, redesignated those publications as 706-series AMC pamphlets (i.e., ORDP 20-138 was redesignated AMCP 706-138). All new, reprinted, or revised Handbooks are being published as 706-series AMC pamphlets.

<u>General and Miscellaneous Subjects</u>		<u>Ballistic Missile Series (continued)</u>	
No.	Title	No.	Title
106	Elements of Armament Engineering, Part One, Sources of Energy	283	Aerodynamics
107	Elements of Armament Engineering, Part Two, Ballistics	284(C)	Trajectories (U)
108	Elements of Armament Engineering, Part Three, Weapon Systems and Components	286	Structures
110	Experimental Statistics, Section 1, Basic Concepts and Analysis of Measurement Data	<u>Ballistics Series</u>	
111	Experimental Statistics, Section 2, Analysis of Enumerative and Classificatory Data	140	Trajectories, Differential Effects, and Data for Projectiles
112	Experimental Statistics, Section 3, Planning and Analysis of Comparative Experiments	150	Interior Ballistics of Guns
113	Experimental Statistics, Section 4, Special Topics	160(S)	Elements of Terminal Ballistics, Part One, Introduction, Kill Mechanisms, and Vulnerability (U)
114	Experimental Statistics, Section 5, Tables	161(S)	Elements of Terminal Ballistics, Part Two, Collection and Analysis of Data Concerning Targets (U)
121	Packaging and Pack Engineering	162(S-RD)	Elements of Terminal Ballistics, Part Three, Application to Missile and Space Targets (U)
134	Maintainability Guide for Design	<u>Carriages and Mounts Series</u>	
135	Inventions, Patents, and Related Matters (Revised)	340	Carriages and Mounts--General
136	Servomechanisms, Section 1, Theory	341	Cradles
137	Servomechanisms, Section 2, Measurement and Signal Converters	342	Recoil Systems
138	Servomechanisms, Section 3, Amplification	343	Top Carriages
139	Servomechanisms, Section 4, Power Elements and System Design	344	Bottom Carriages
170(C)	Armor and Its Application to Vehicles (U)	345	Equilibrators
270	Propellant Actuated Devices	346	Elevating Mechanisms
290(C)	Warheads--General (U)	347	Traversing Mechanisms
331	Compensating Elements (Fire Control Series)	<u>Guns Series</u>	
<u>Ammunition and Explosives Series</u>		250	Guns--General
175	Solid Propellants, Part One	252	Gun Tubes
176(C)	Solid Propellants, Part Two (U)	<u>Military Pyrotechnics Series</u>	
177	Properties of Explosives of Military Interest, Section 1	186	Part Two, Safety, Procedures and Glossary
178(C)	Properties of Explosives of Military Interest, Section 2 (U)	187	Part Three, Properties of Materials Used in Pyrotechnic Compositions
179	Explosive Trains	189	Part Five, Bibliography
210	Fuzes, General and Mechanical	<u>Surface-to-Air Missile Series</u>	
211(C)	Fuzes, Proximity, Electrical, Part One (U)	291	Part One, System Integration
212(S)	Fuzes, Proximity, Electrical, Part Two (U)	292	Part Two, Weapon Control
213(S)	Fuzes, Proximity, Electrical, Part Three (U)	293	Part Three, Computers
214(S)	Fuzes, Proximity, Electrical, Part Four (U)	294(S)	Part Four, Missile Armament (U)
215(C)	Fuzes, Proximity, Electrical, Part Five (U)	295(S)	Part Five, Countermeasures (U)
242	Design for Control of Projectile Flight Characteristics	296	Part Six, Structures and Power Sources
244	Section 1, Artillery Ammunition--General, with Table of Contents, Glossary and Index for Series	297(S)	Part Seven, Sample Problem (U)
245(C)	Section 2, Design for Terminal Effects (U)	<u>Materials Series*</u>	
246	Section 3, Design for Control of Flight Characteristics (out of print)	149	Rubber and Rubber-Like Materials
247	Section 4, Design for Projection	212	Gasket Materials (Nonmetallic)
248	Section 5, Inspection Aspects of Artillery Ammunition Design	691	Adhesives
249	Section 6, Manufacture of Metallic Components of Artillery Ammunition	692	Guide to Selection of Rubber O-Rings
<u>Automotive Series</u>		693	Magnesium and Magnesium Alloys
355	The Automotive Assembly	694	Aluminum and Aluminum Alloys
356	Automotive Suspensions	697	Titanium and Titanium Alloys
<u>Ballistic Missile Series</u>		698	Copper and Copper Alloys
281(S-RD)	Weapon System Effectiveness (U)	699	Guide to Specifications for Flexible Rubber Products
282	Propulsion and Propellants	700	Plastics
		721	Corrosion and Corrosion Protection of Metals
		722	Glass

\*The Materials Series is being published as Military Handbooks (MIL-HDBK-) which are available to Department of Defense Agencies from the Naval Supply Depot, 5801 Tabor Avenue, Philadelphia, Pennsylvania 19120.